

# 195

ДЕТАЛЕЙ

# 10

ВАРИАНТОВ  
СБОРКИ

# ИНСТРУКЦИЯ MECHANICS



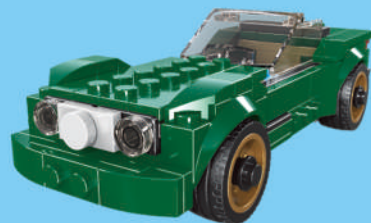
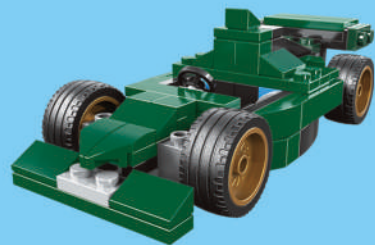
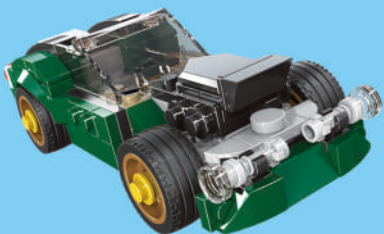

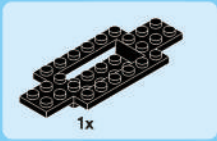
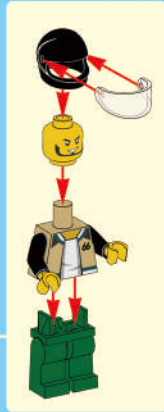

1

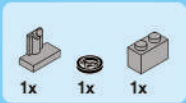
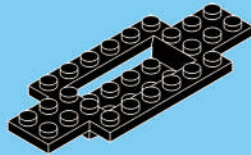

2

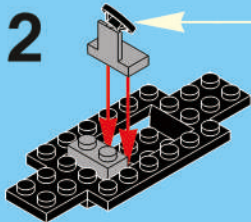

2

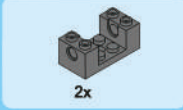
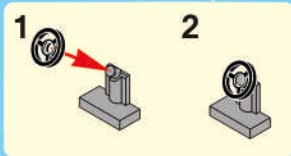

3

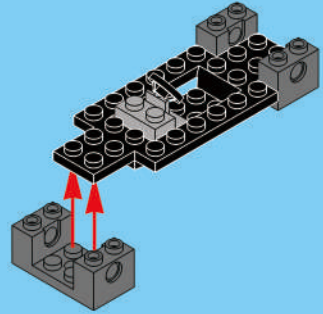

4

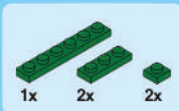
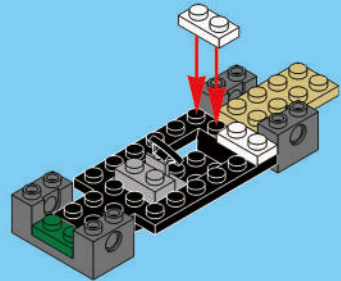

5

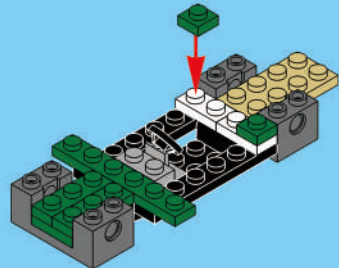



6

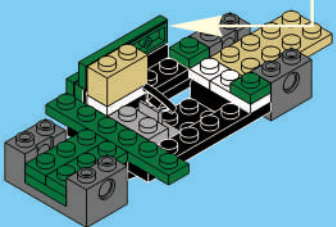
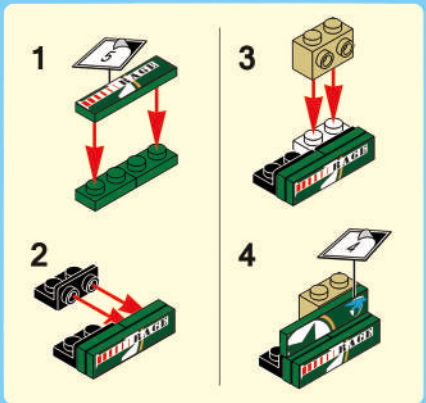

7

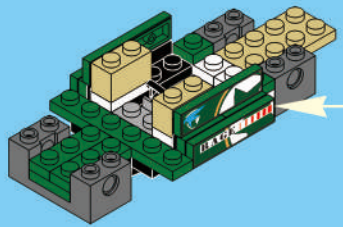
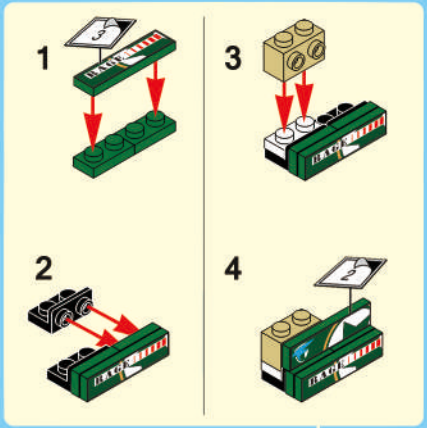

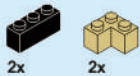

8

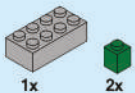
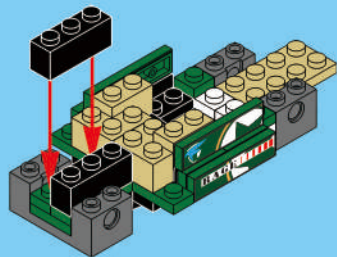

9

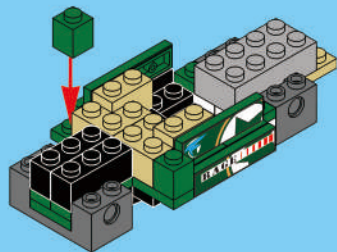

10

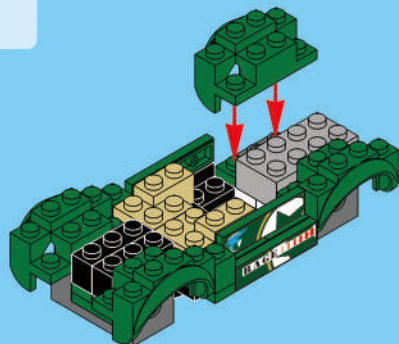

11

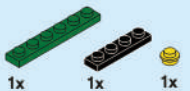
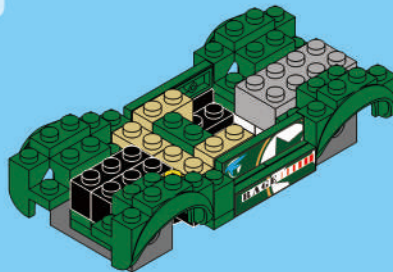

12

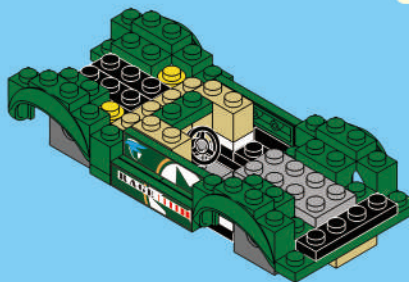
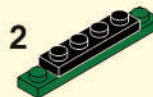
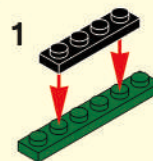

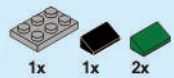

13

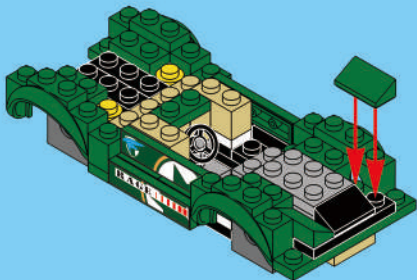

14

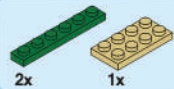
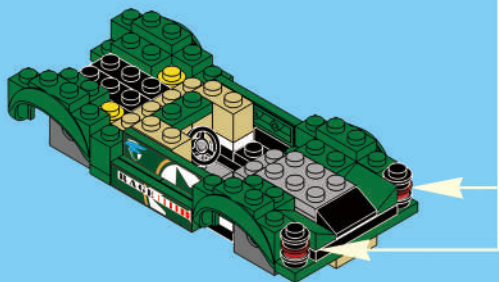

15

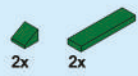
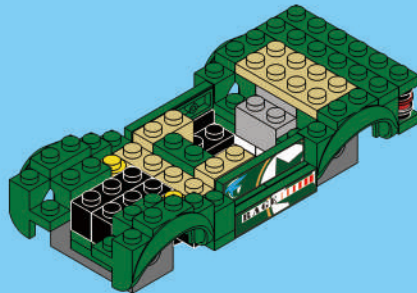

16

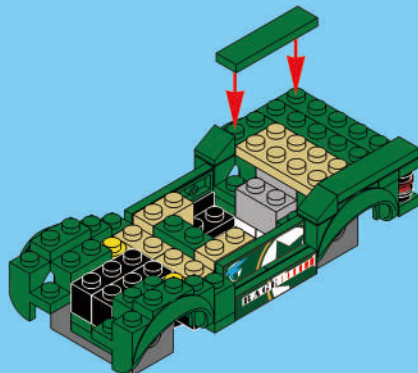



17

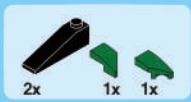
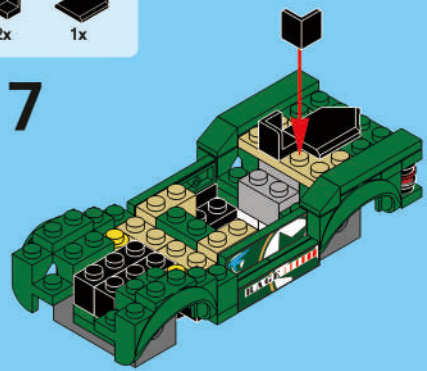

18

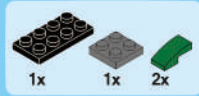
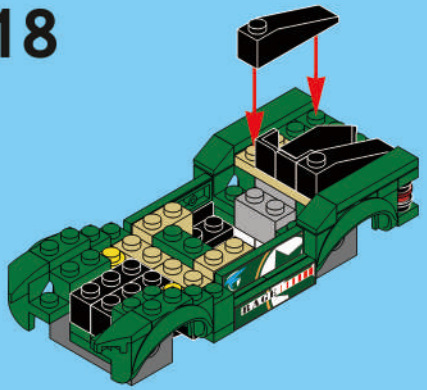

19

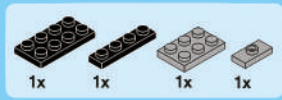
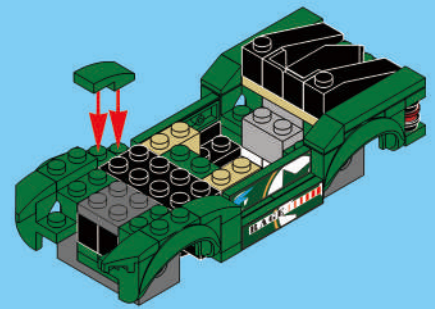

20

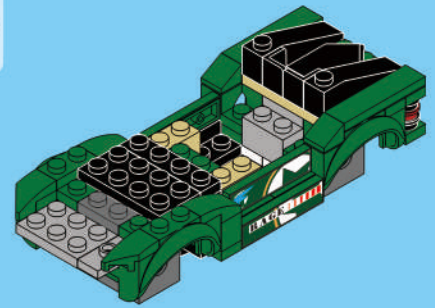

21

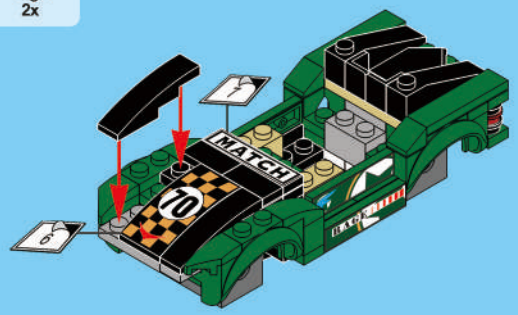



22

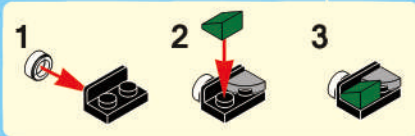
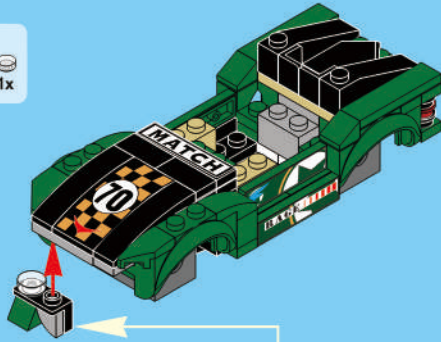

23

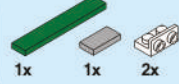
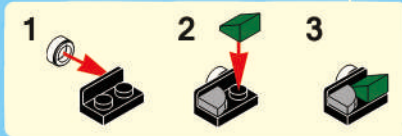
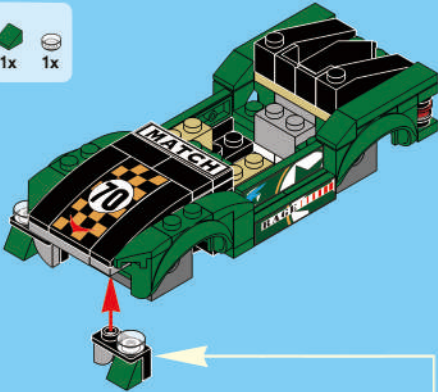

24

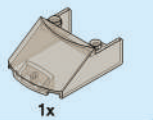
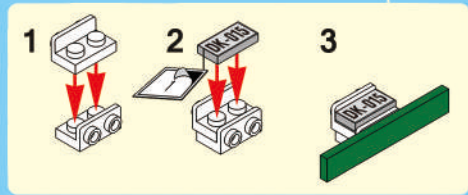
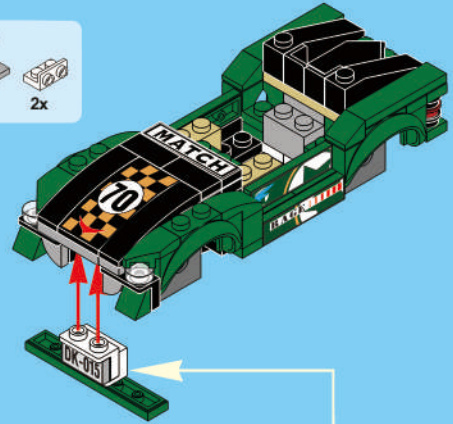

25

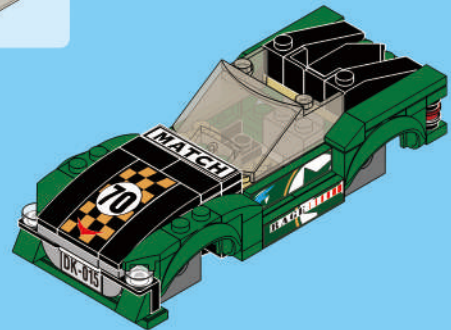



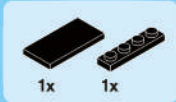

26

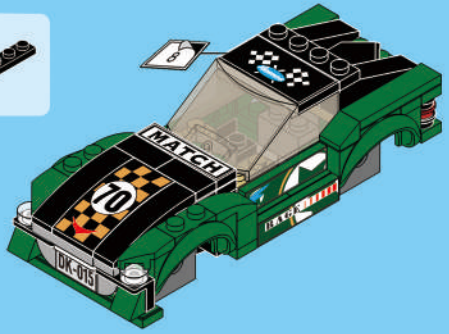

27

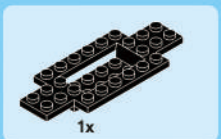
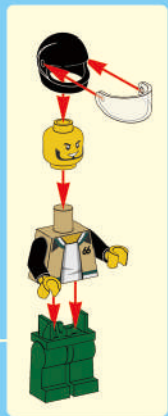
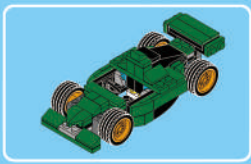
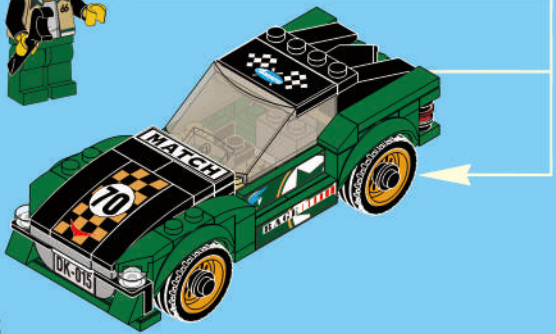
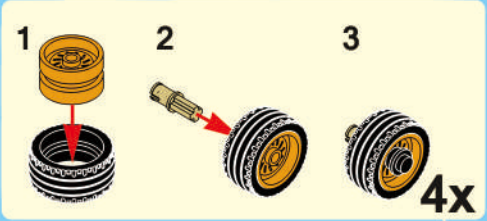

1

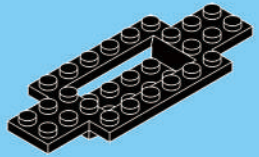

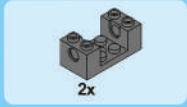

2

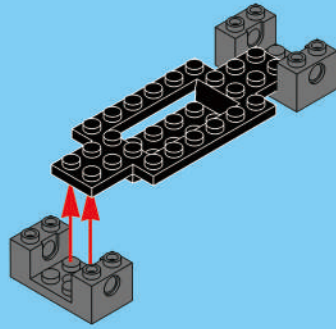

3

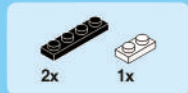
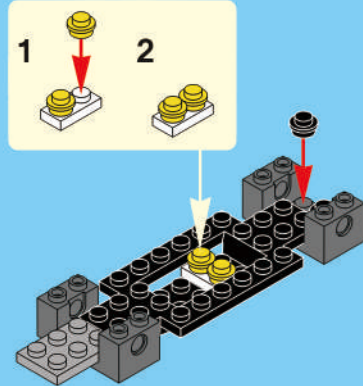

4

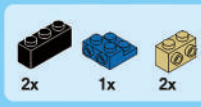
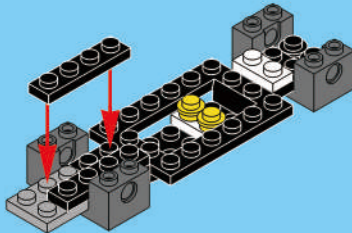

5

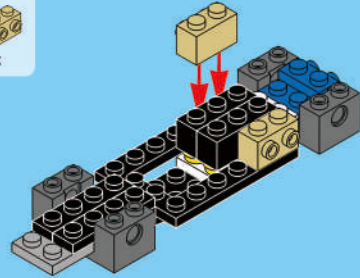

6

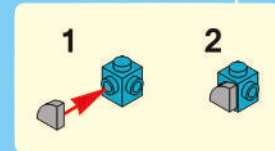
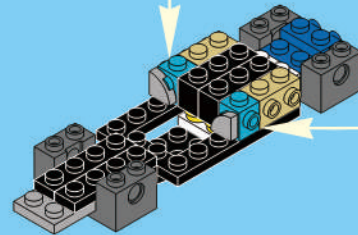
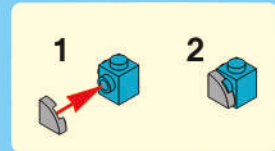



7

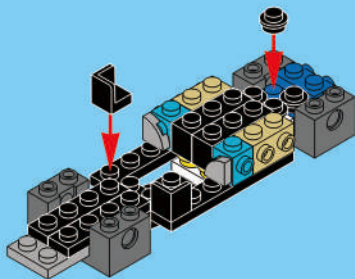

8

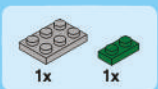
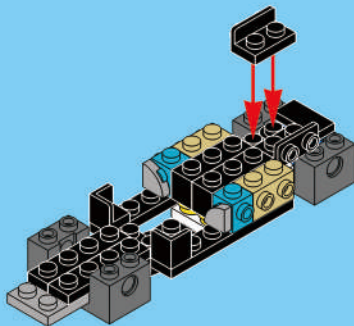

9

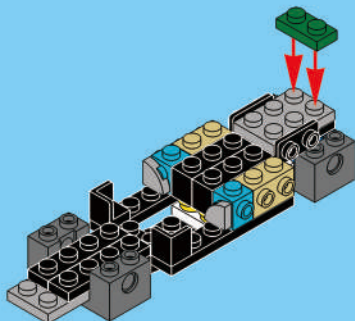

10

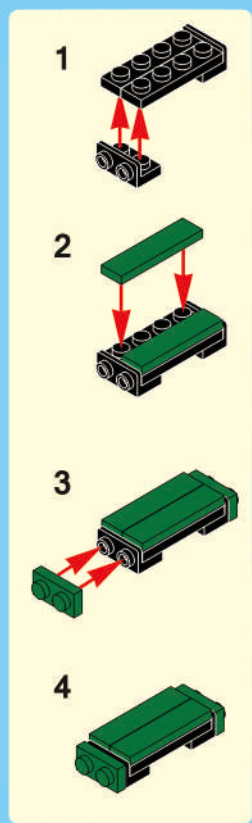
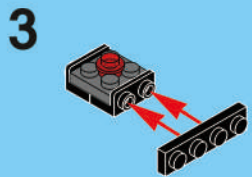
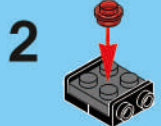
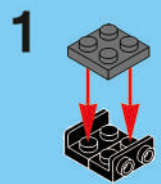

4

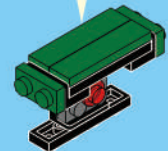

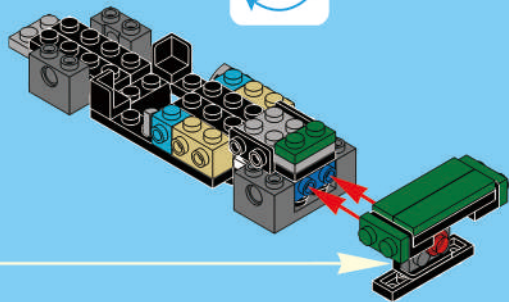

11

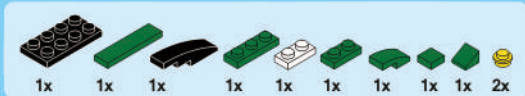
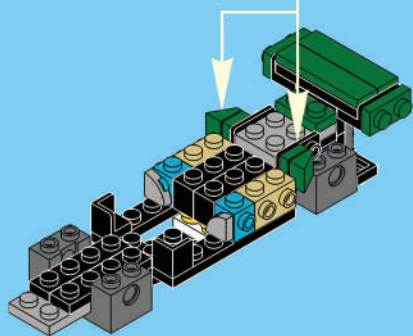
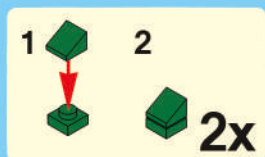

12

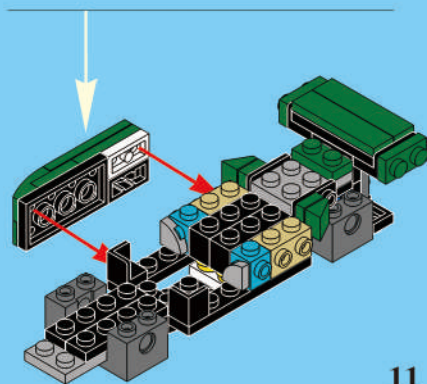
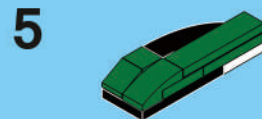
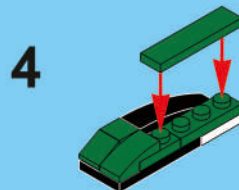
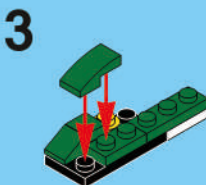
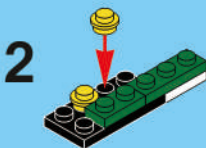
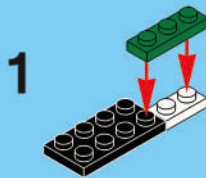

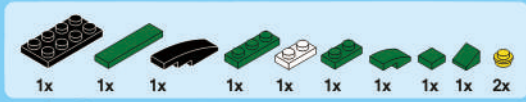

13

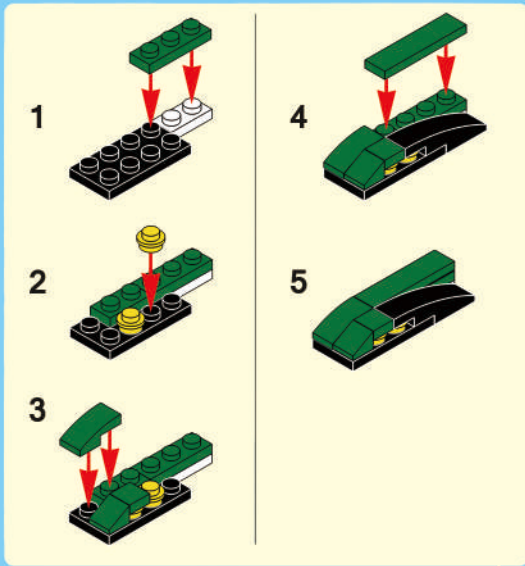

12

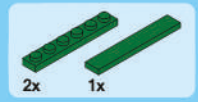
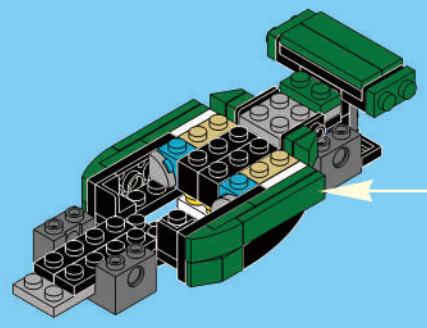

14

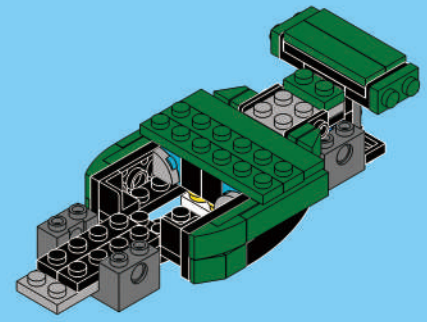

15

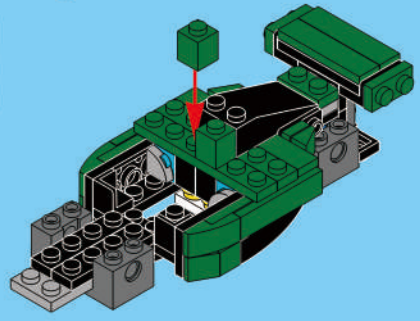

16

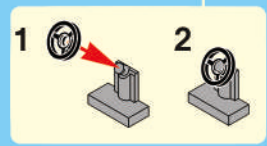
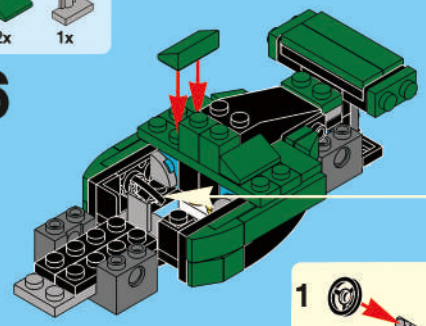

2x 1x 1x

17

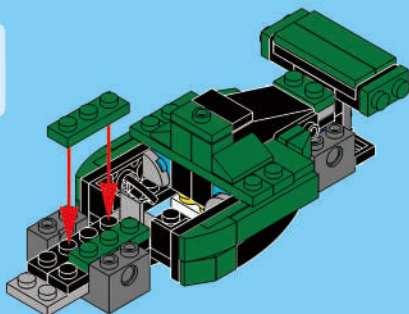

3x 1x

18

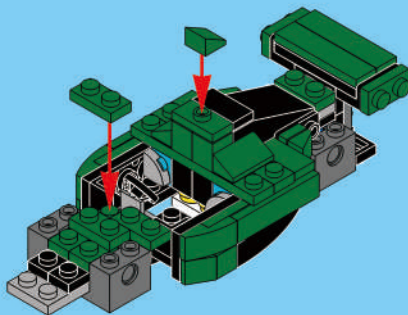

1x 1x 2x

19

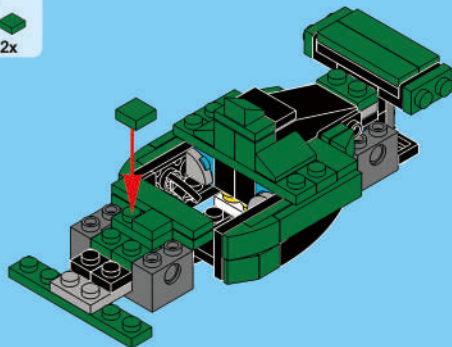

2x 1x

20

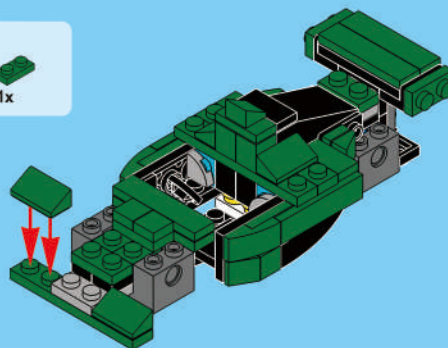

1x 1x 1x

21

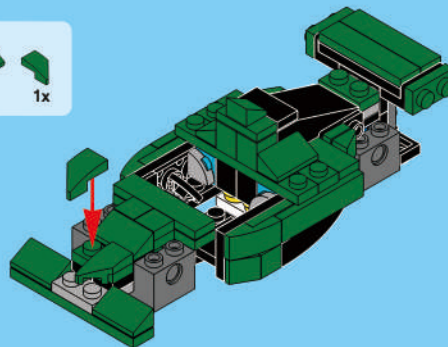

4x

22

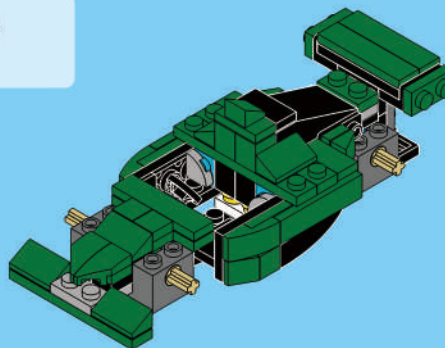



23

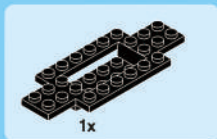
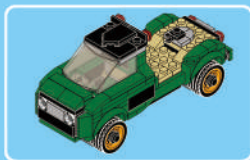
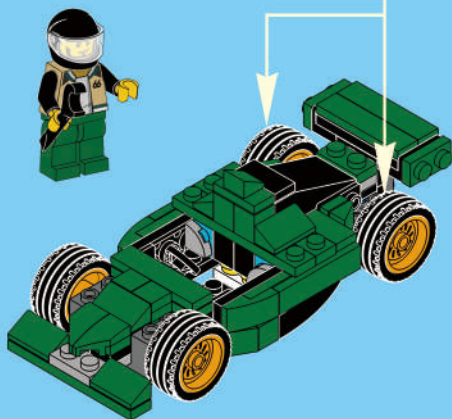
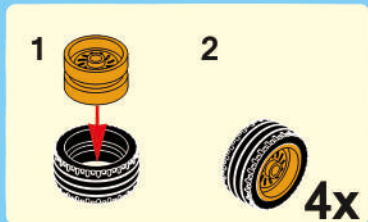

1

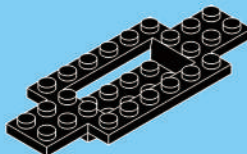

2

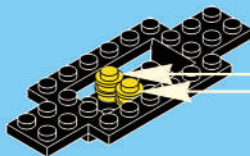
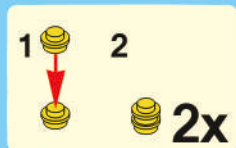



3

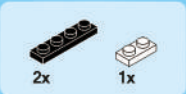
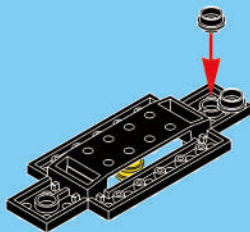

4

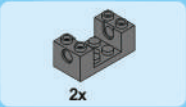
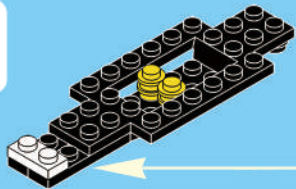
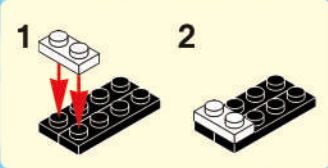

5

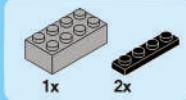
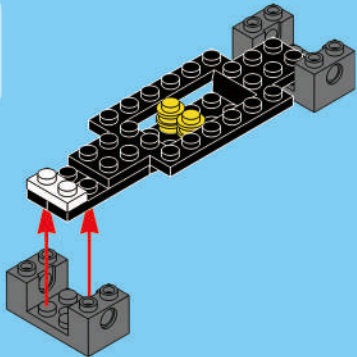

6

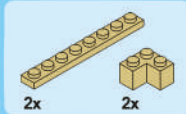
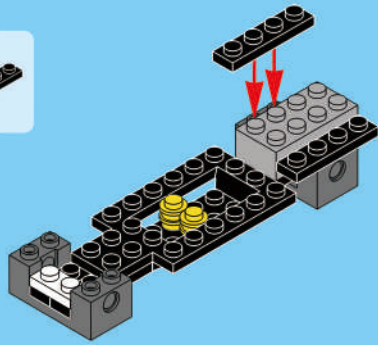

7

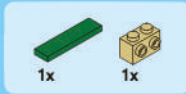
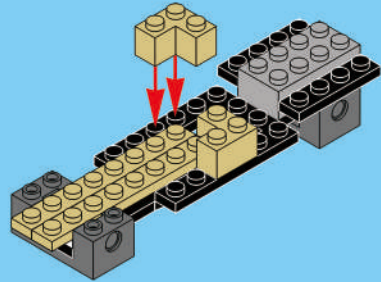

8

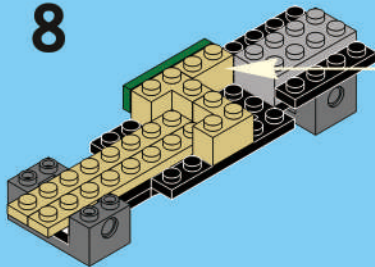
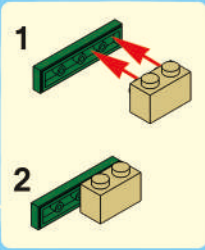



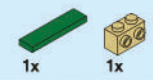

9

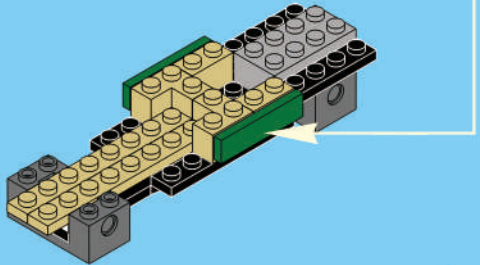
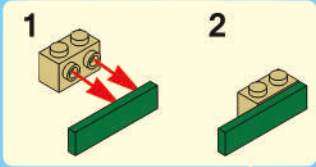

10

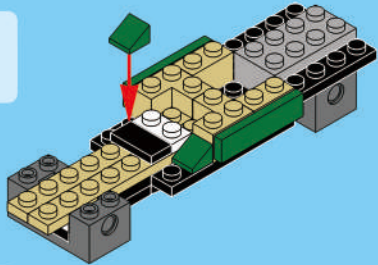

11

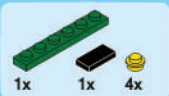
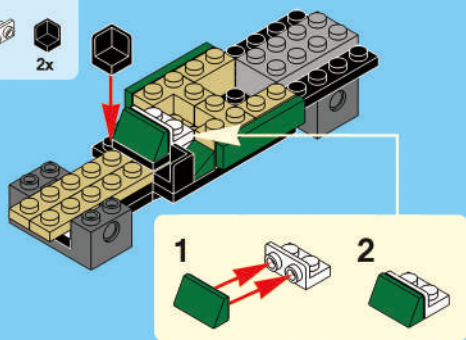

12

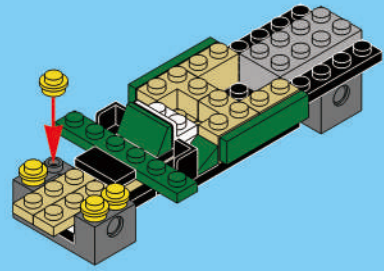

13

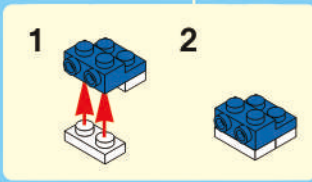
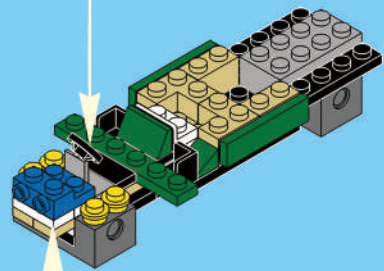
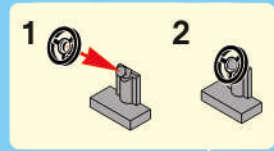



14

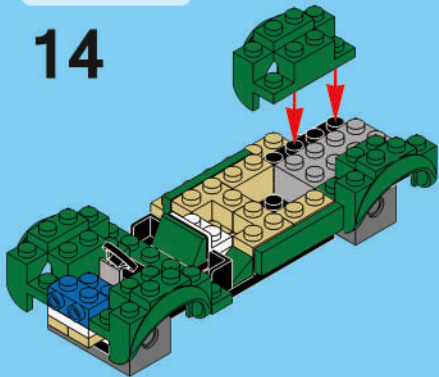

15

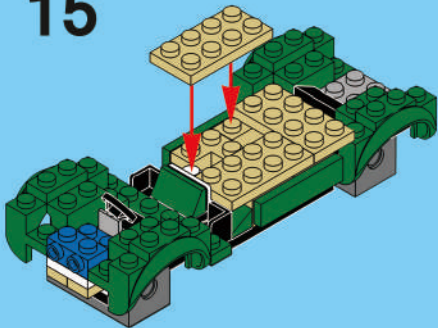

16

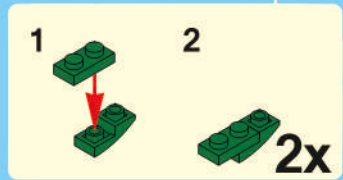
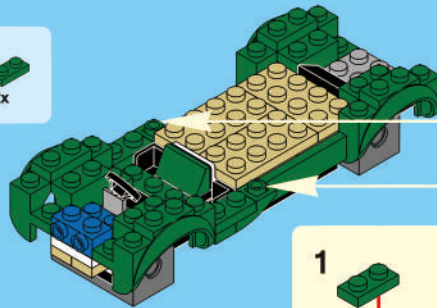

17

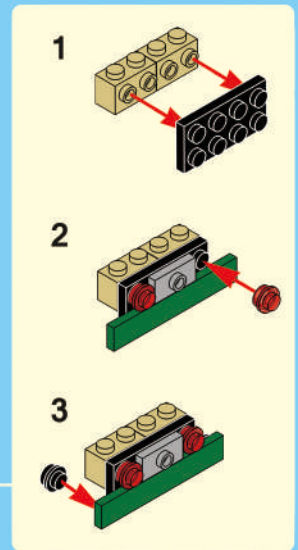
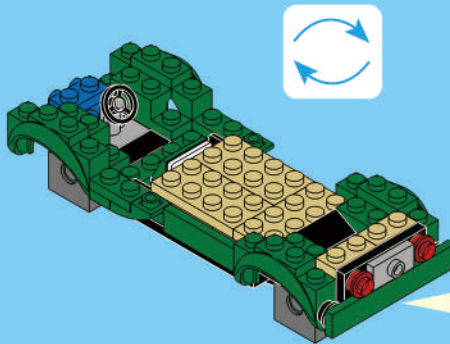

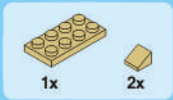

18

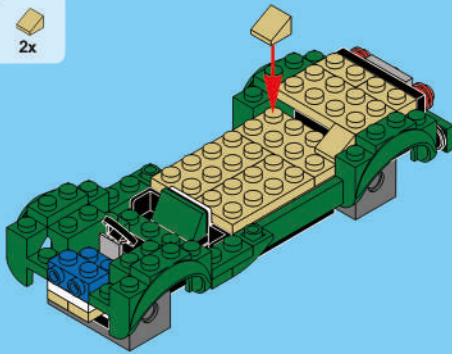

19

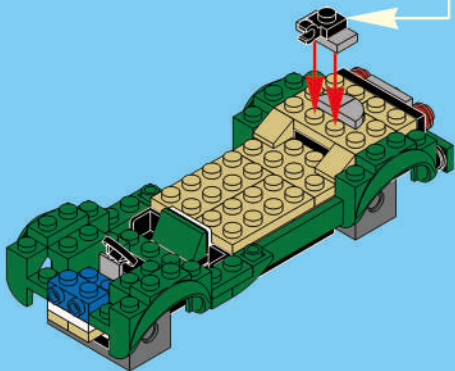
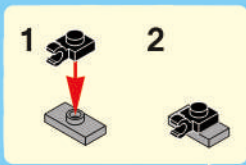

18

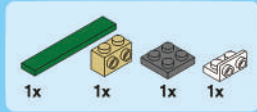

20

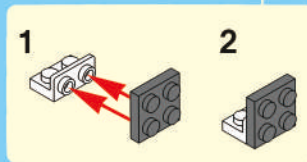
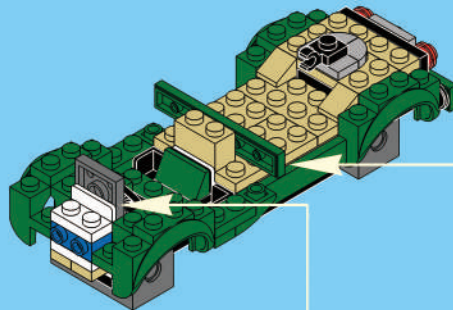
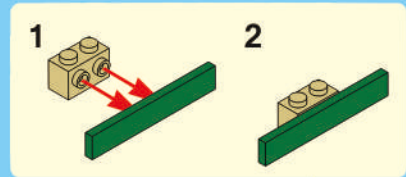

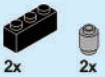

21

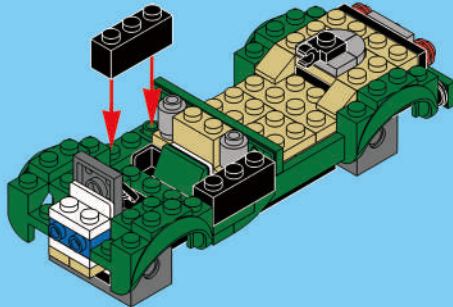

22

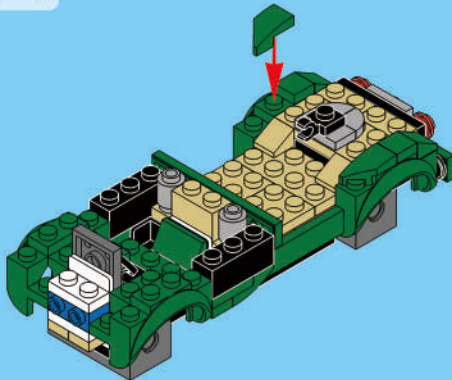

23

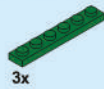
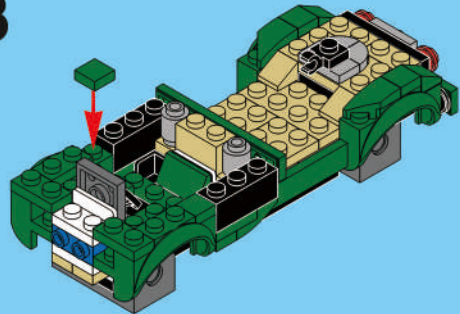

24

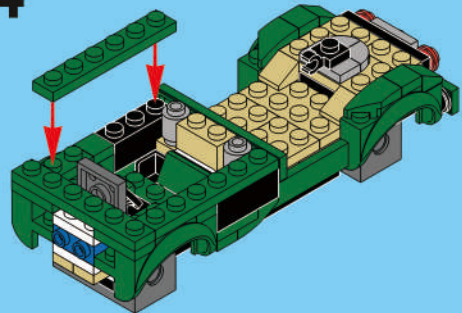

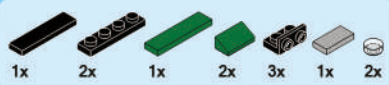

25

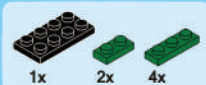
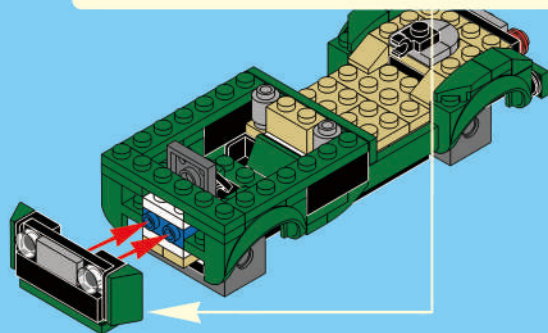
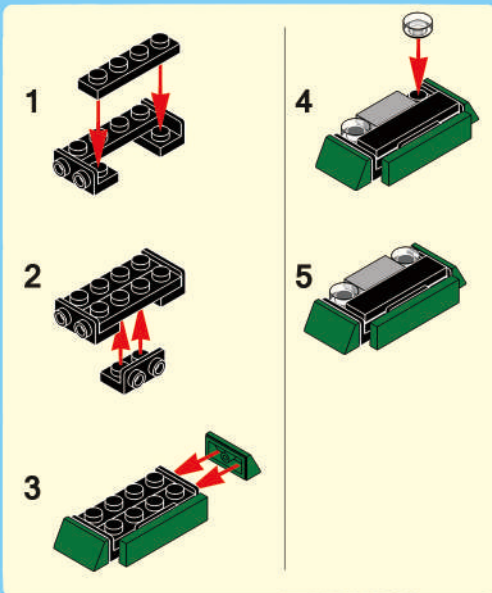

26

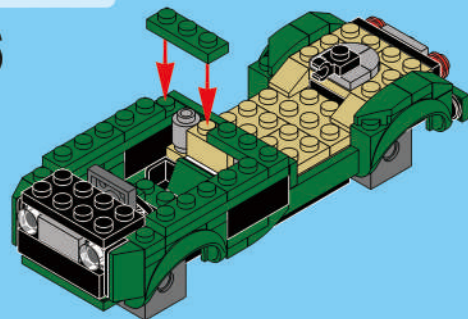

27

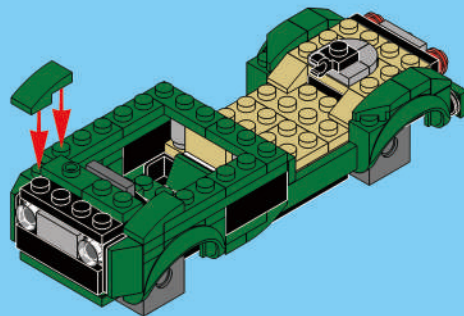



28

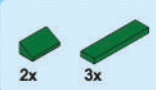
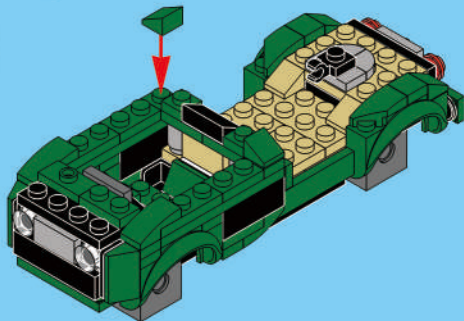

29

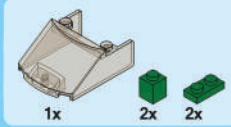
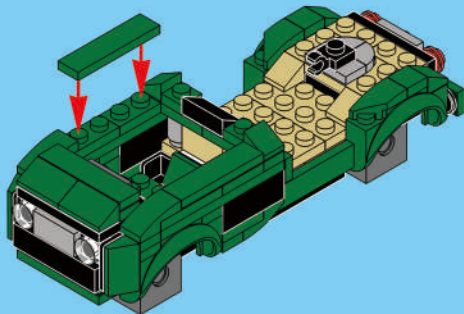

30

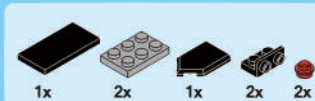
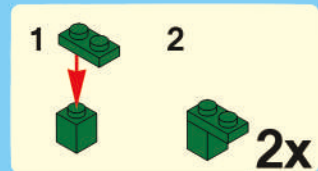
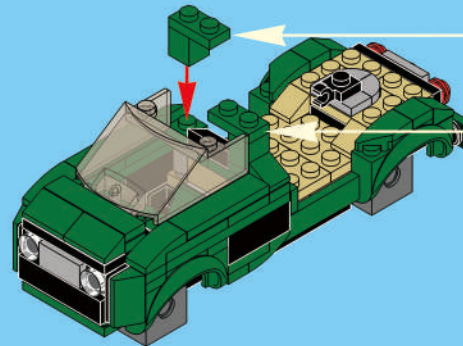

31

1

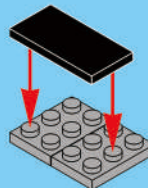

2

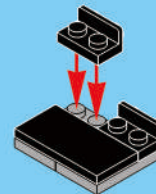

3

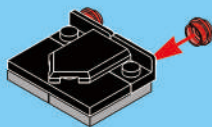

4

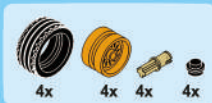
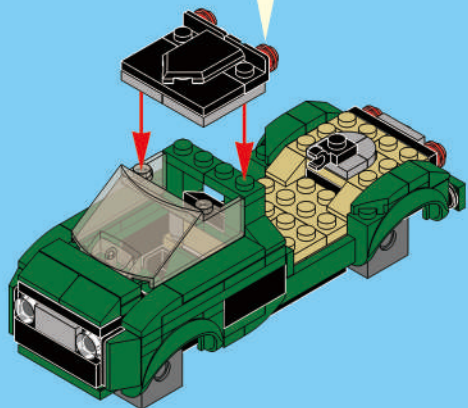
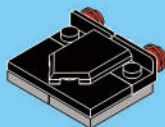

32

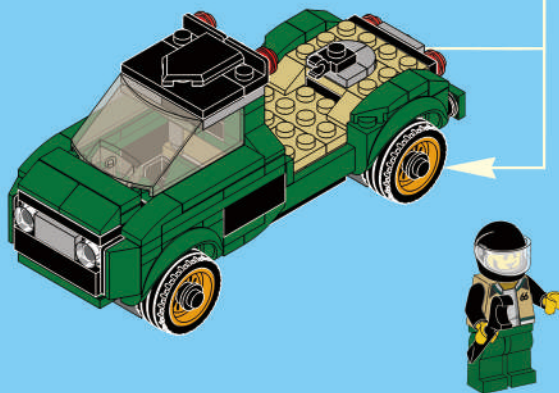
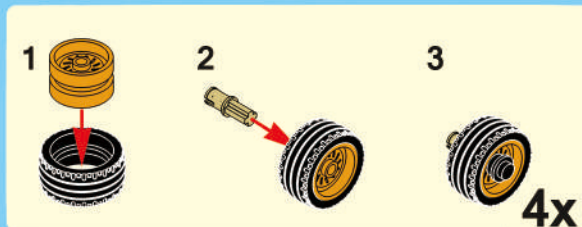

# ИНСТРУКЦИЯ MECHANICS



3

ВАРИАНТА  
СБОРКИ



7

ВАРИАНТОВ  
СБОРКИ

