

# 217

ДЕТАЛЕЙ

# 10

ВАРИАНТОВ  
СБОРКИ

# ИНСТРУКЦИЯ MECHANICS



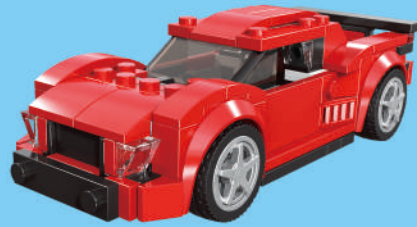

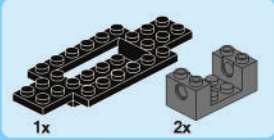
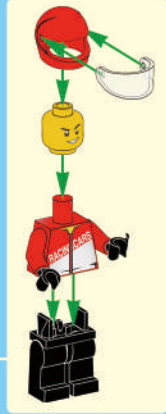

1

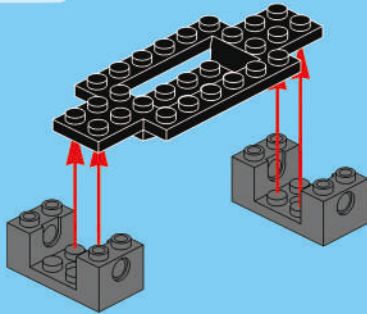

2

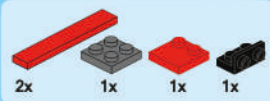
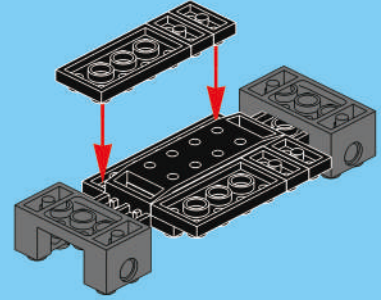

3

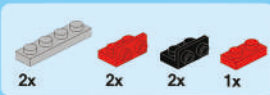
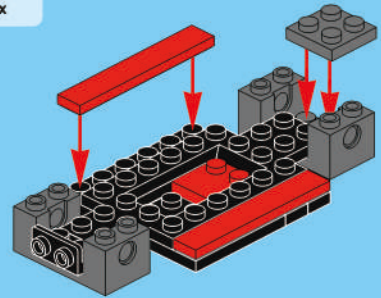

4

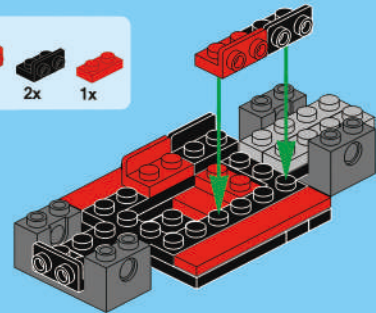

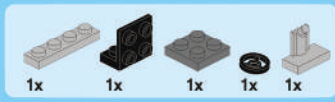

5

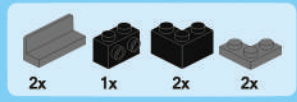
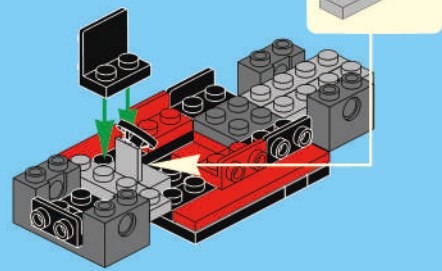

7

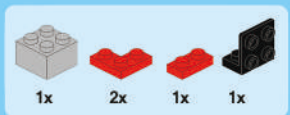
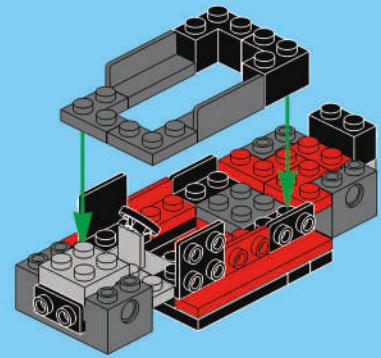

6

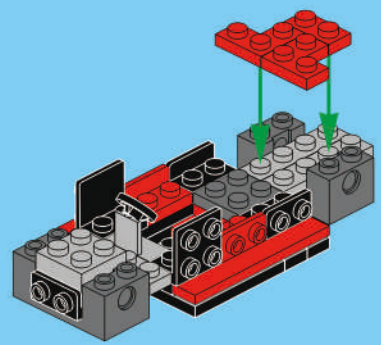

8

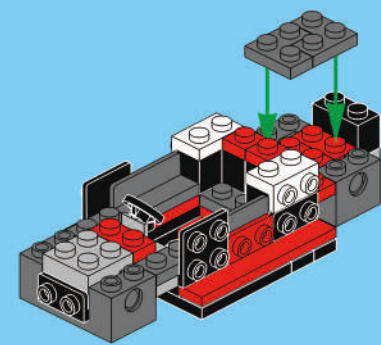

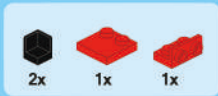

9

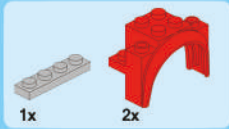
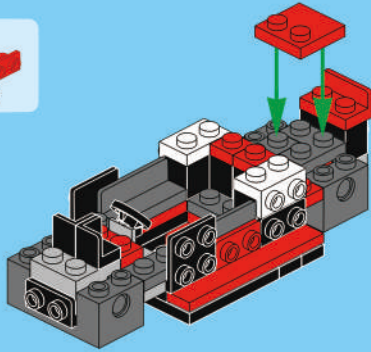

10

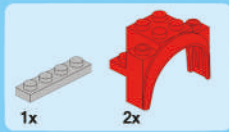
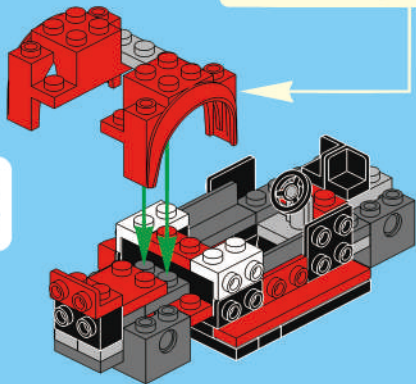
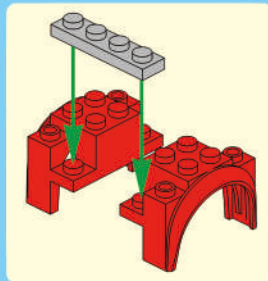

11

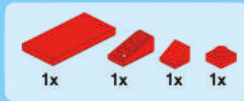
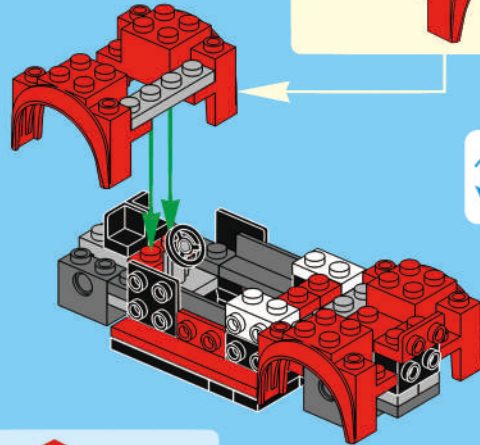
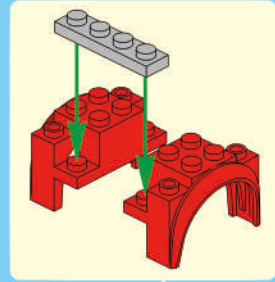

12

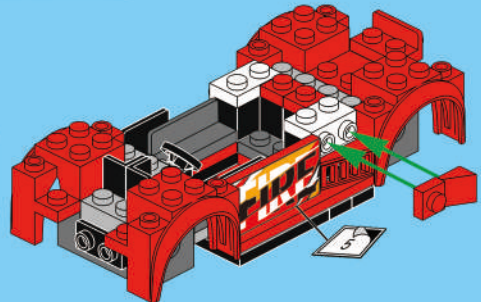

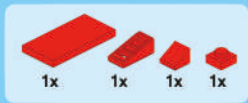

13

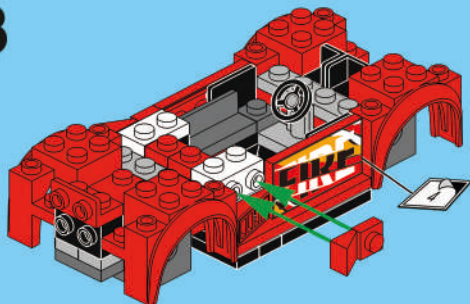

14

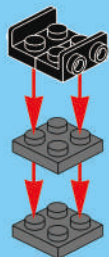

15

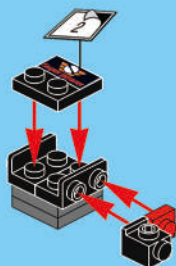

16

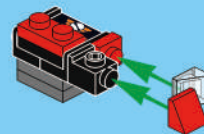

17

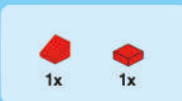
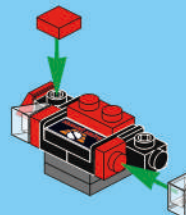

18

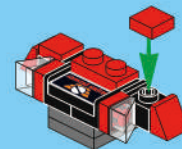



1x

19

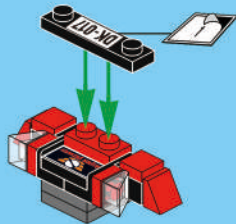

20

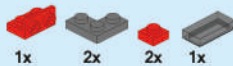
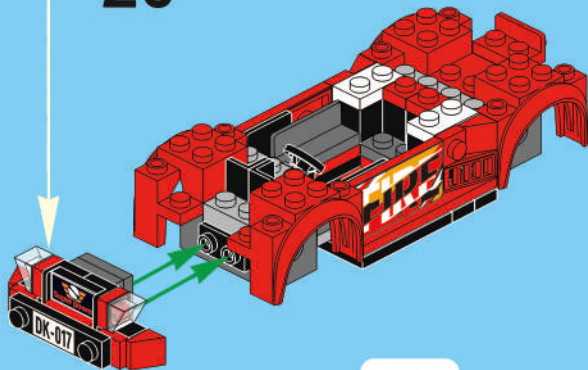

1x

2x

2x

1x

21

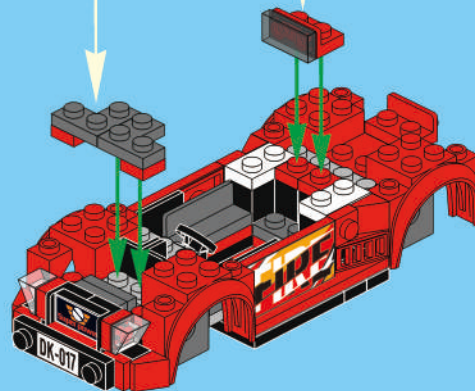
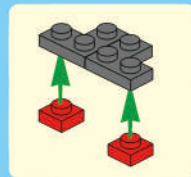
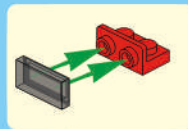



22

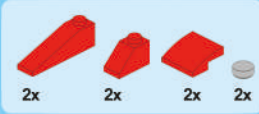
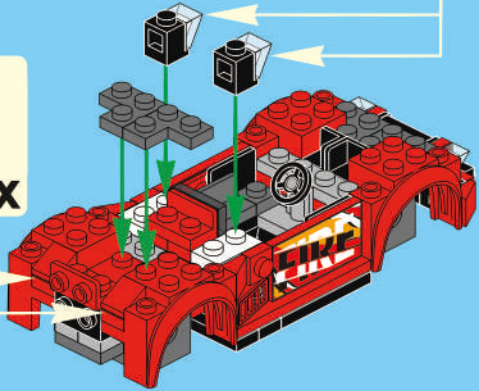
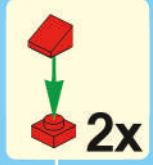

24

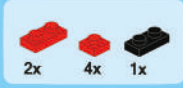
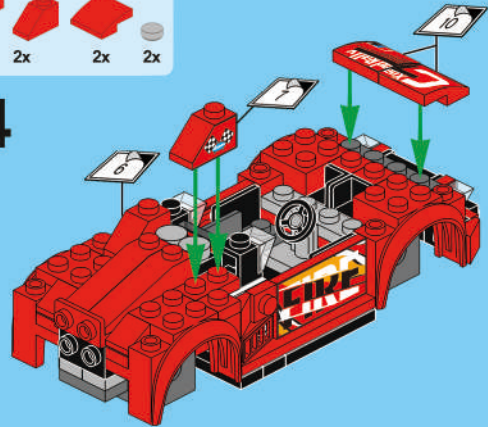

23

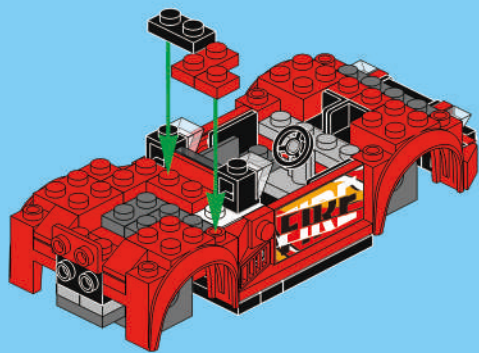

25

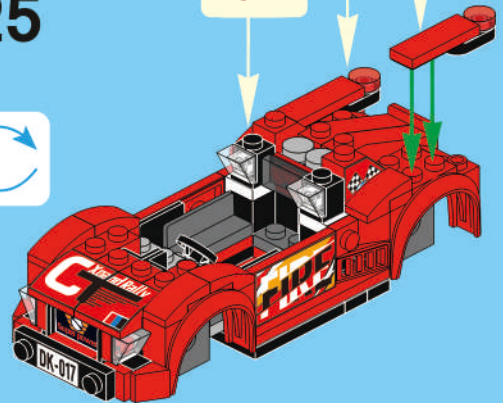
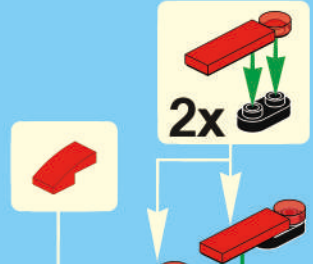



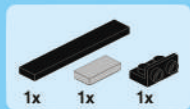

26

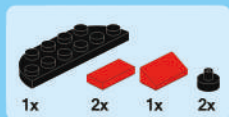
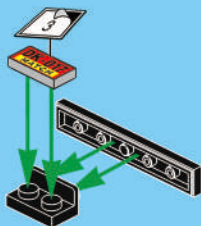

27

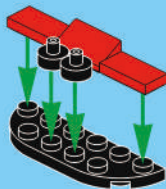

28

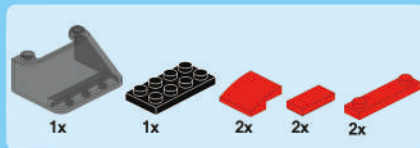
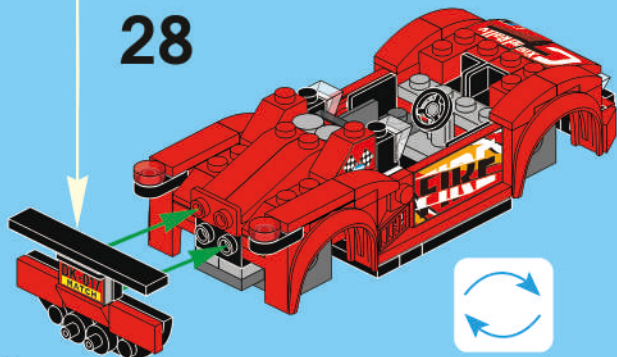

29

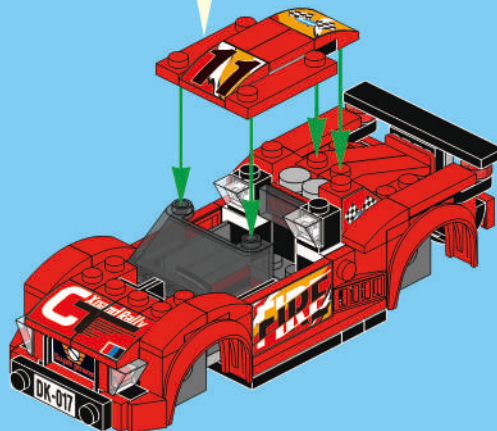
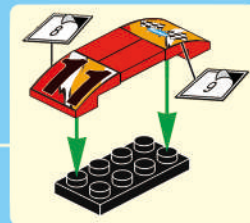



30

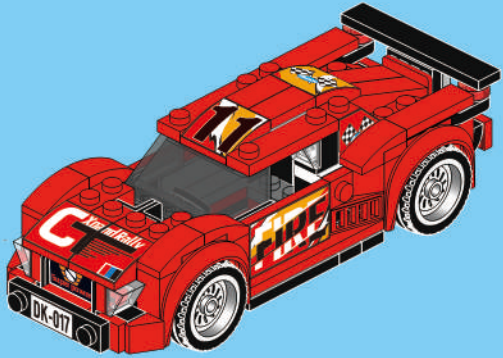
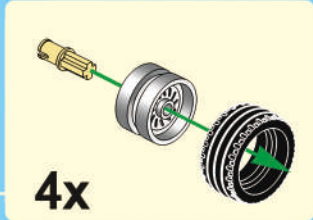
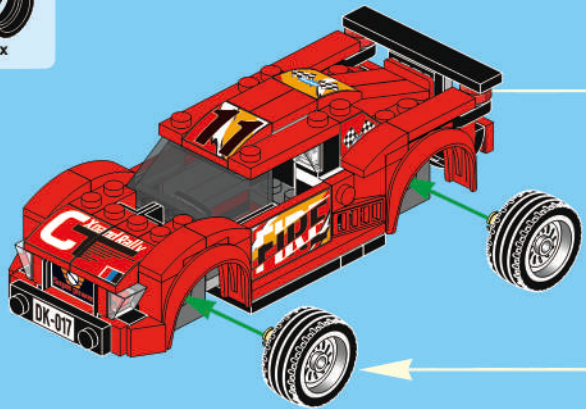

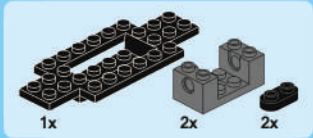
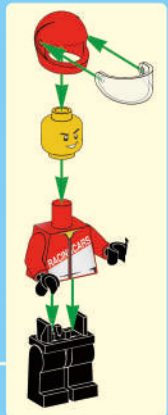
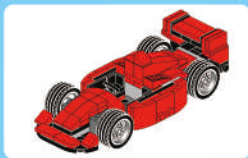

1

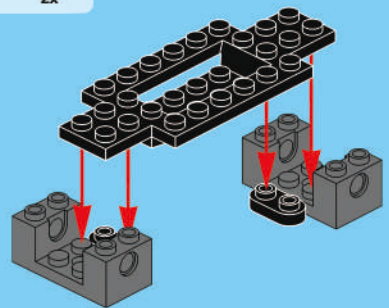

2

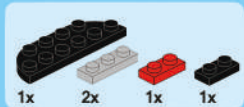
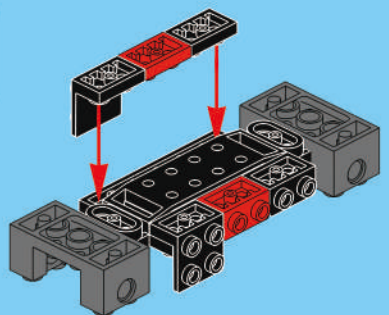

3

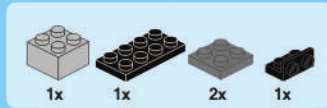
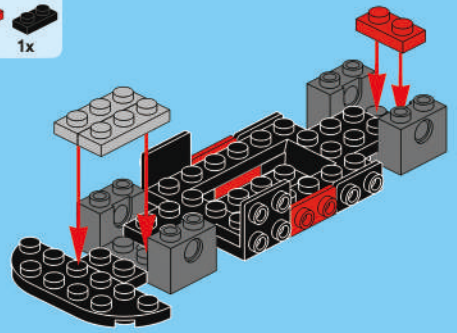

4

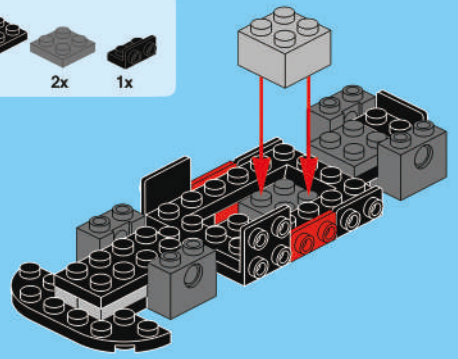



5

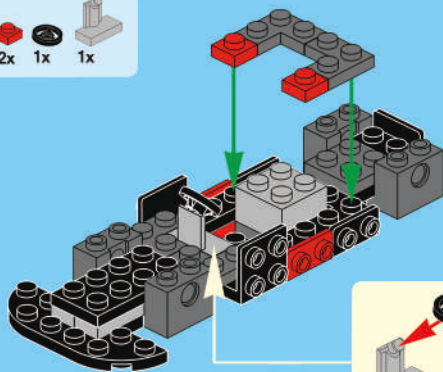

6

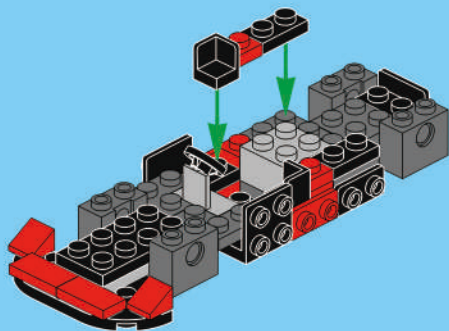

7

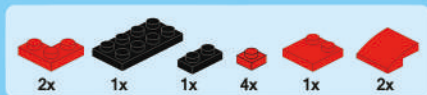
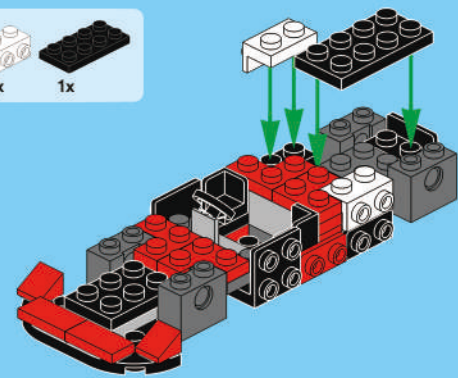

8

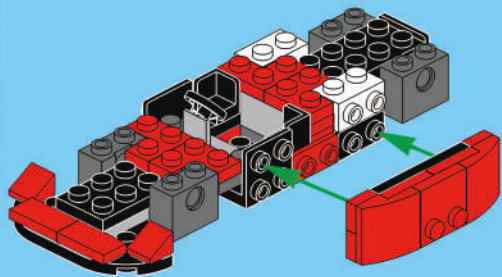
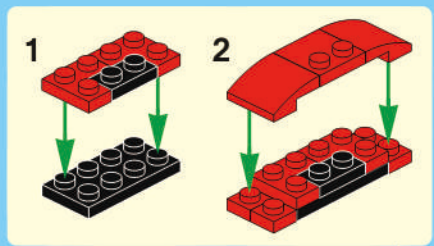

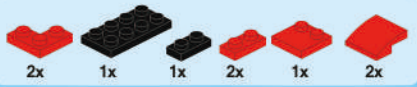

9

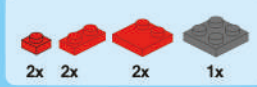
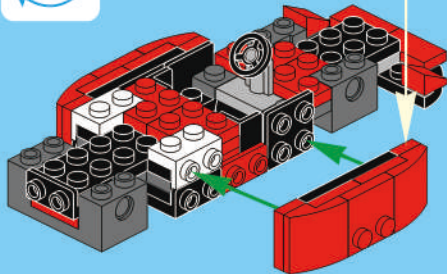
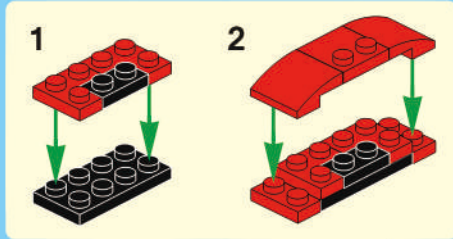

10

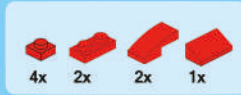
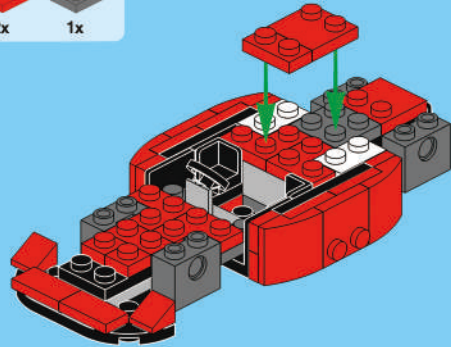

11

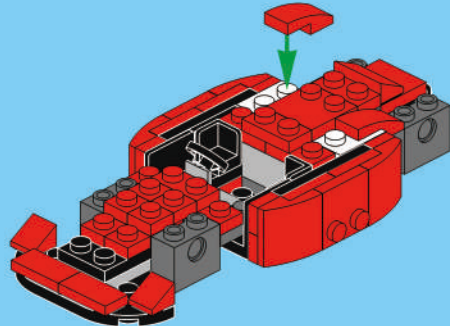

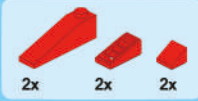

12

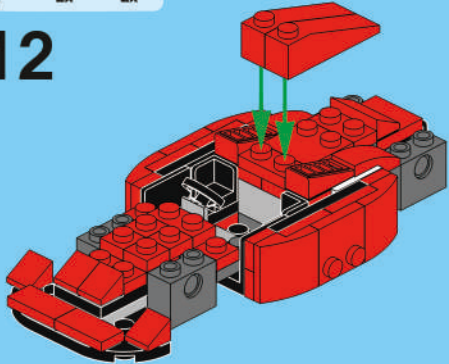

13

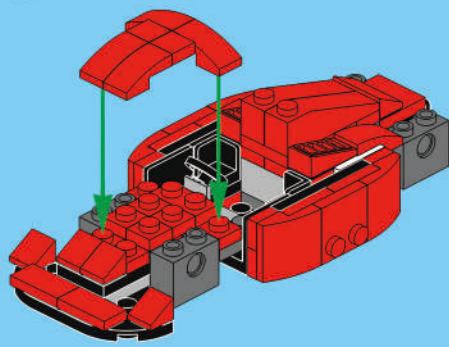

14

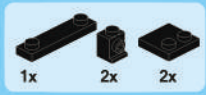
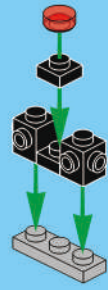

15

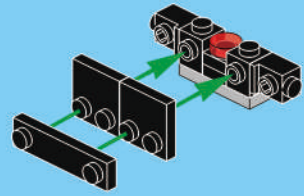

16

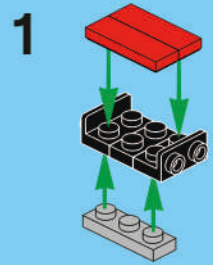

2

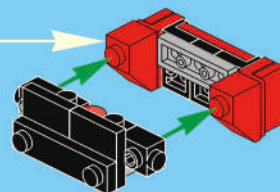
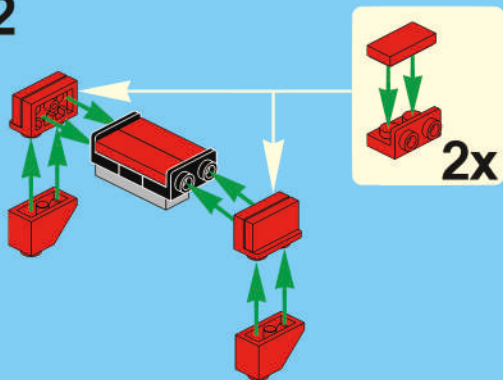

17

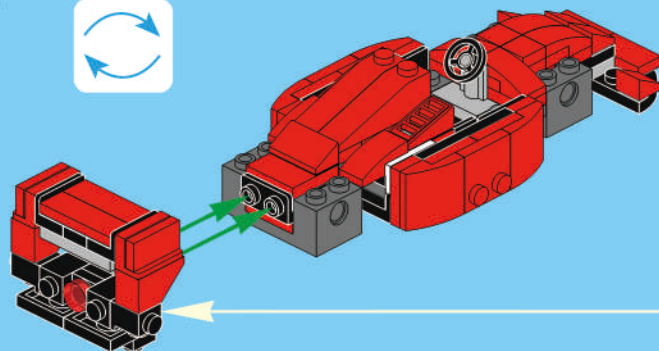



18

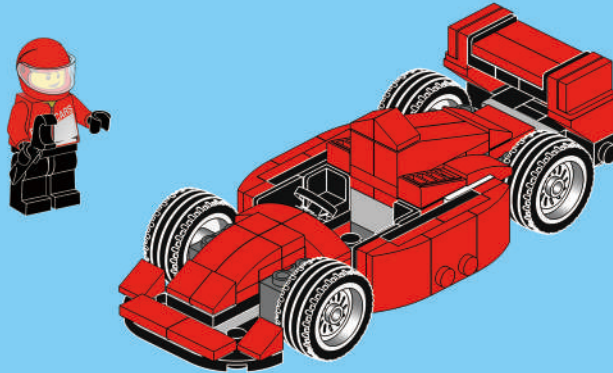
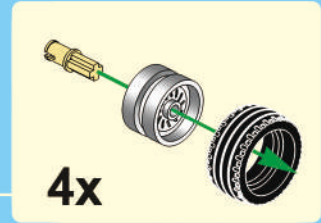
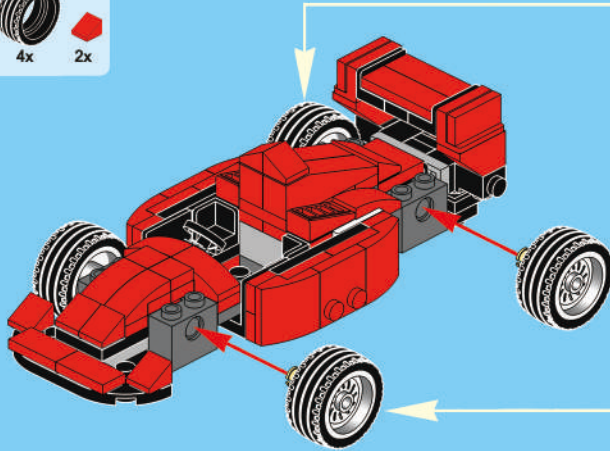



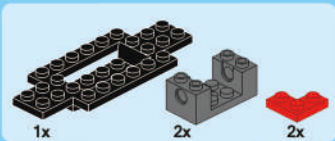
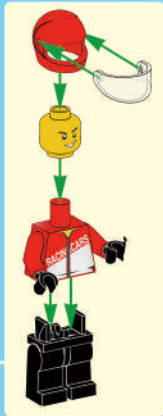
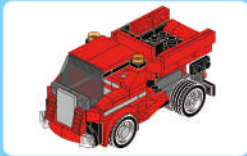

1

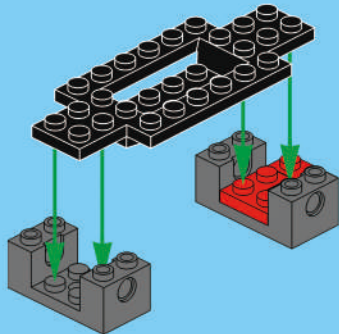

2

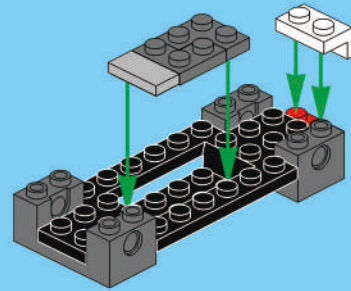

3

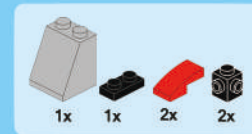
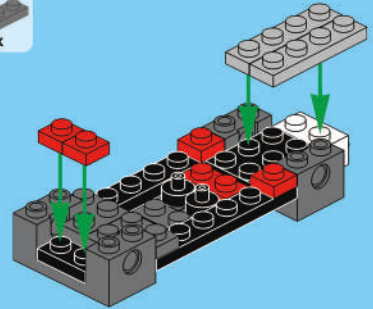

4

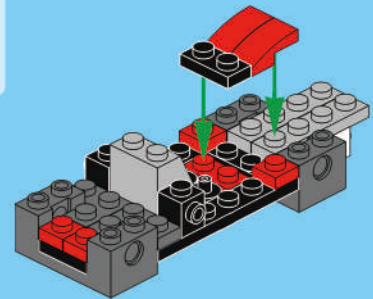

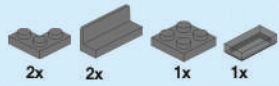

5

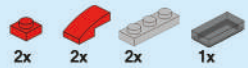
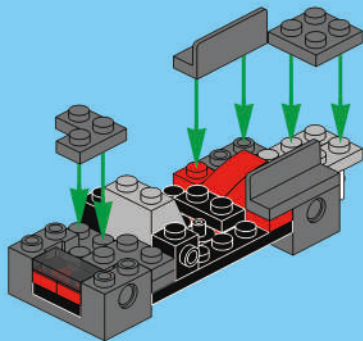

6

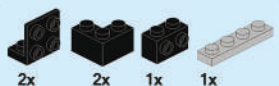
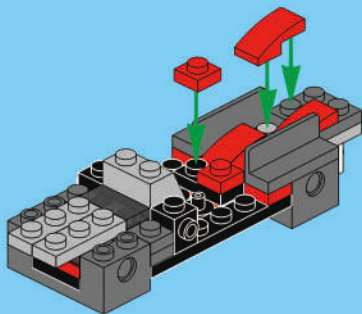

7

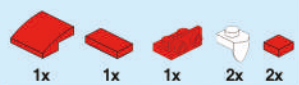
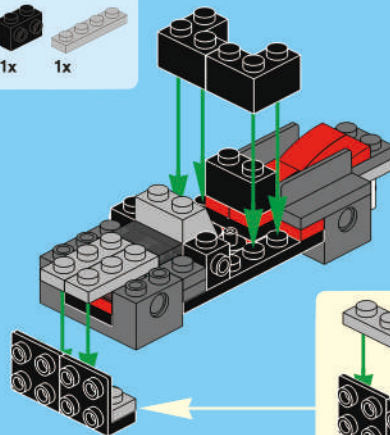

8

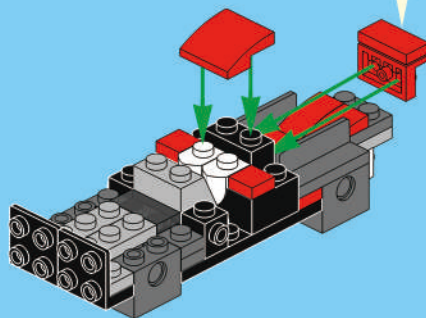

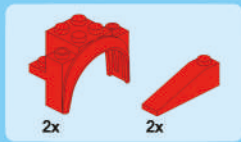

9

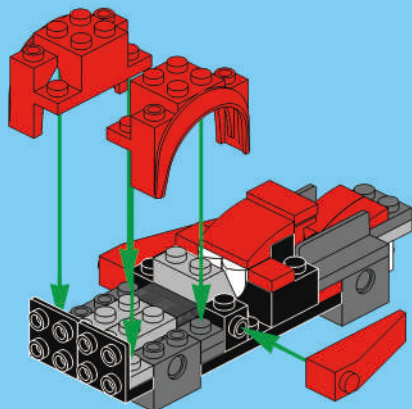

10

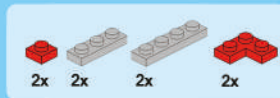
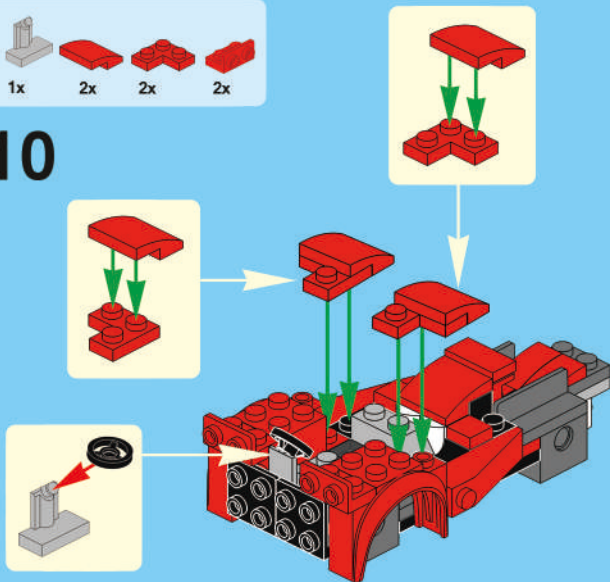

11

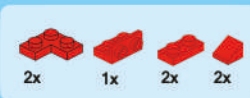
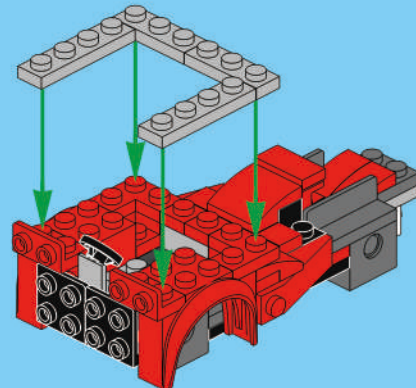

12

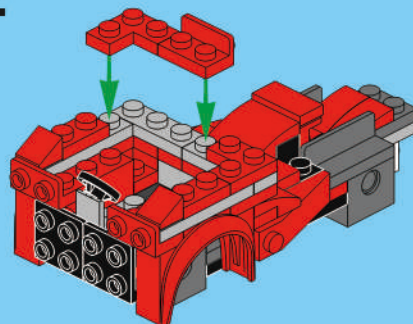

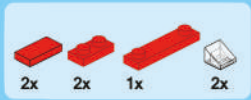

13

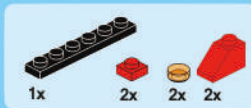
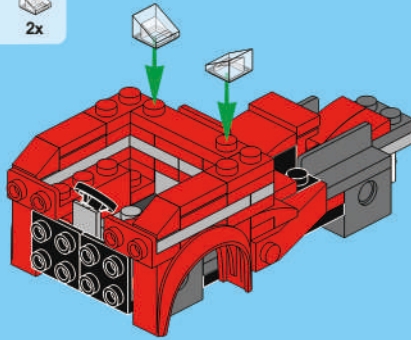

14

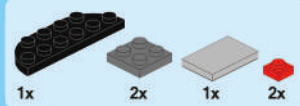
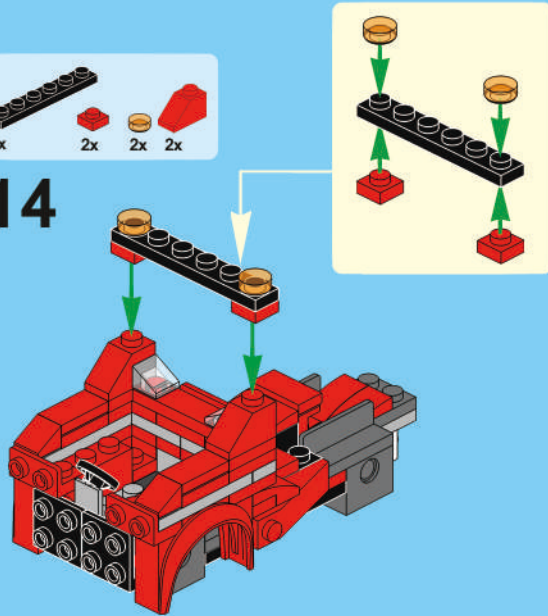

15

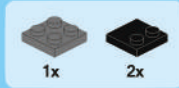
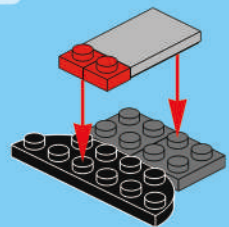

16

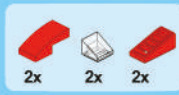
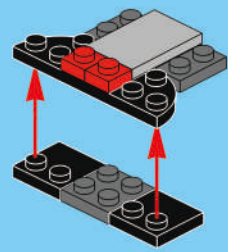

17

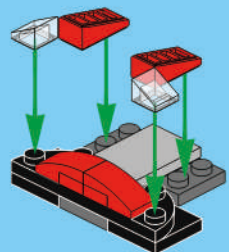

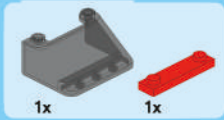

18

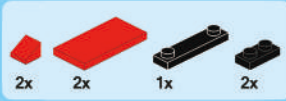
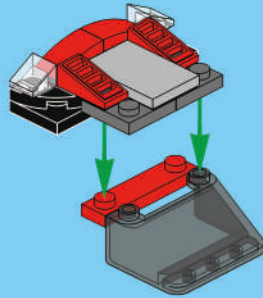

20

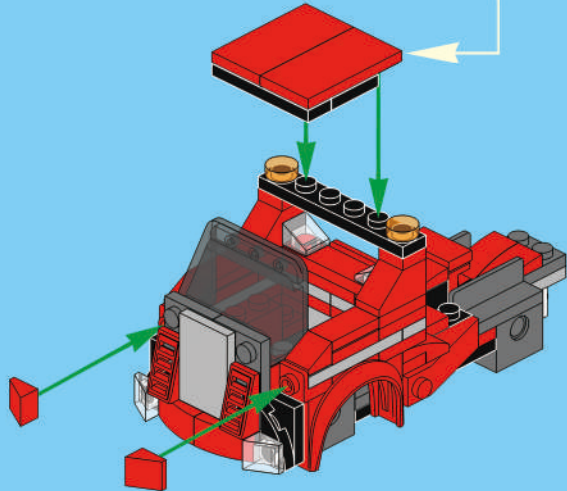
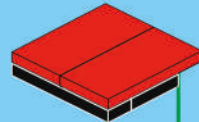
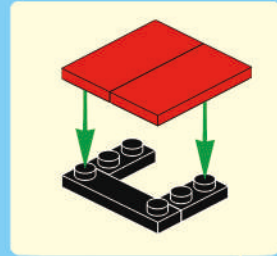

19

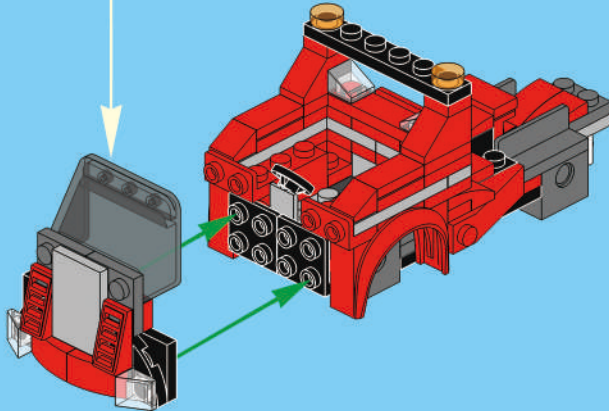

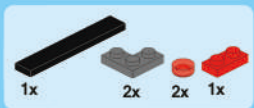

21

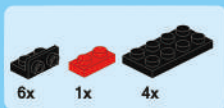
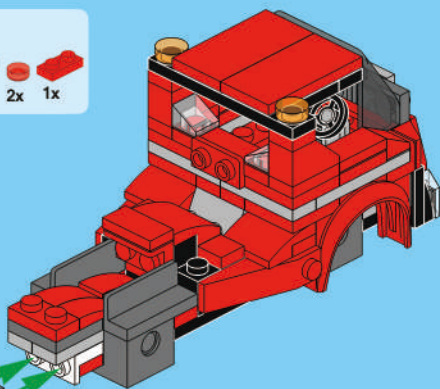
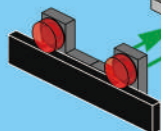

22

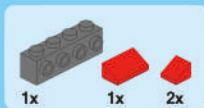
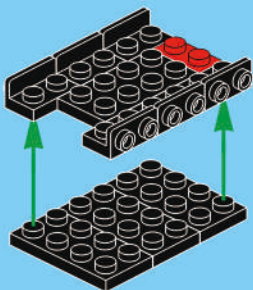

23

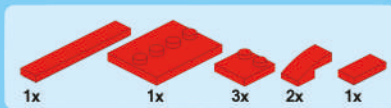
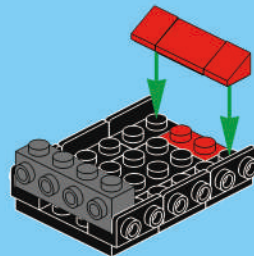

24

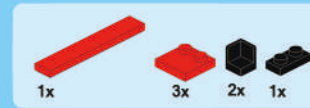
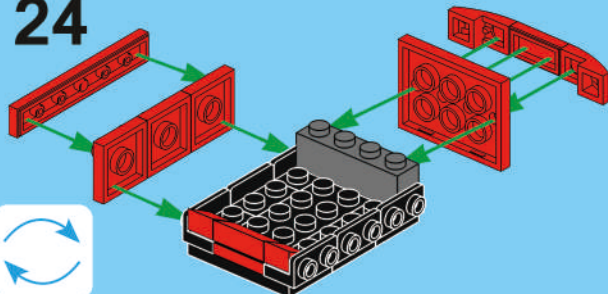

25

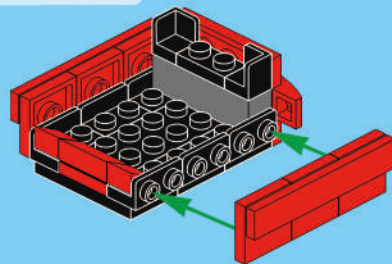



26

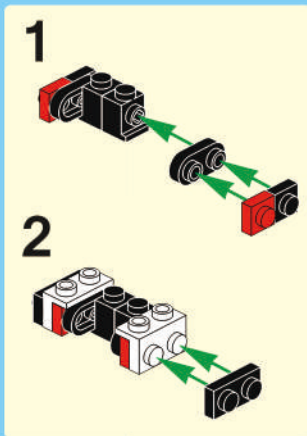
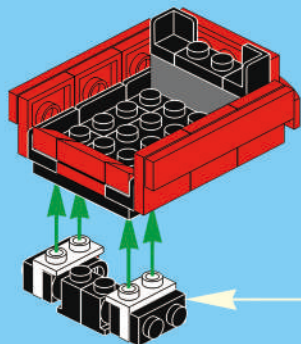

27

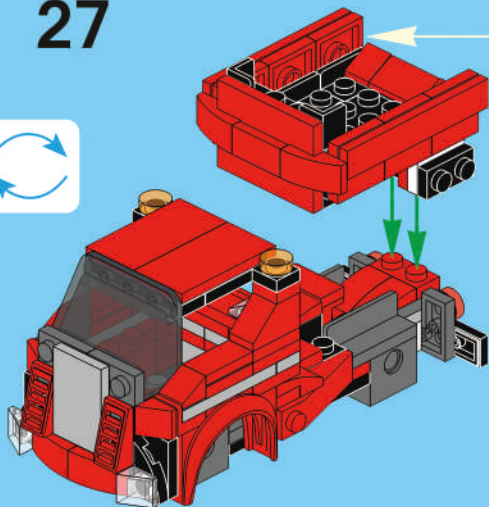

28

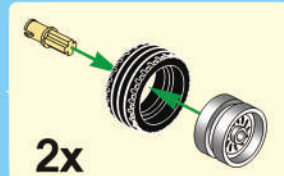
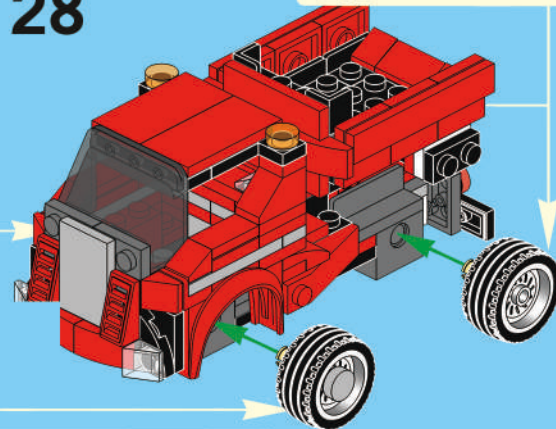

2x

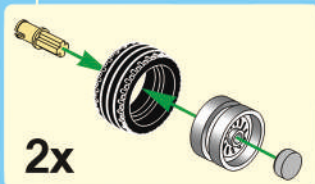

2x

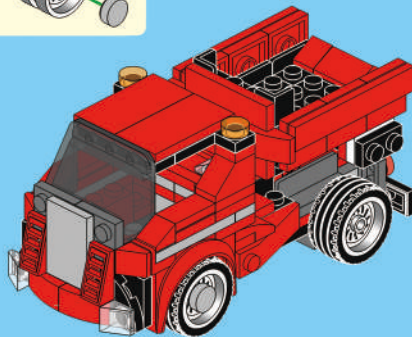

# ИНСТРУКЦИЯ MECHANICS

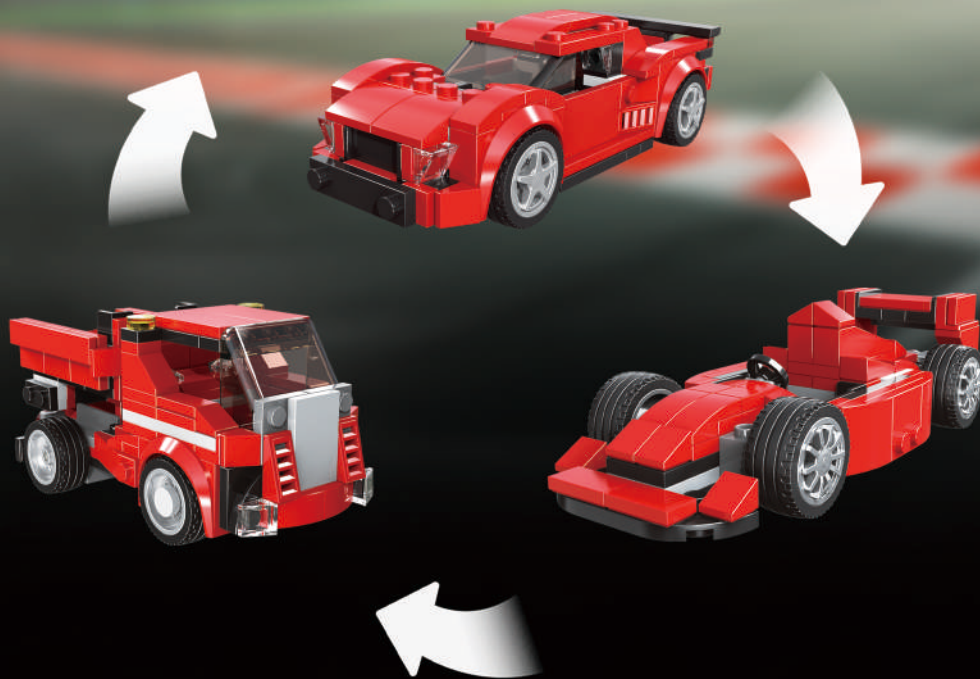

**3**

**ВАРИАНТА  
СБОРКИ**

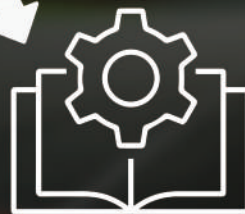

**7**

**ВАРИАНТОВ  
СБОРКИ**

