

KING STEERER

B RICKS

Pullback Action
Illustration



3413
BLACK CHAMPION RACER



3412
DAZZLING RED RACING CAR



3411
OFF-ROADER RACER



3414
DESERT RACER



TELEPHONE BOX



OFF-ROADER
RACER

3411



KING-STEERER

CAR

A PERFECT COMBINATION OF
INTELLIGENCE AND TECHNOLOGY!

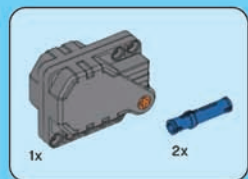
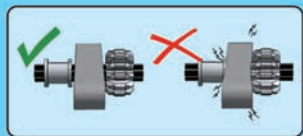

1

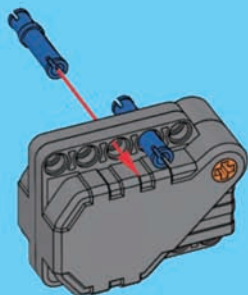

2

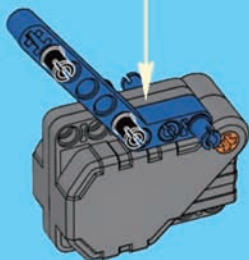
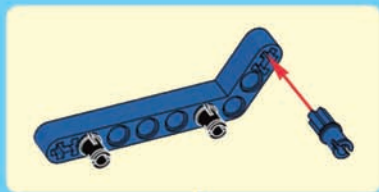

2

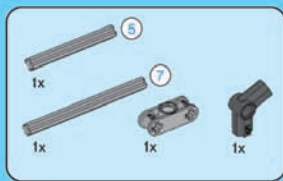

3

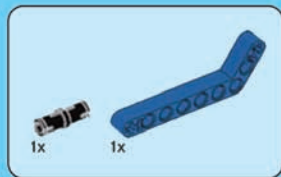
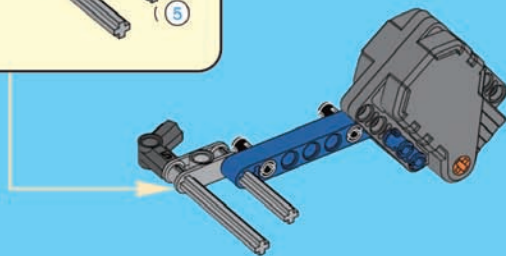
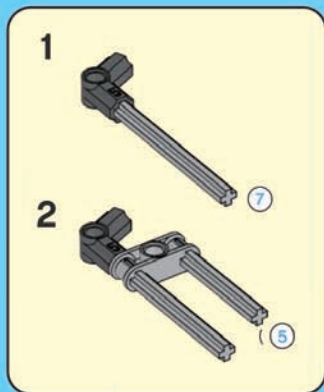

4

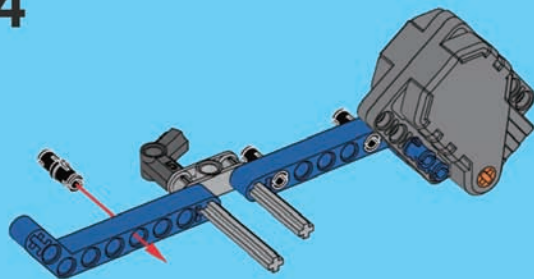



1



2

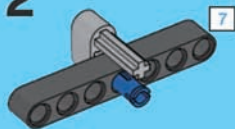

3

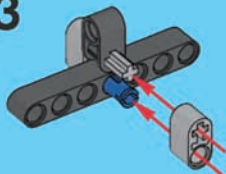

4

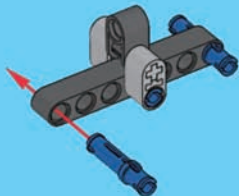

5

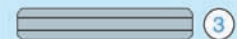
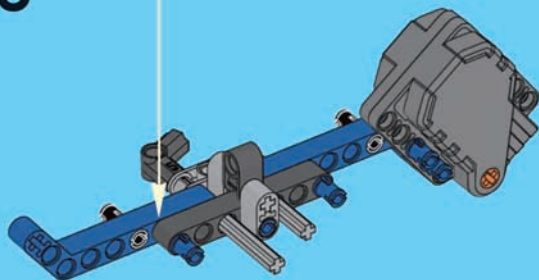

1:1

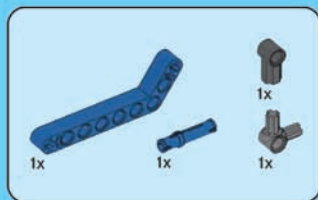

6

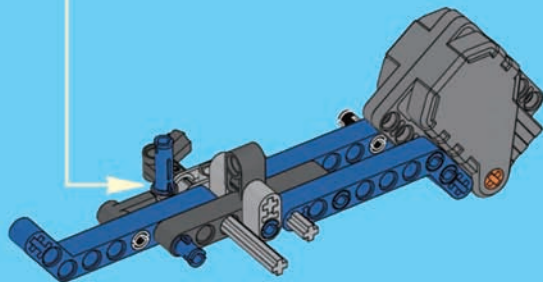
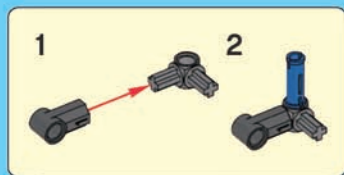

7

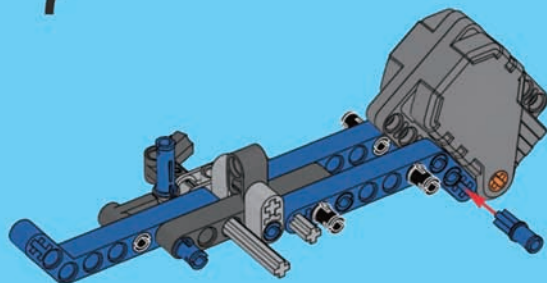

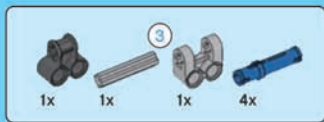

8

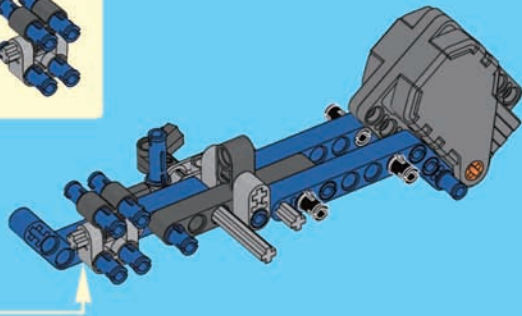
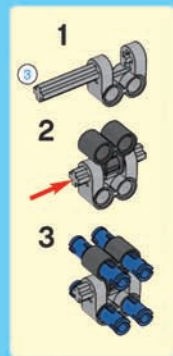

6

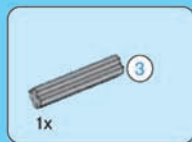

9

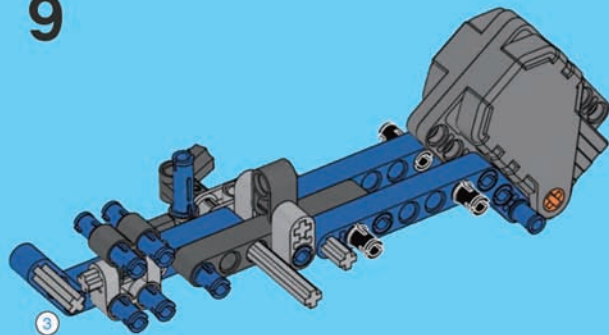

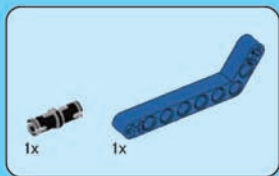

10

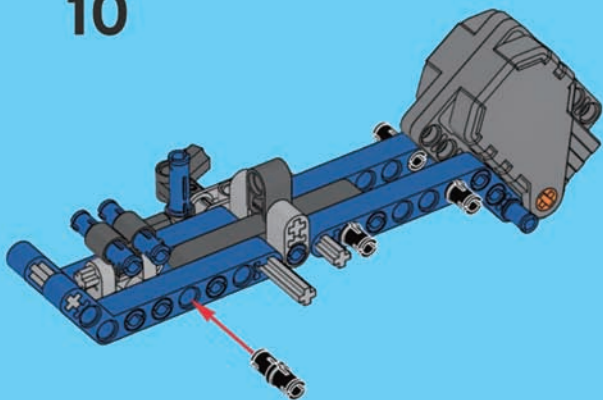

11

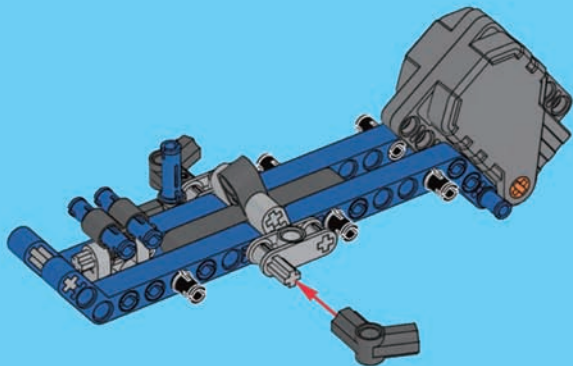



12

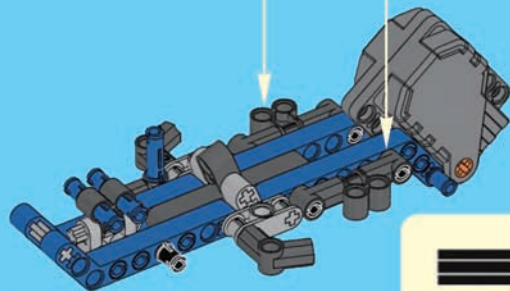
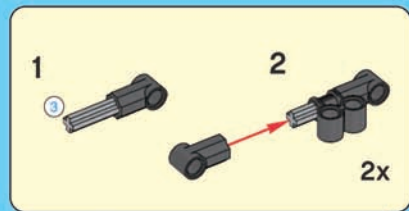

13

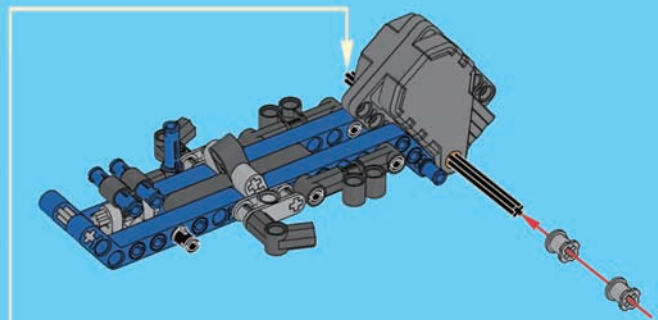



14

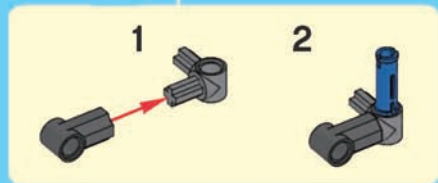
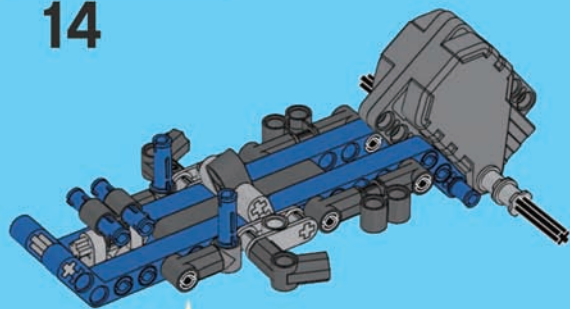

15

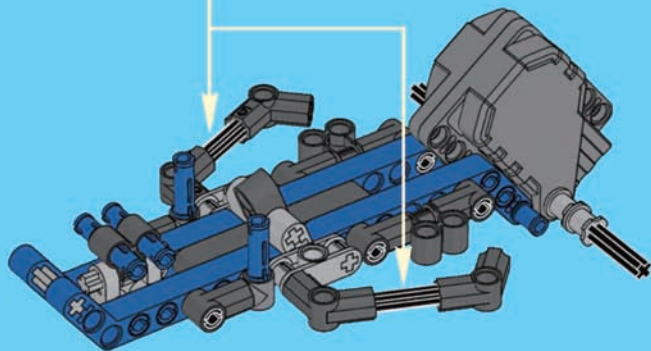
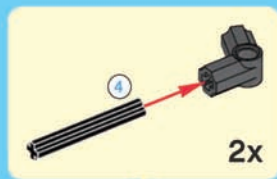



16

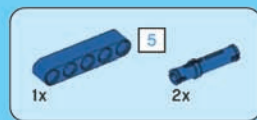
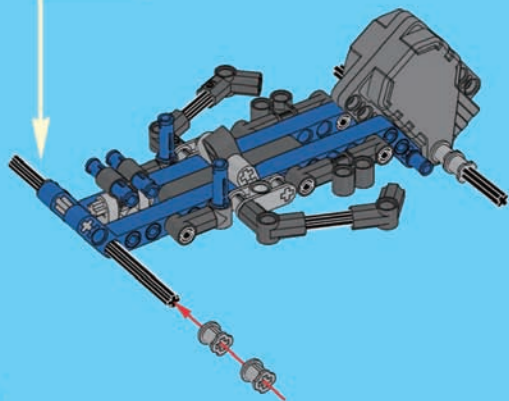

17

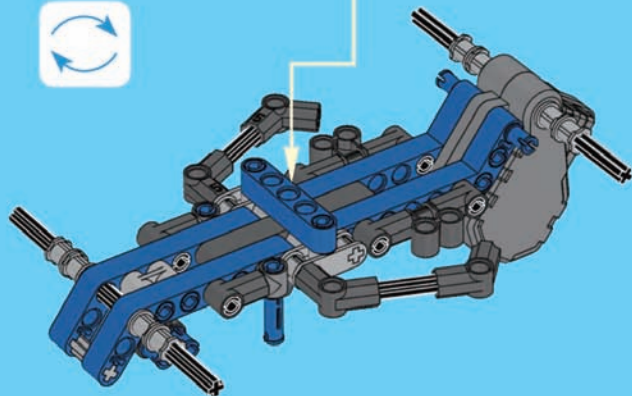
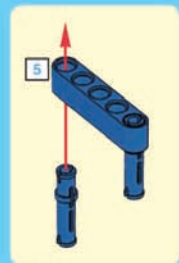

1:1

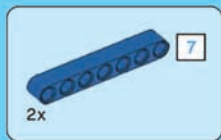

18

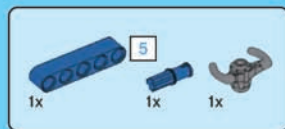
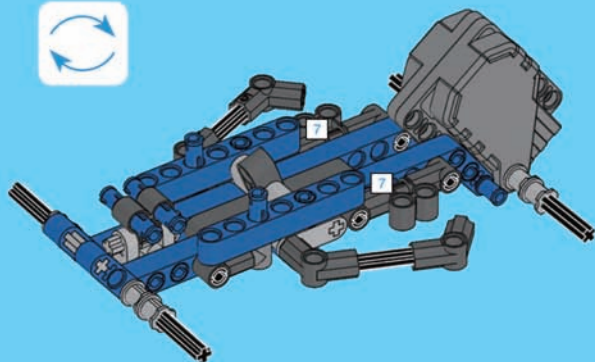

19

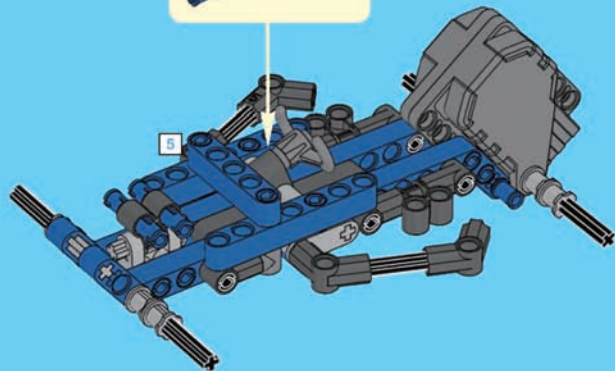

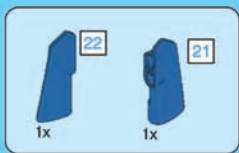

20

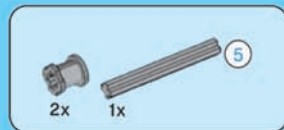
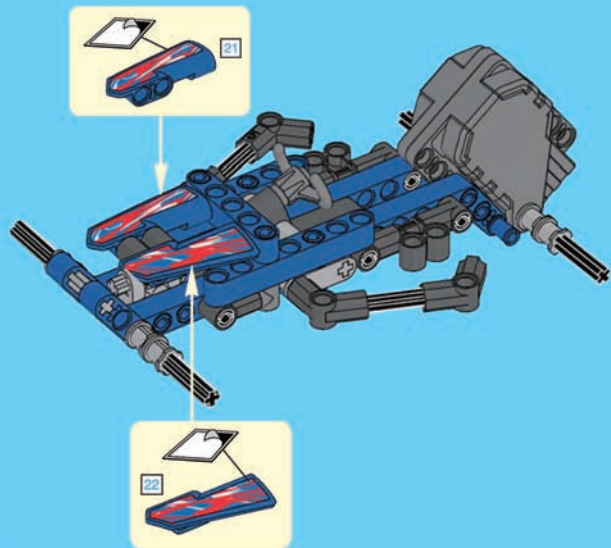

21

5 1:1

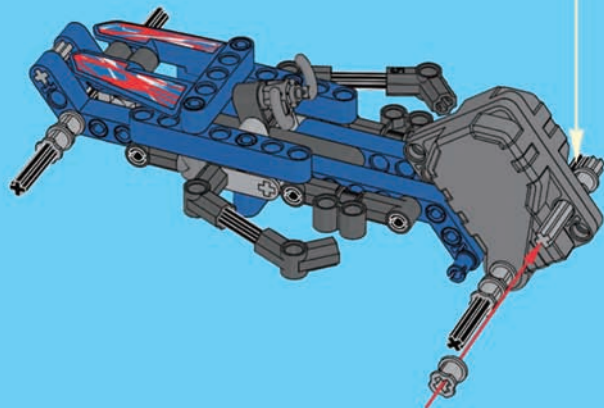

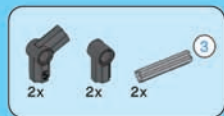

22

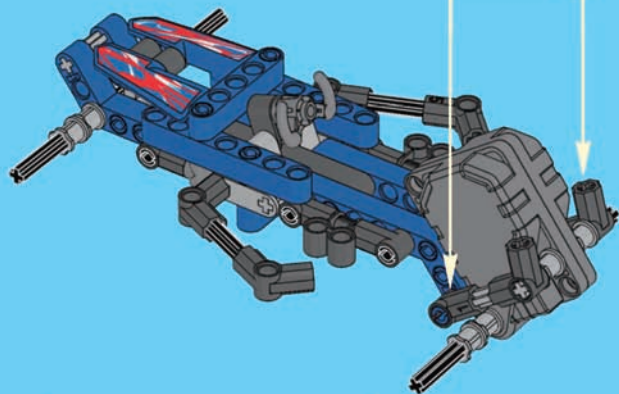

1

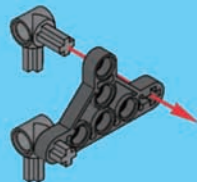

2

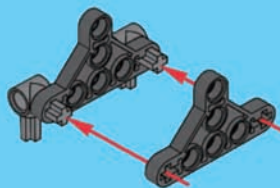



3

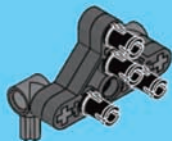

4

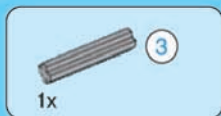
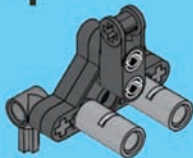

5



23

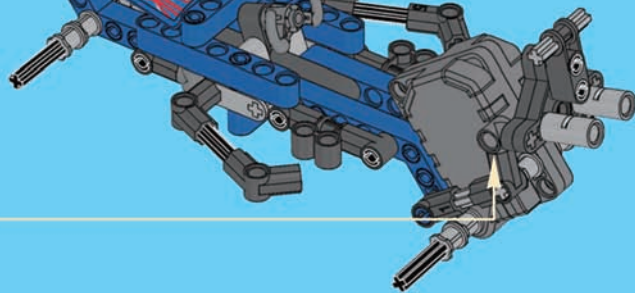



1

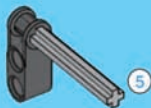

2

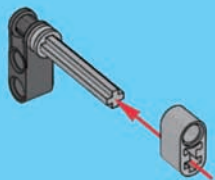

3

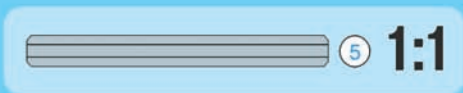
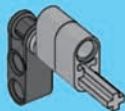

5 1:1



4

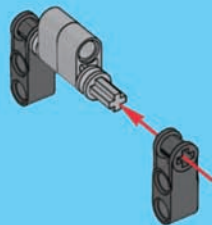

5

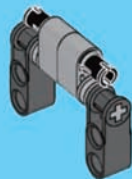



6

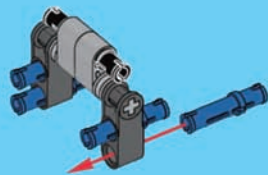

7

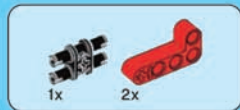
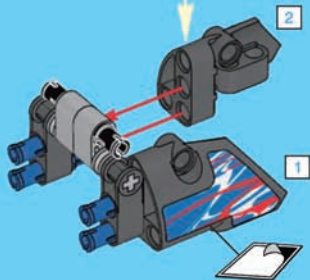
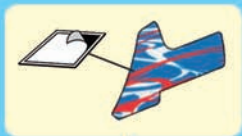

1

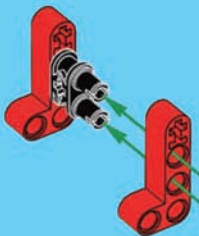

2

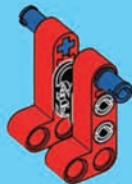

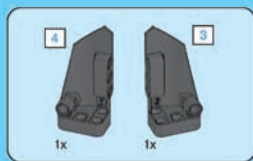

3

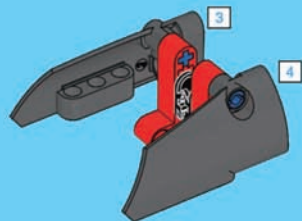

4

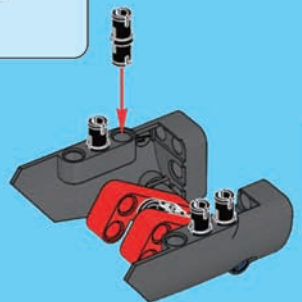

5

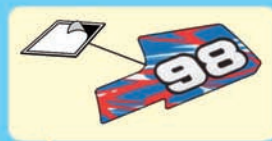

6

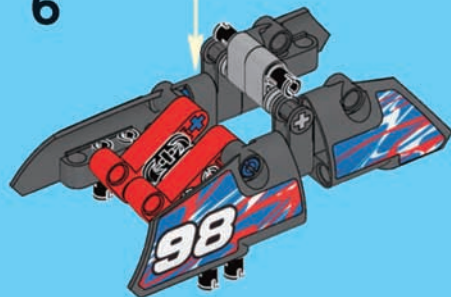



7

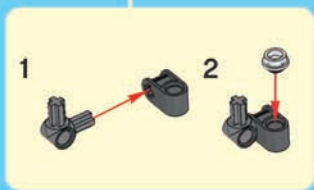
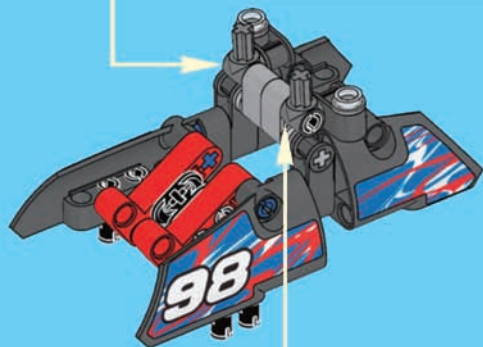
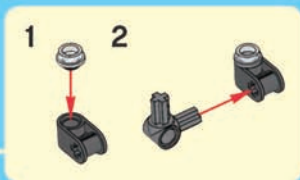

24

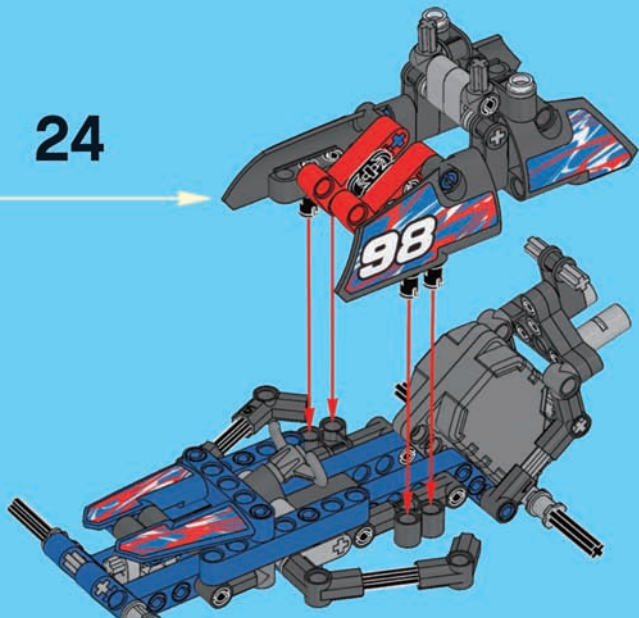



1

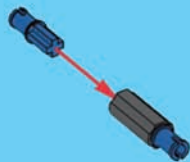

2



3

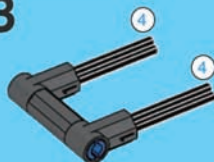

4

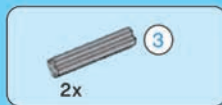

5





6

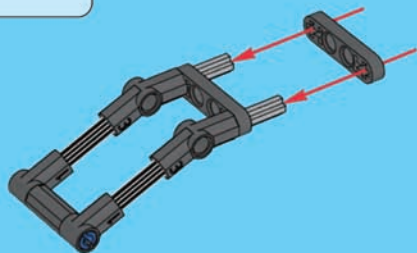

7

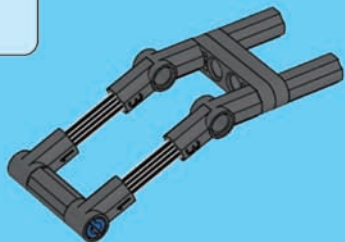

25

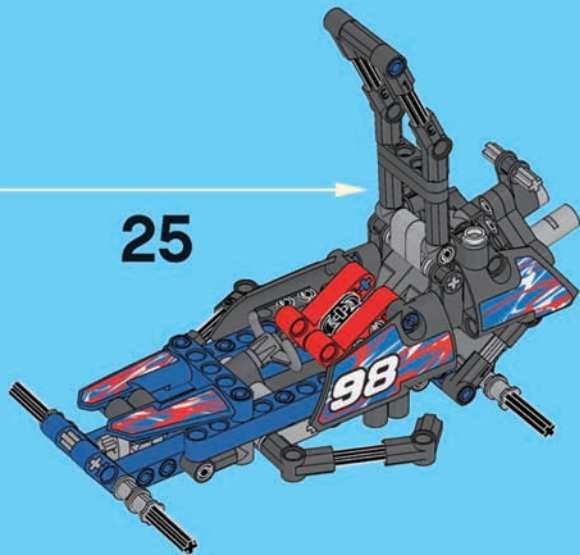



26

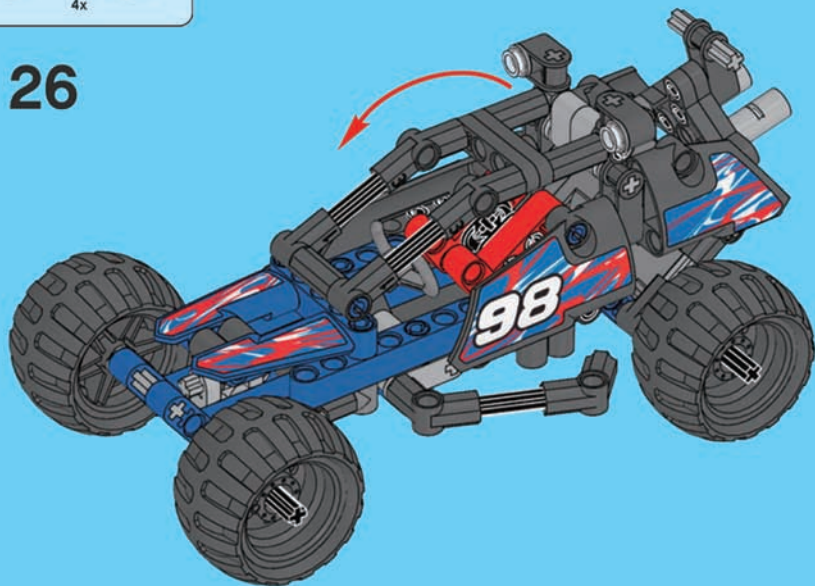



27

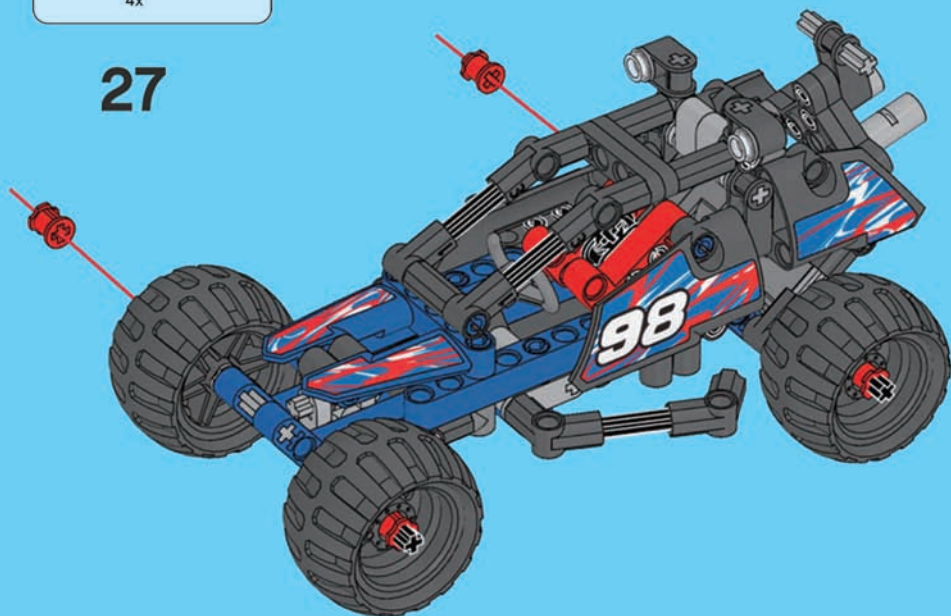



28

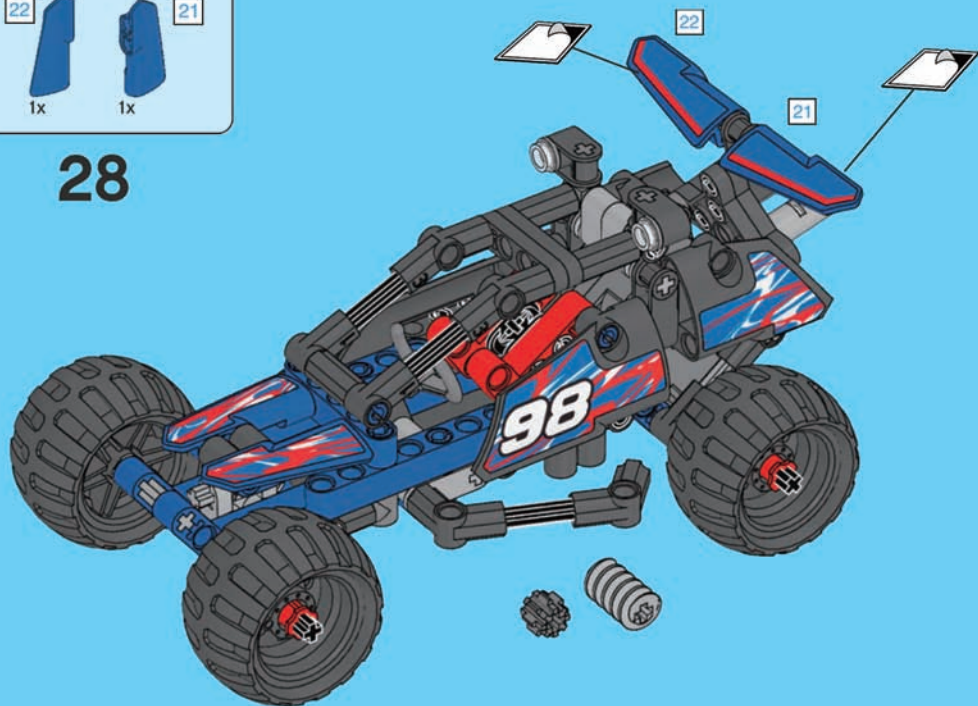



3411



3412



COMBINATION



1

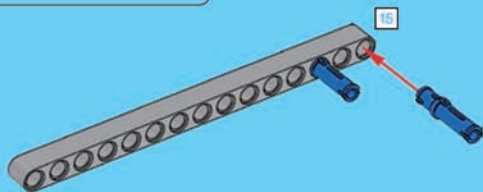
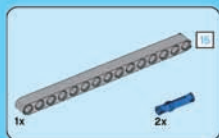

2

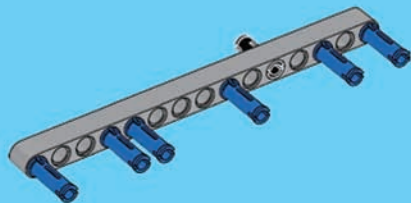

3

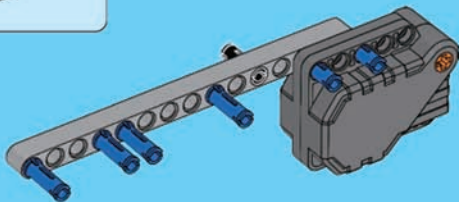

4

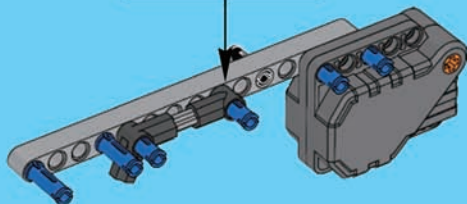
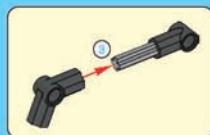



5

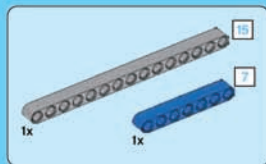
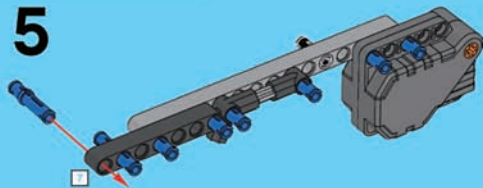

6

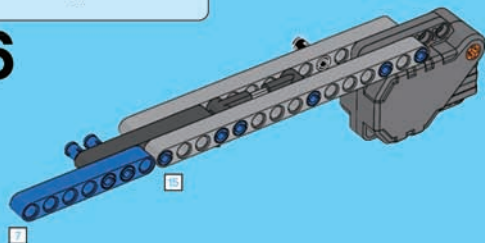

7

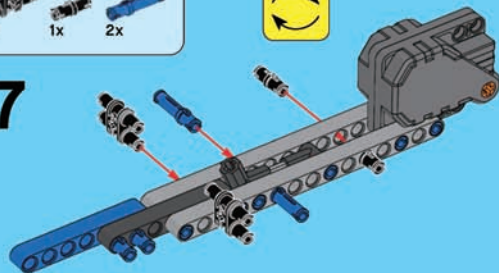

8

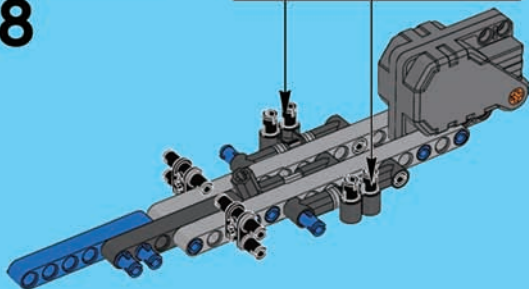
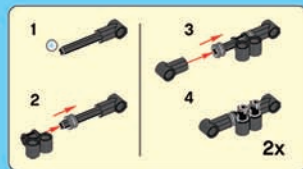

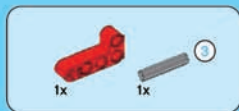

1



2



3

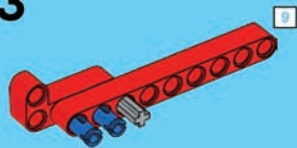

4

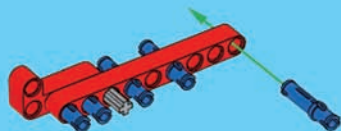



5

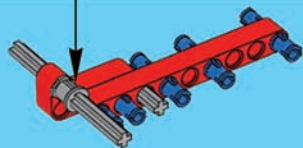
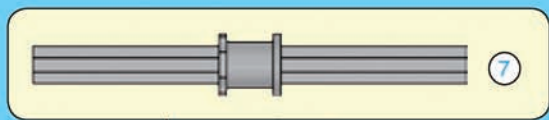

6

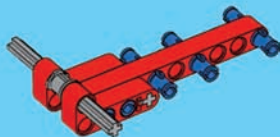

9

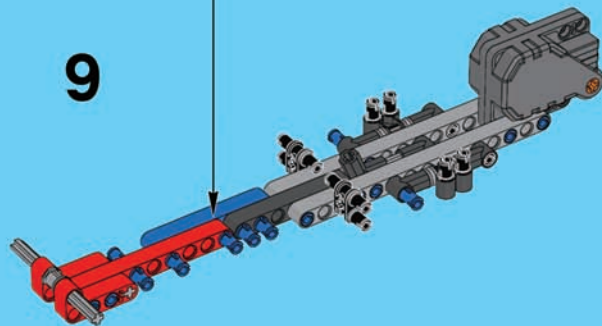

10

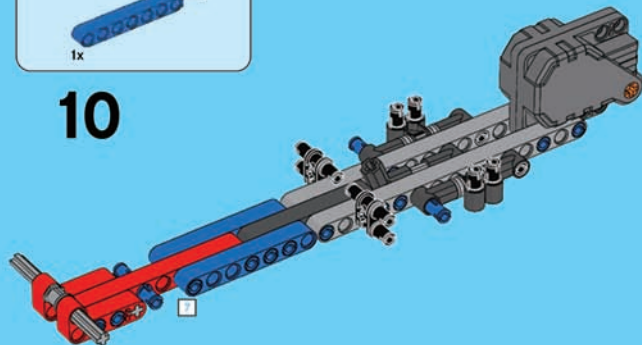



11

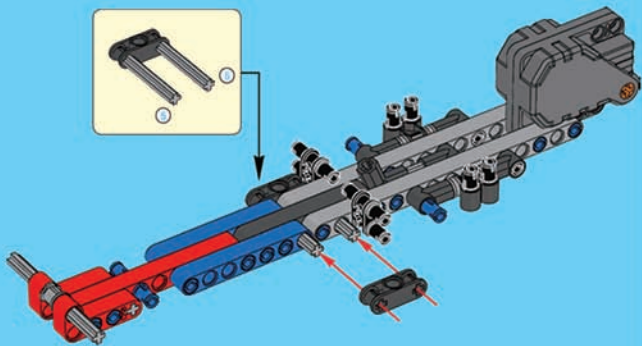

12

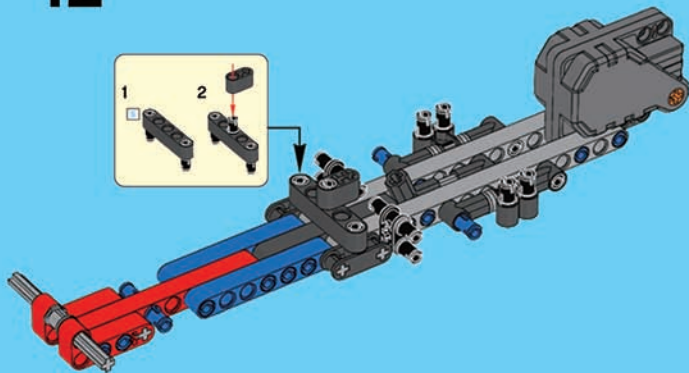
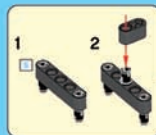



13

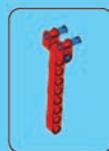
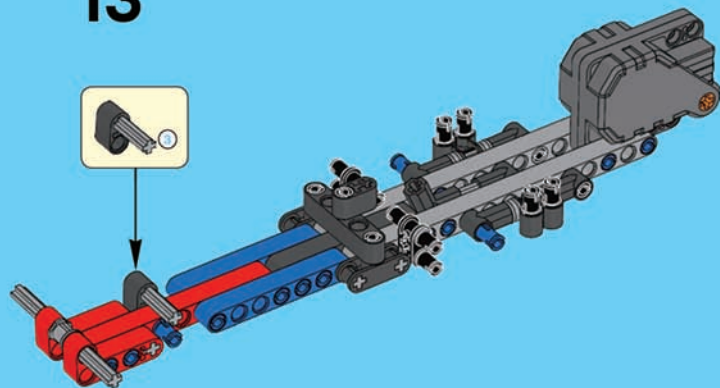

1

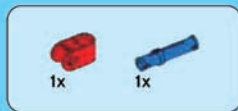

2

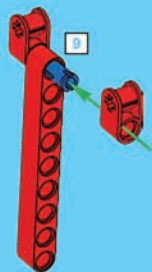

3





14

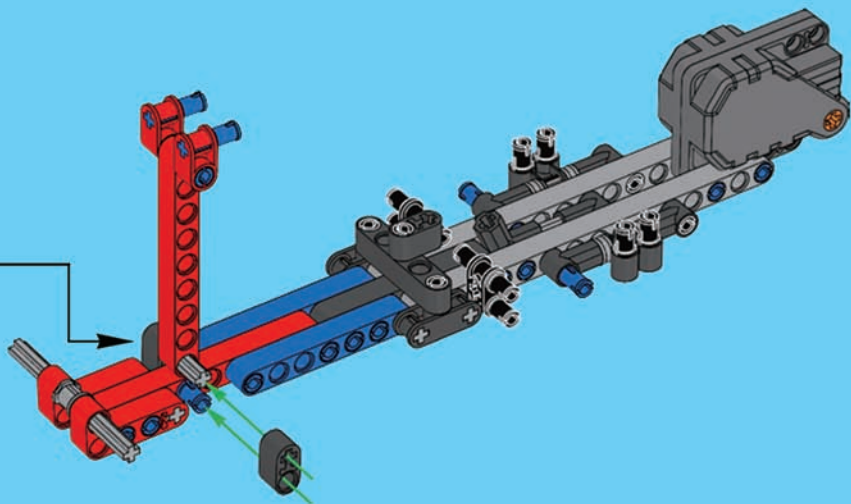

15

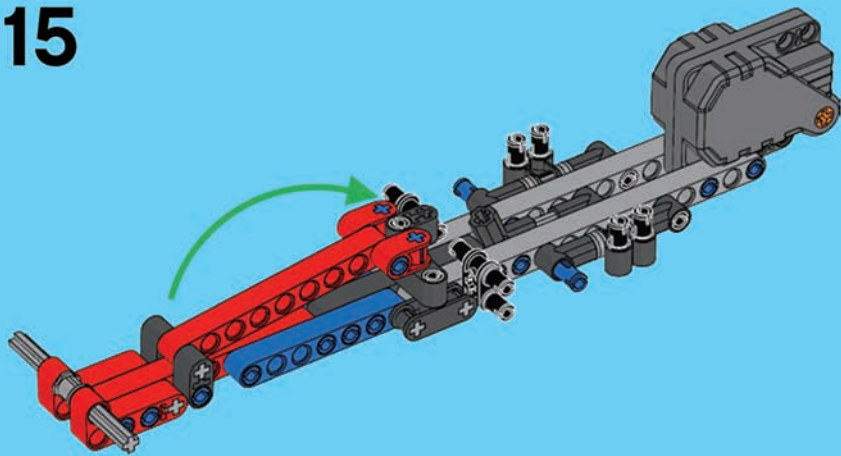

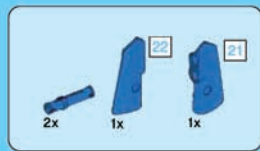

16

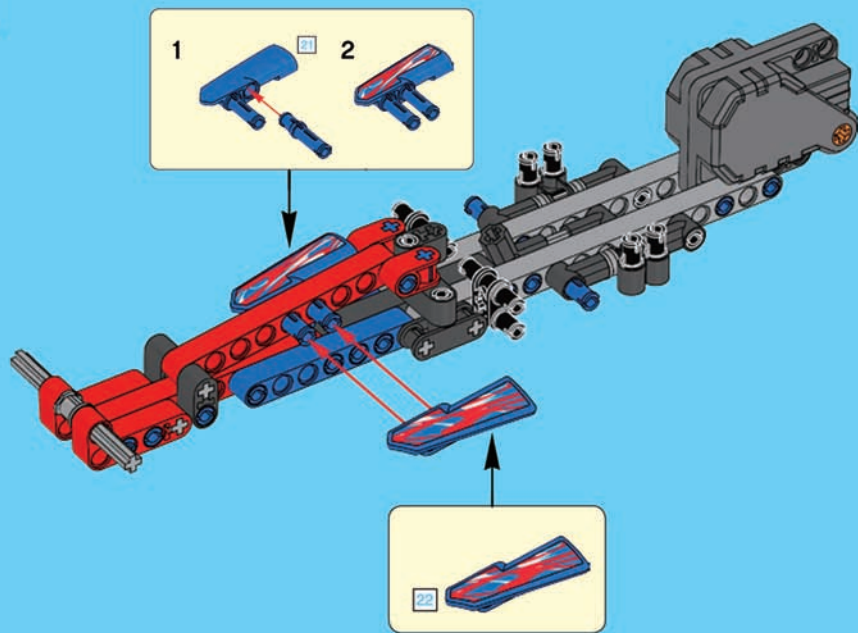



17

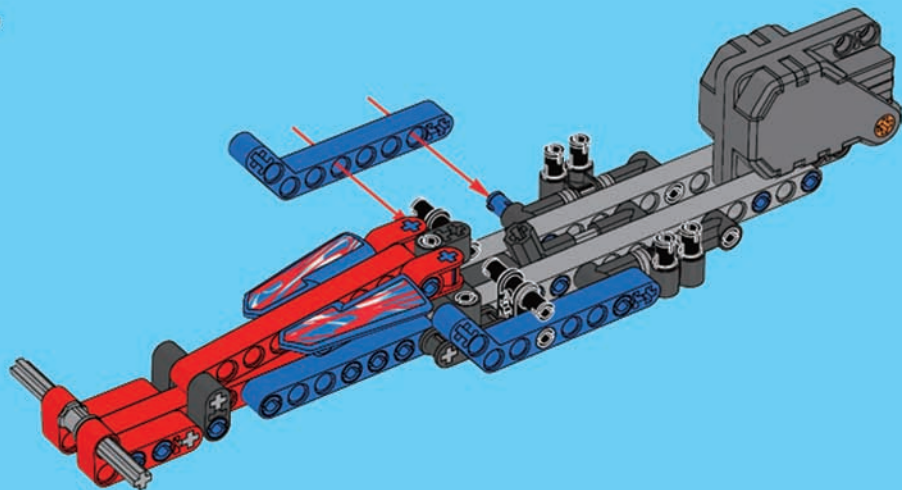



18

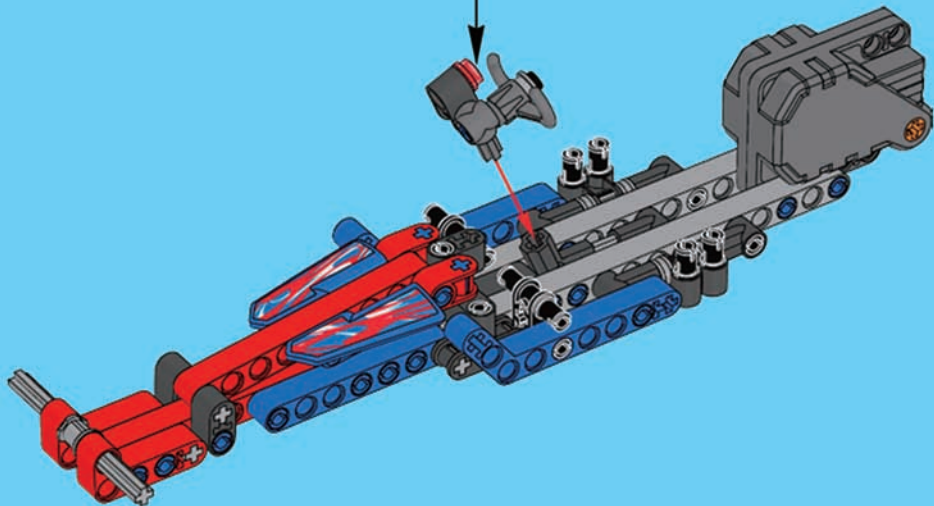
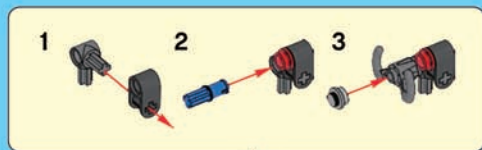



1

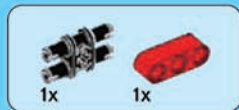

2



3



4

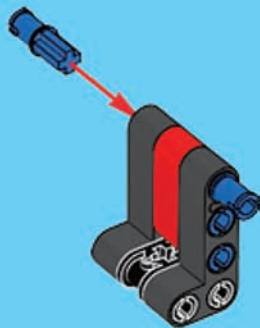

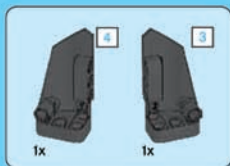

5

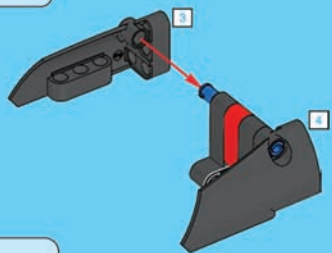

6

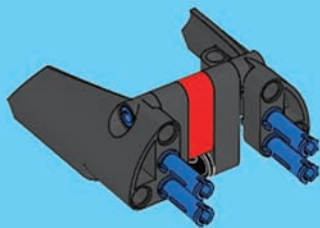

7



1



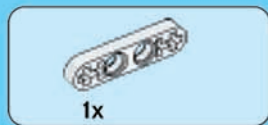

2

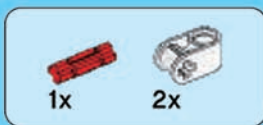

3

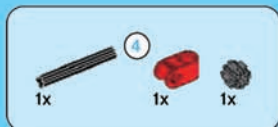

4

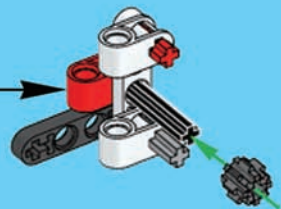

5

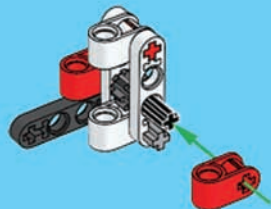

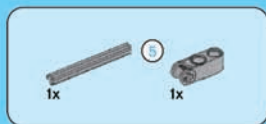

6

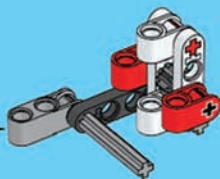

7



8

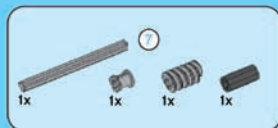
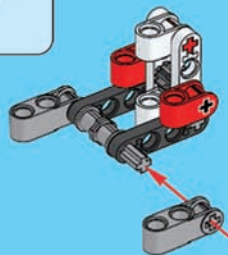

9

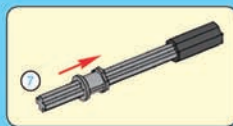

接下来的组装步骤请查阅(3412)
For the following assembly instructions,
please refer to(3412)