

ЭЛЕКТРОННЫЙ КОНСТРУКТОР

ЭВРИКИ

6+

85

ДЕТАЛЕЙ



СОБЕРИ САМ



РАБОТАЕТ
ОТ БАТАРЕЕК



АВИАЦИЯ ИНСТРУКЦИЯ



УПРАВЛЕНИЕ ИГРУШКОЙ

Вперёд/назад

Влево/вправо

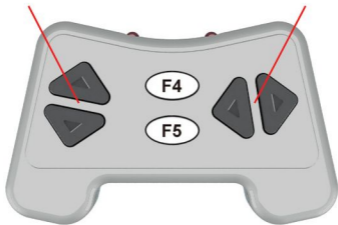

С помощью пульта вы можете управлять движением игрушки вперёд/назад и влево/вправо. Для этого нажимайте соответствующие стрелочки.

Кнопка F4 – при первом нажатии установка соединения с игрушкой. Следующее нажатие – прерывание связи. Повторное нажатие возобновляет управление (работает по принципу Вкл./Выкл.).

Кнопка F5 – включение инверсии: кнопки начинают работать наоборот (например, при нажатии стрелки «влево» игрушка начинает двигаться вправо). Нажатие F4 отключает функцию.

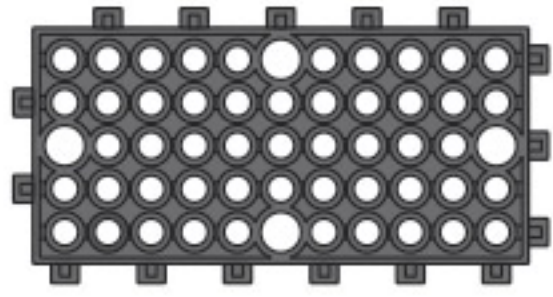

x4

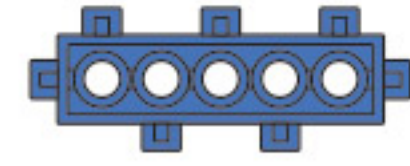

x12

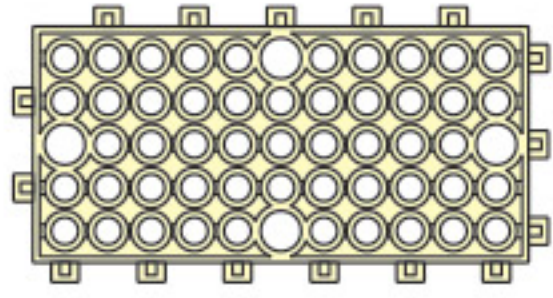

x2

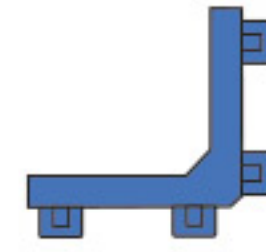

x2

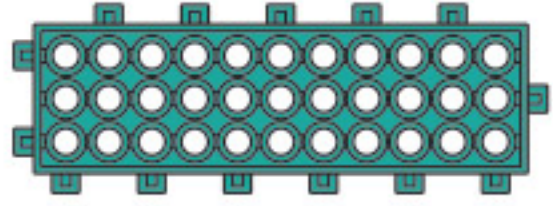

x4

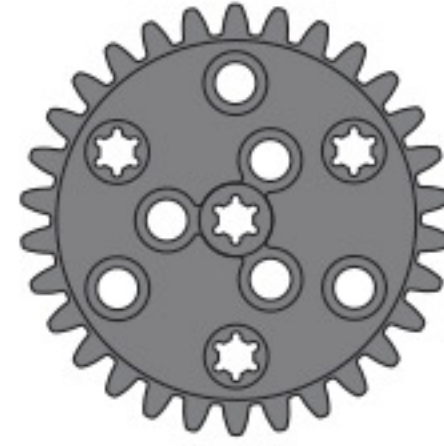

x4

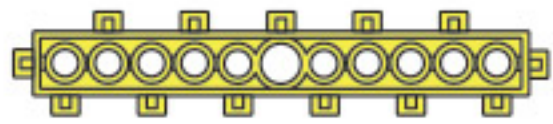

x1

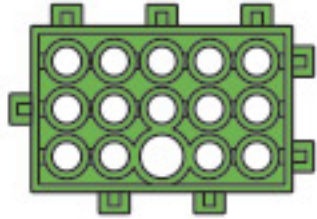

x8



x3

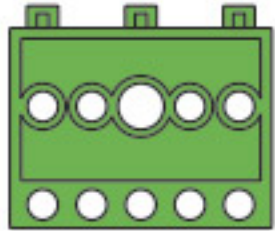

x4



x6

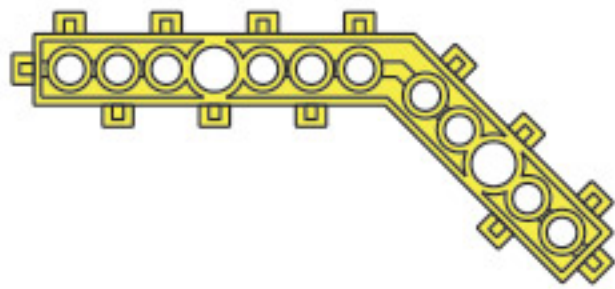

x4



x5



x3



x6



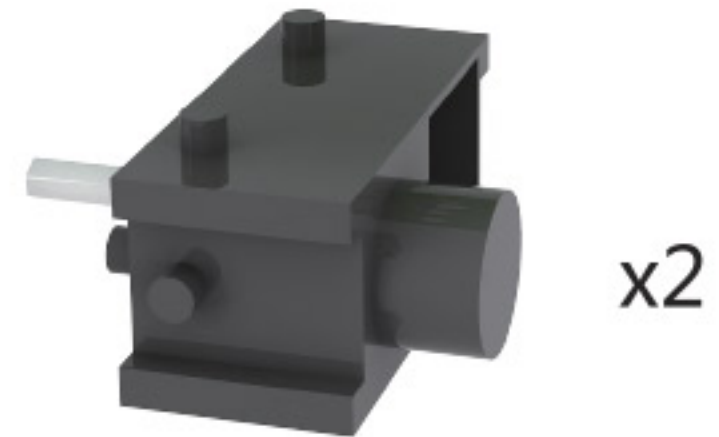

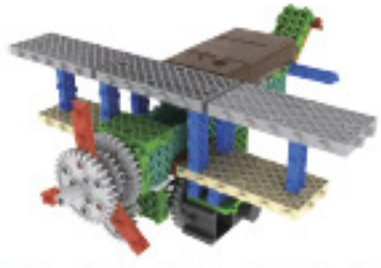

1

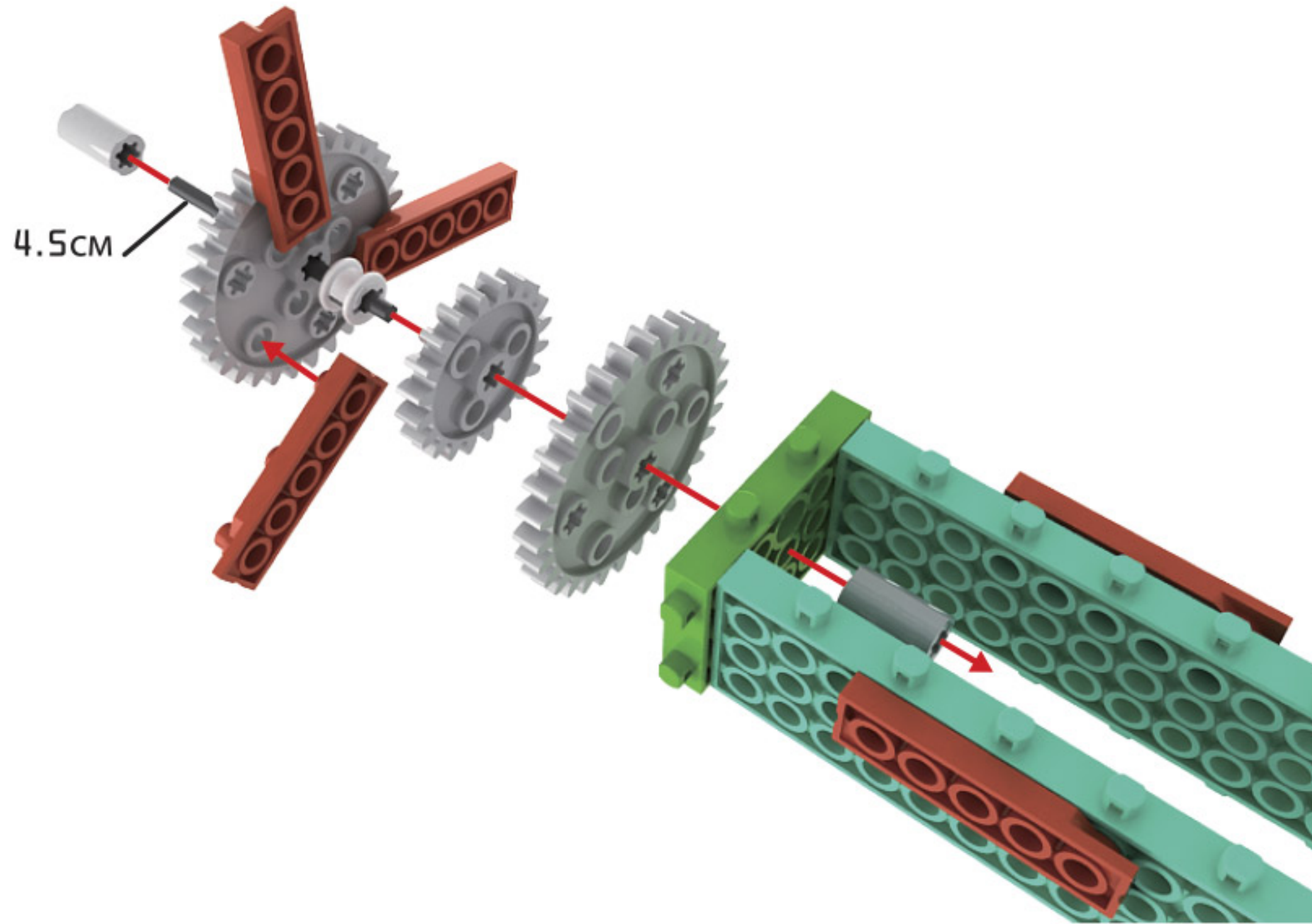
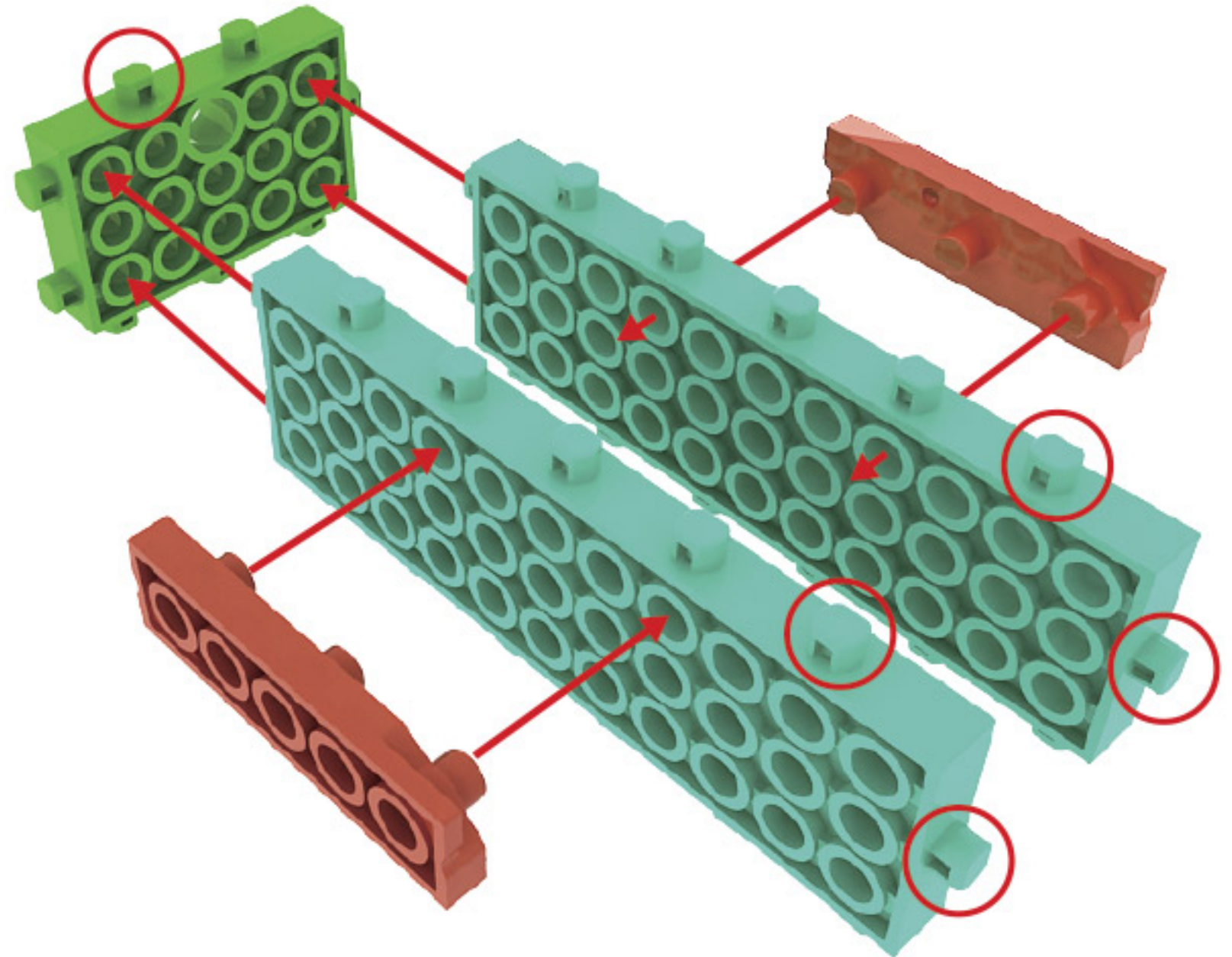

2

3

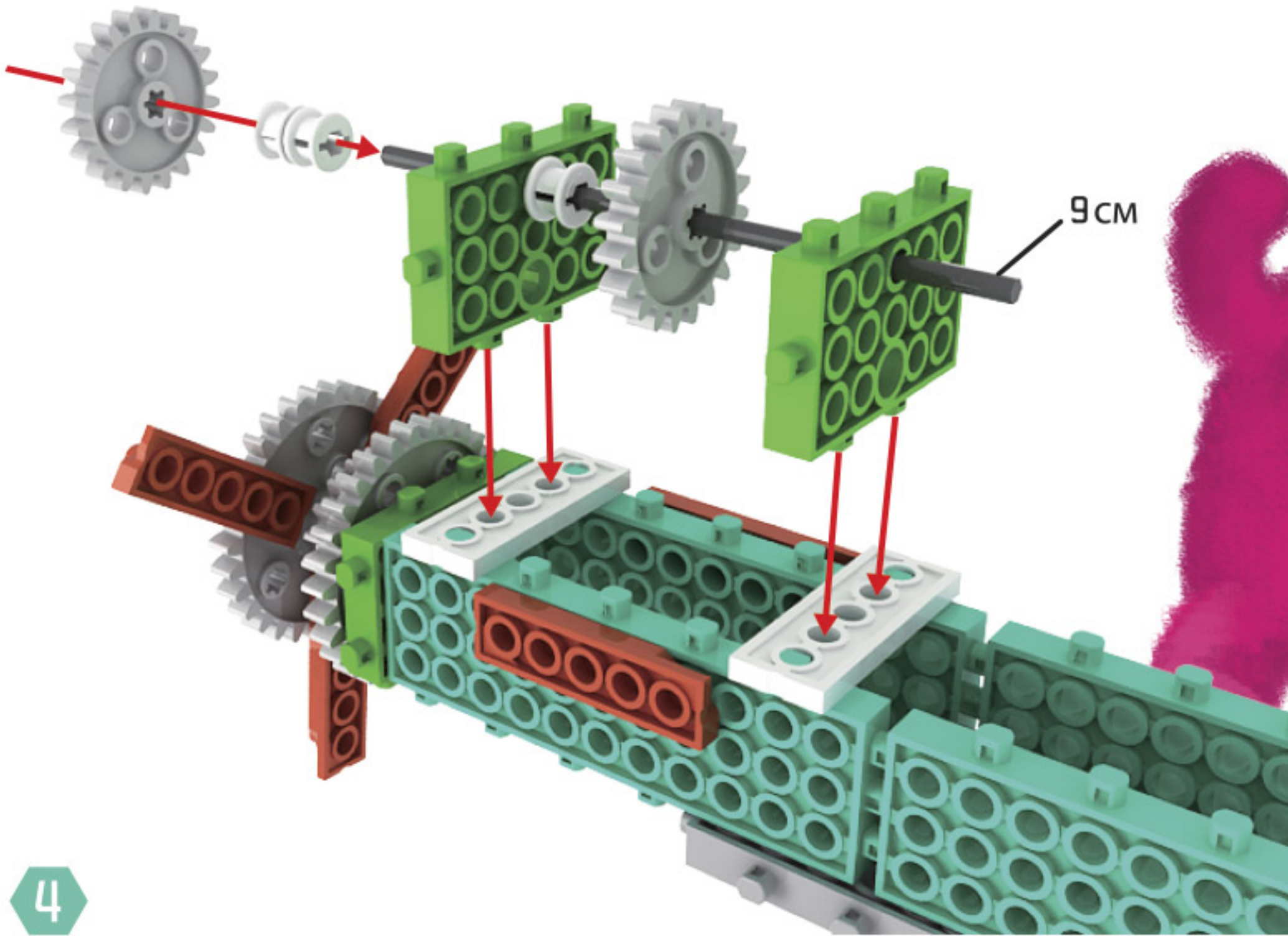
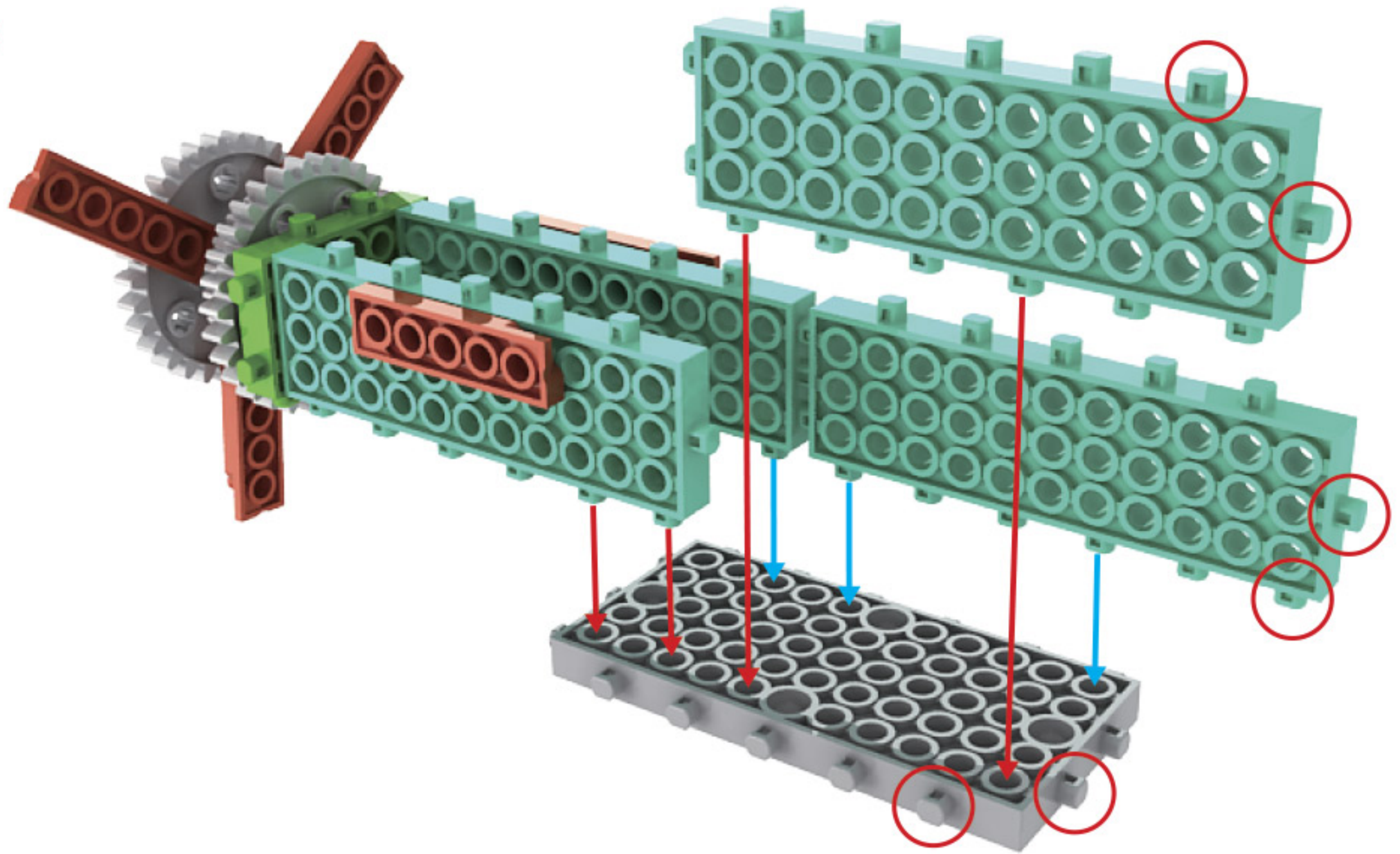

4

5

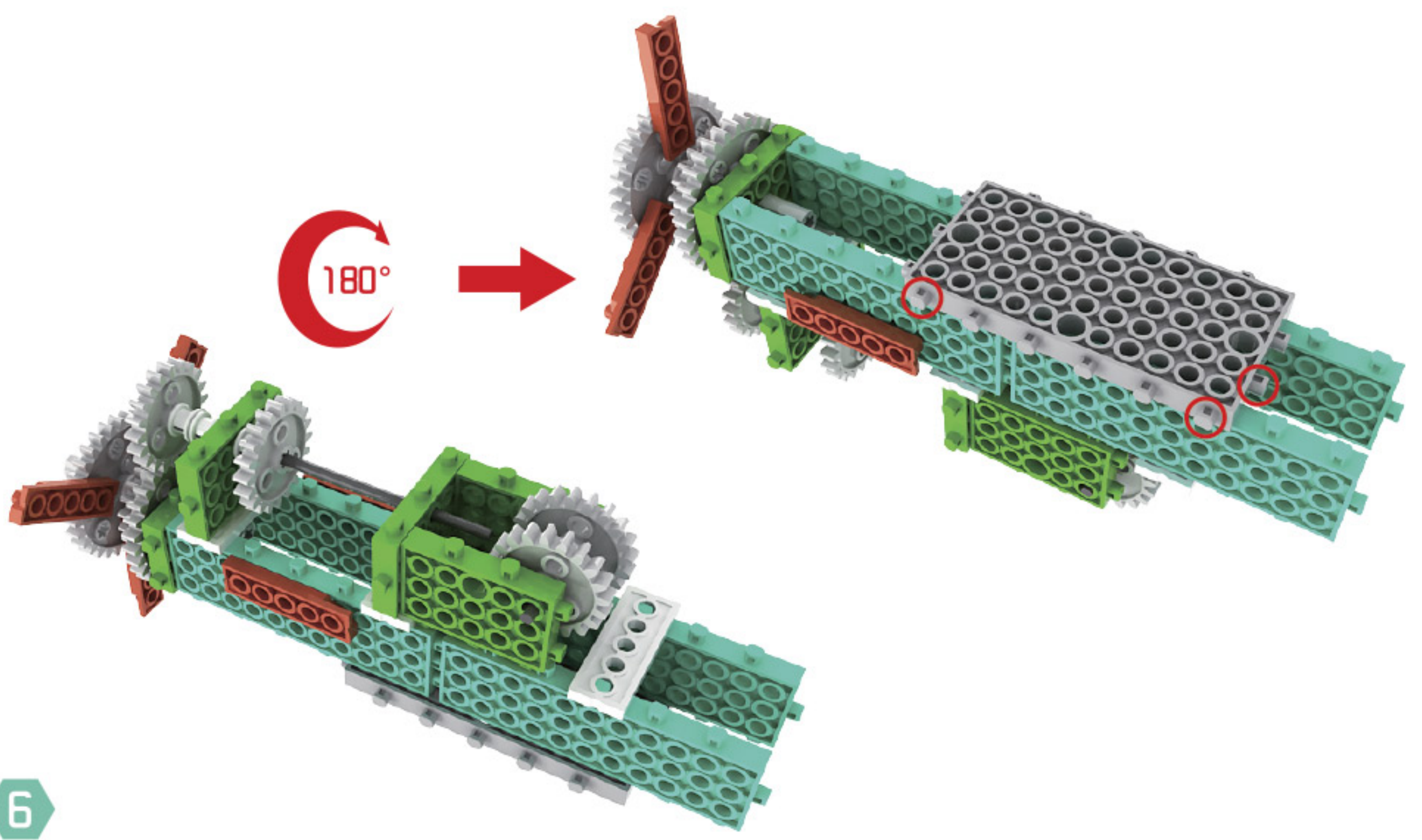
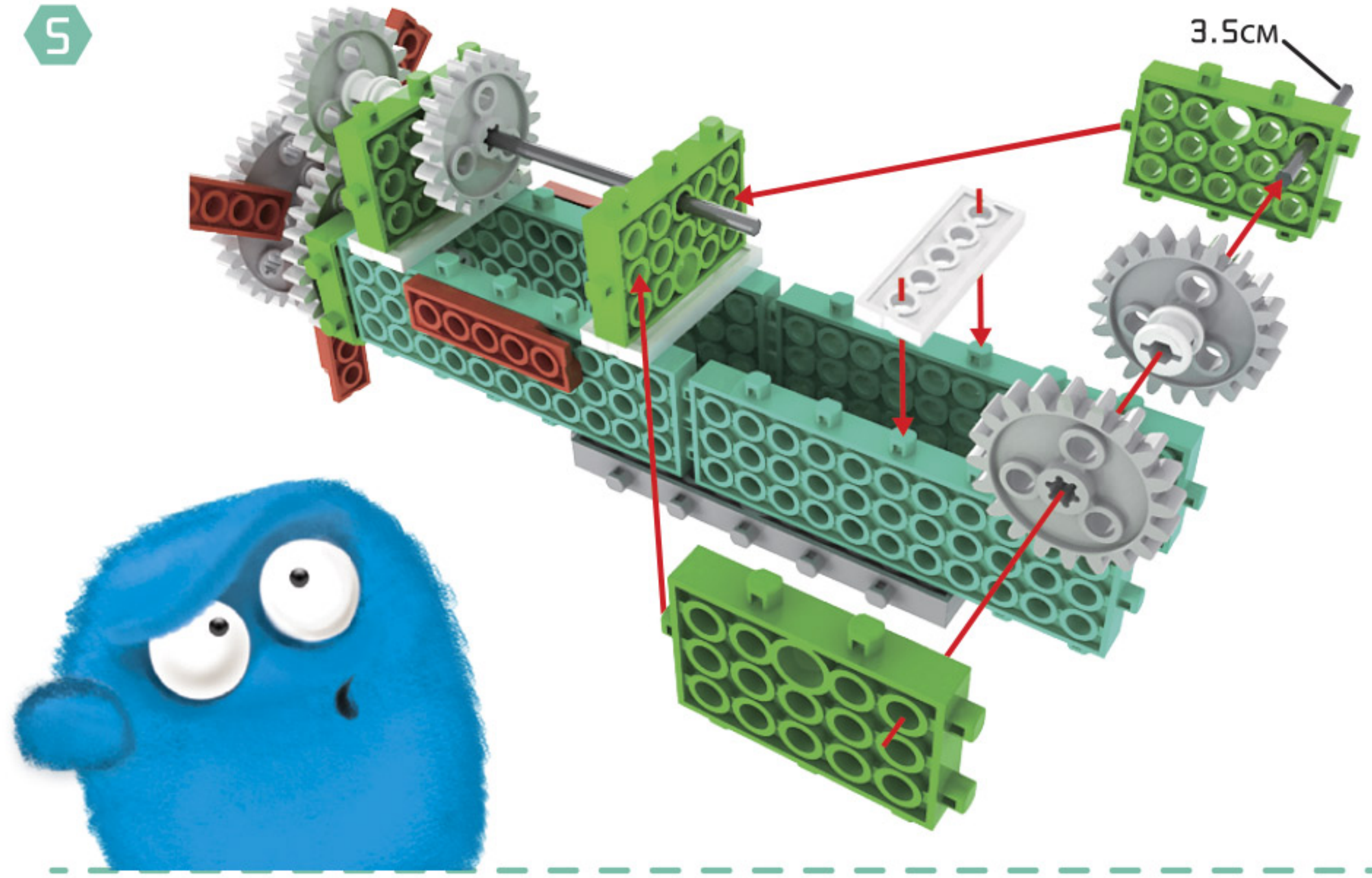

6

7

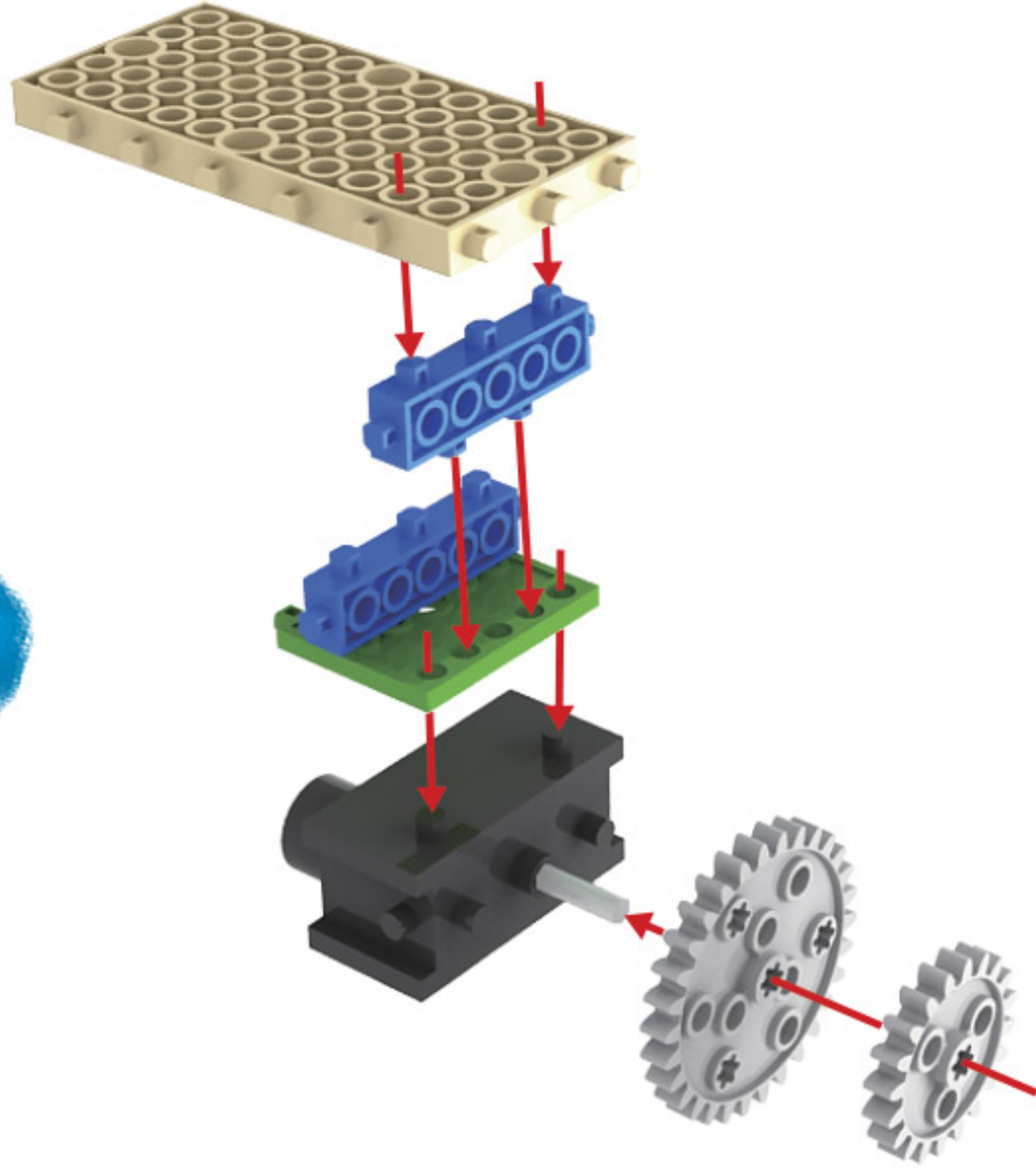

8

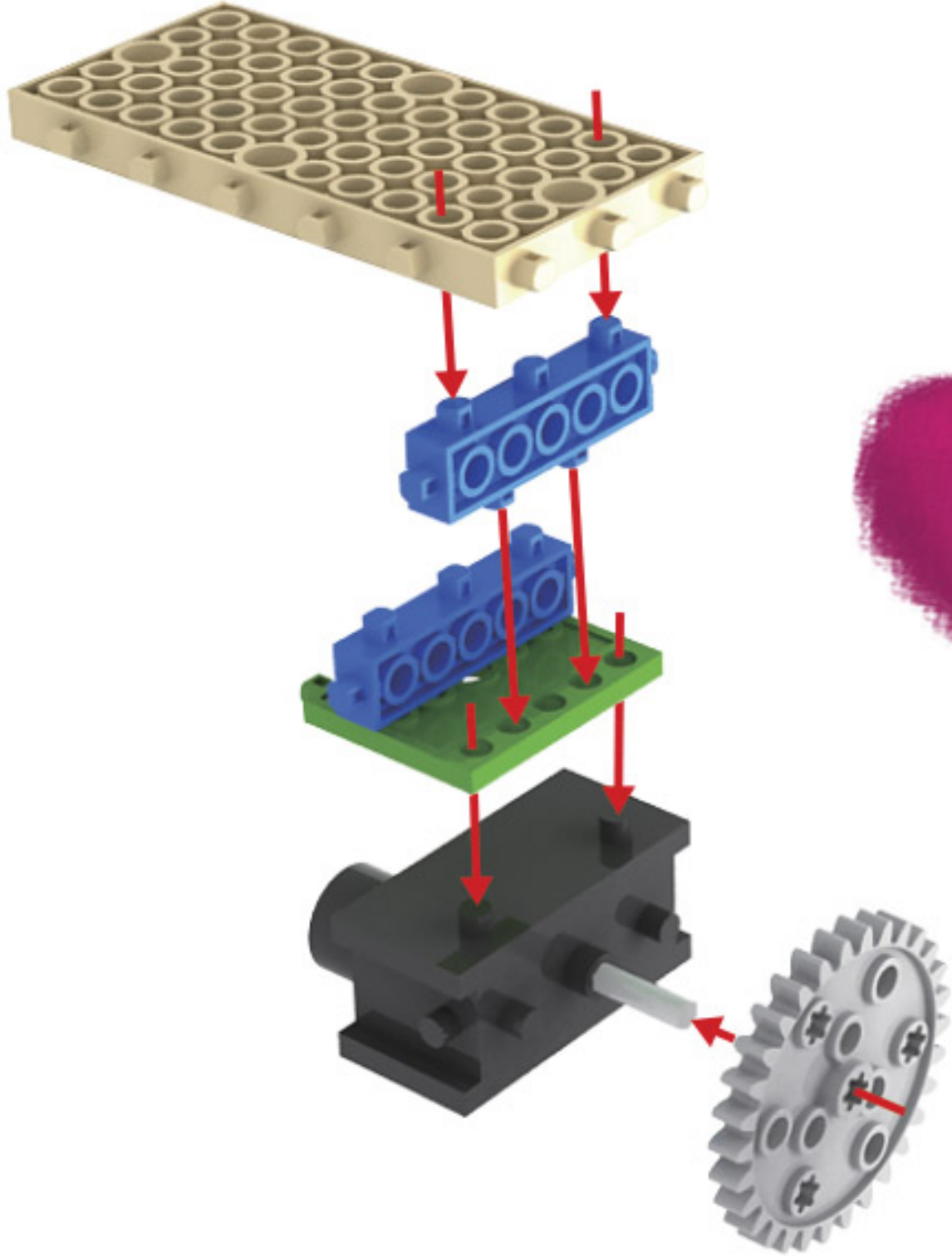

9

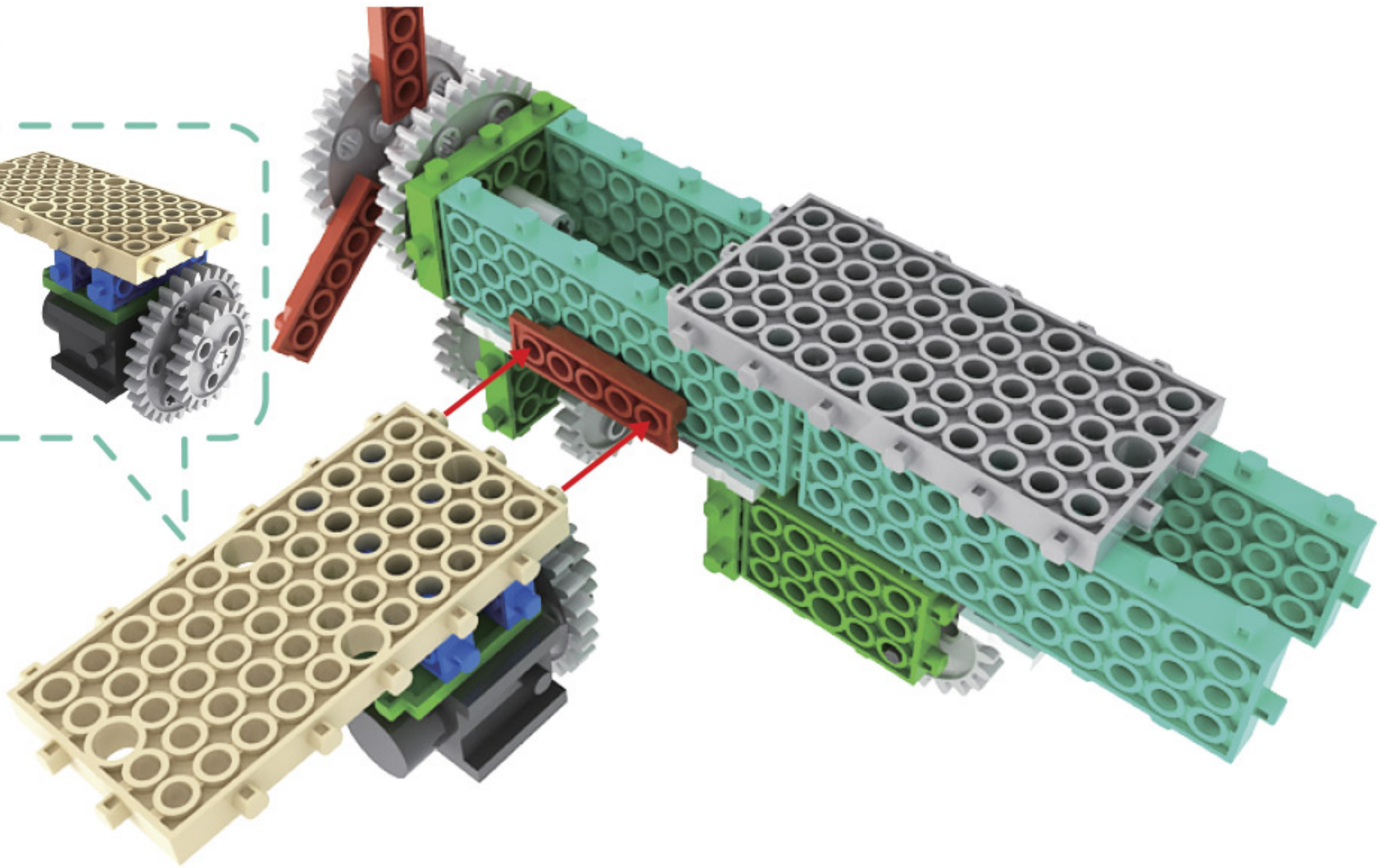
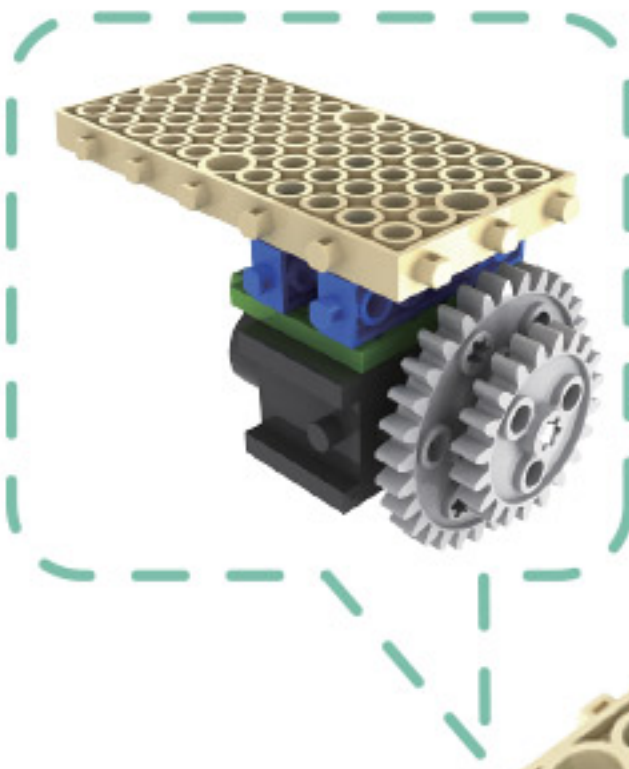

10

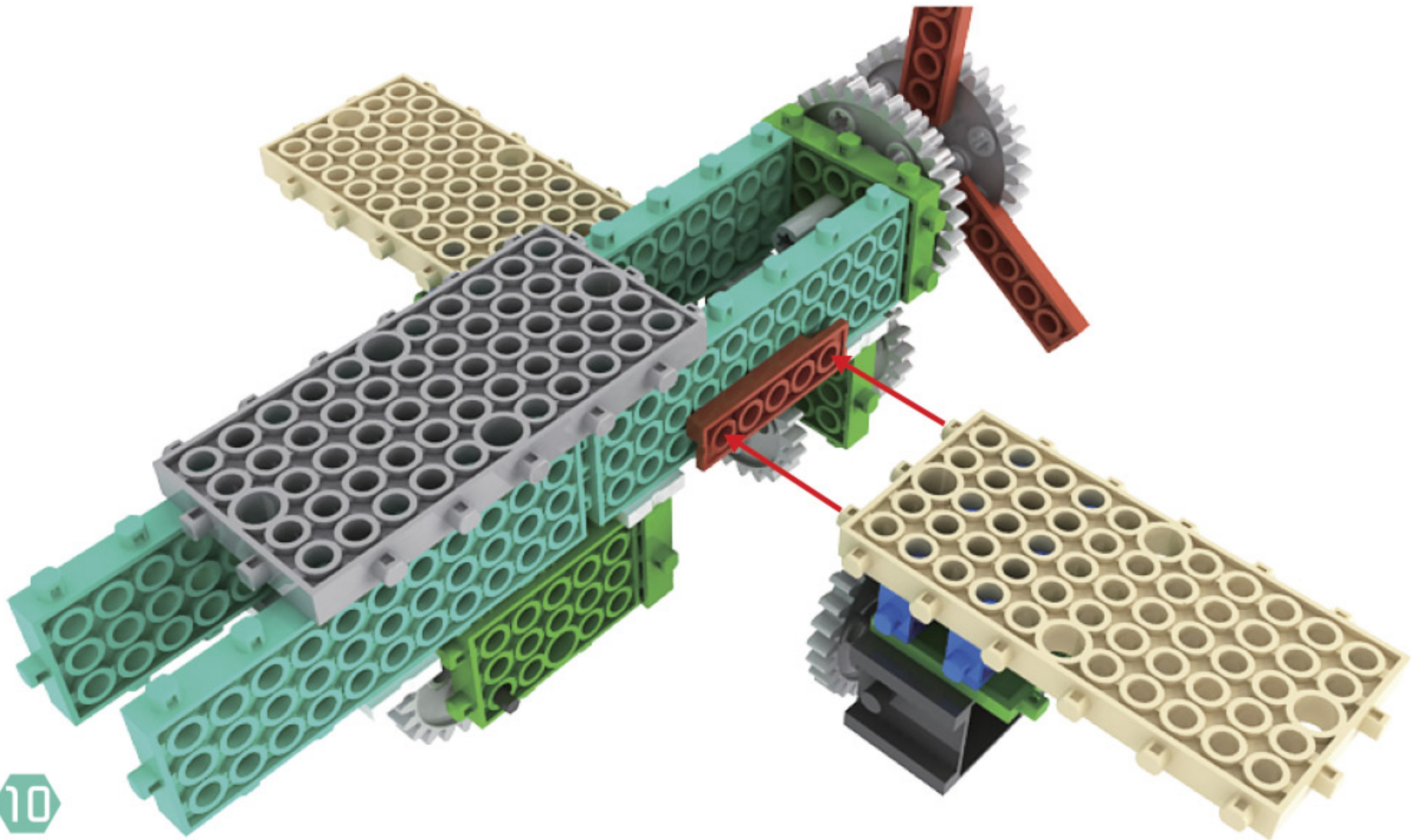

11

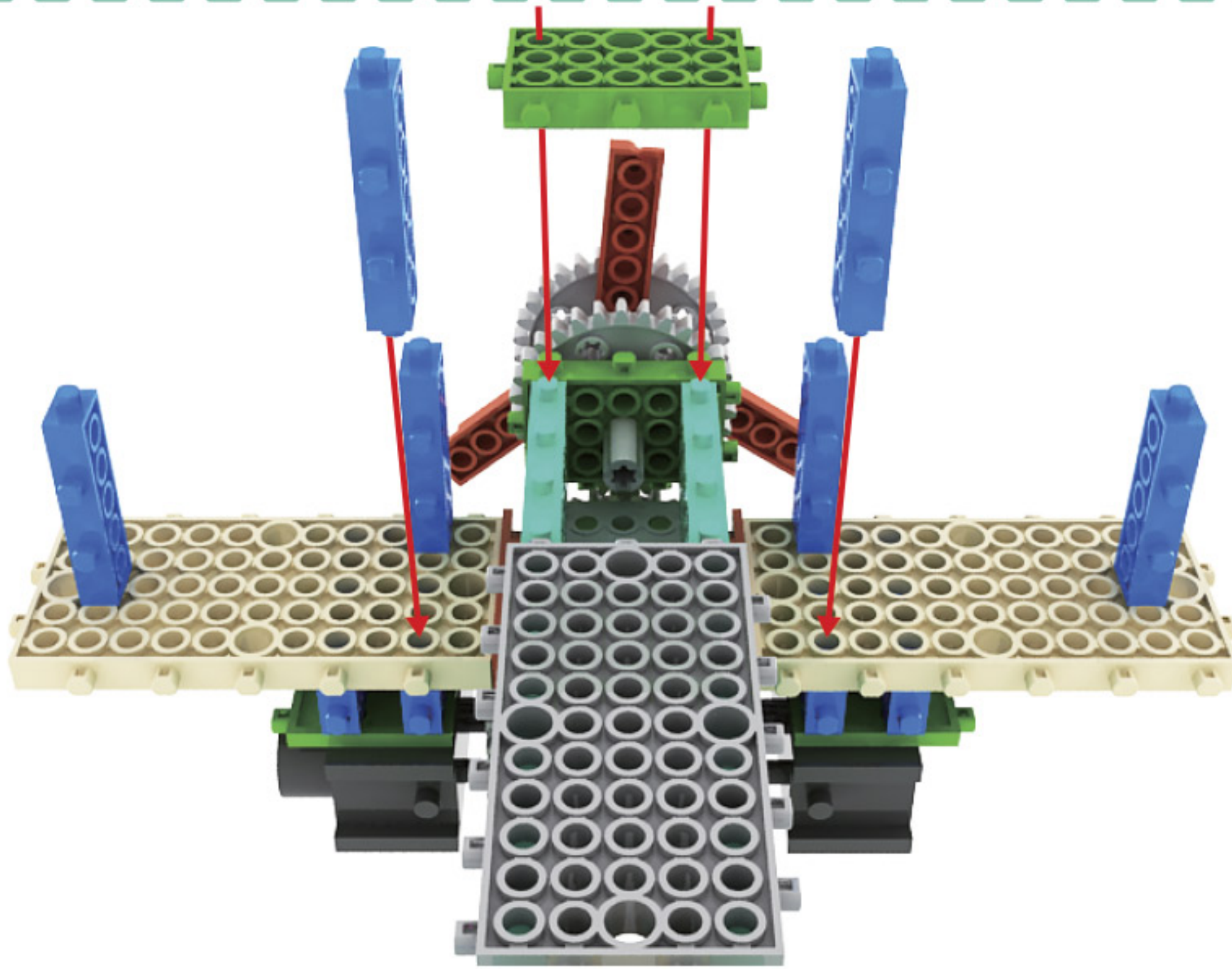

12

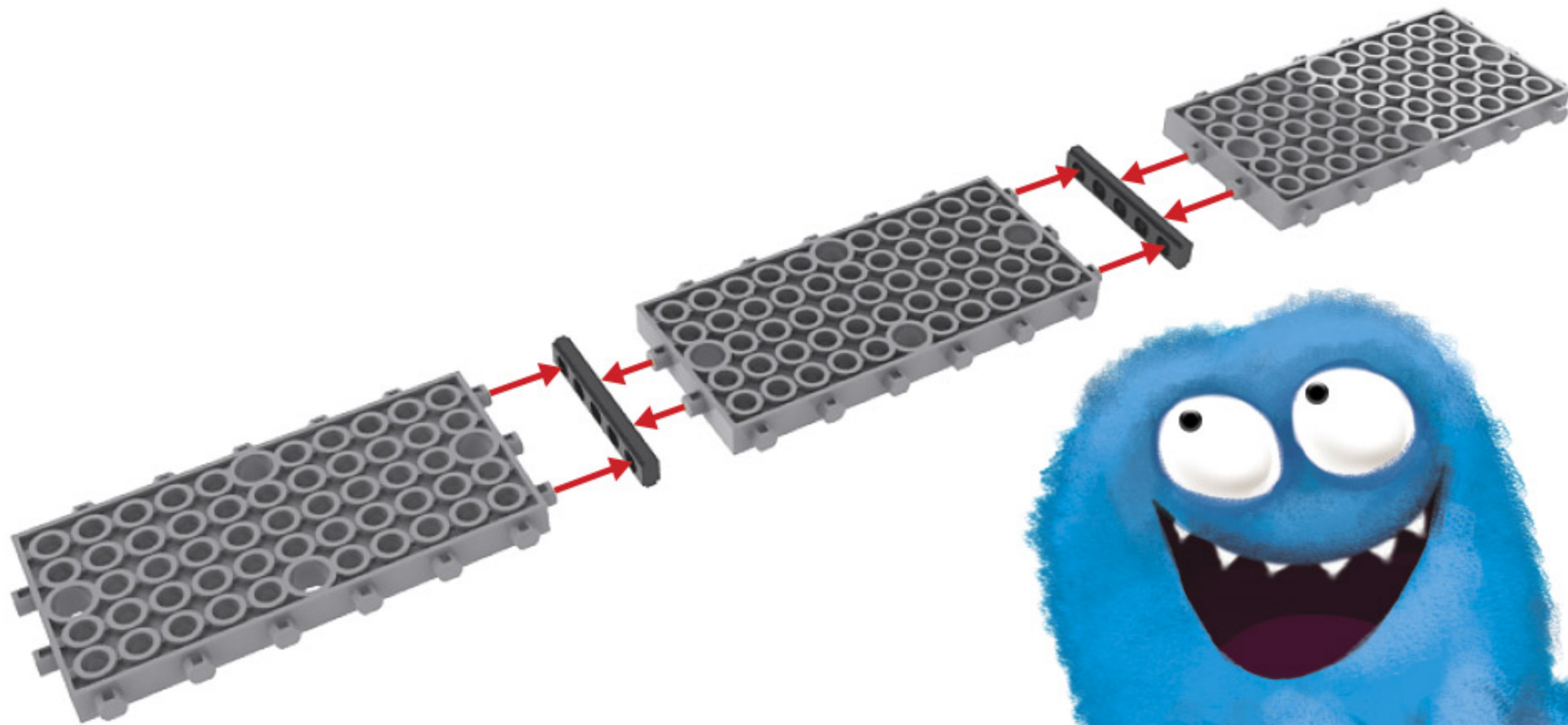

13

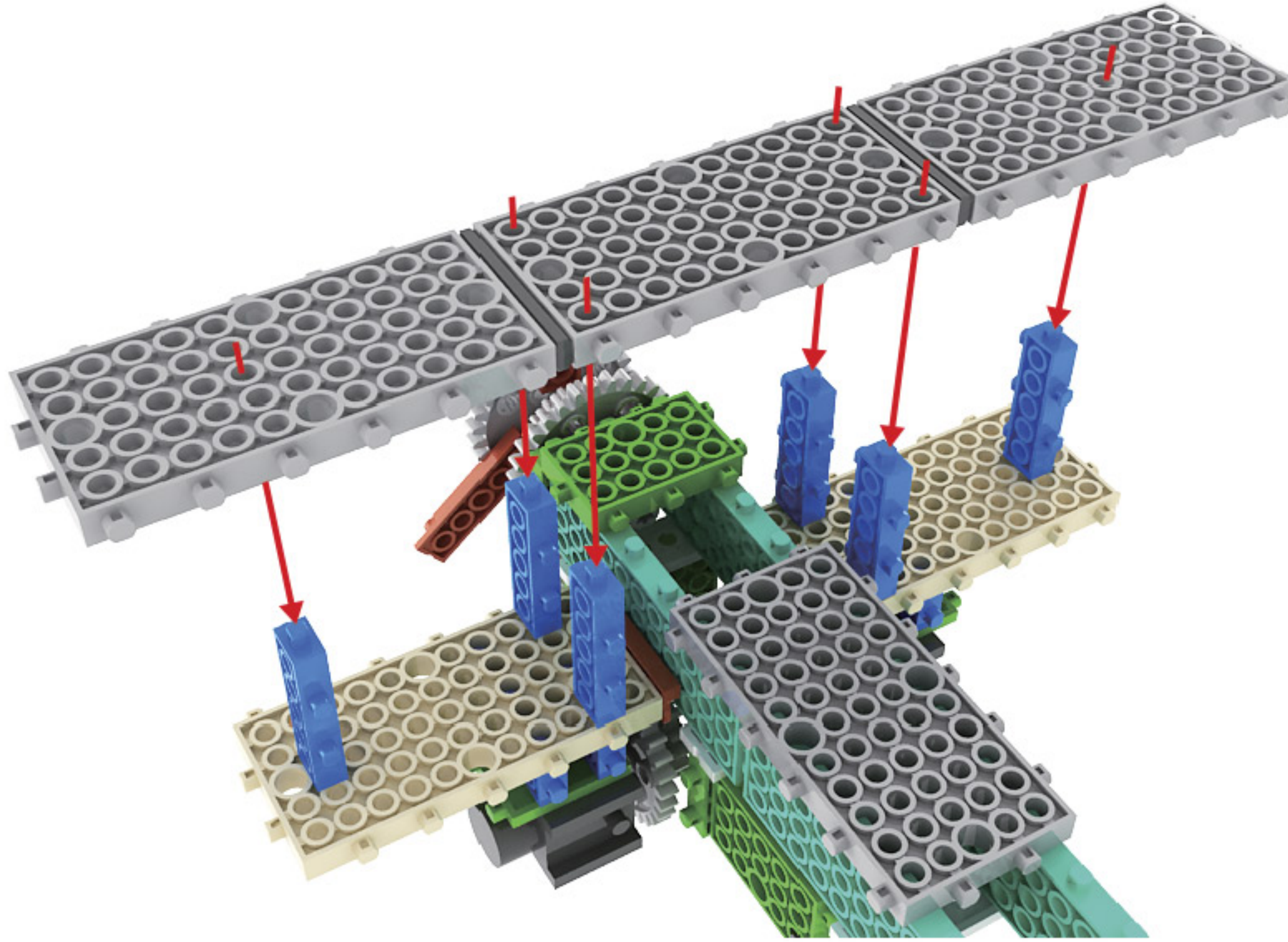

14

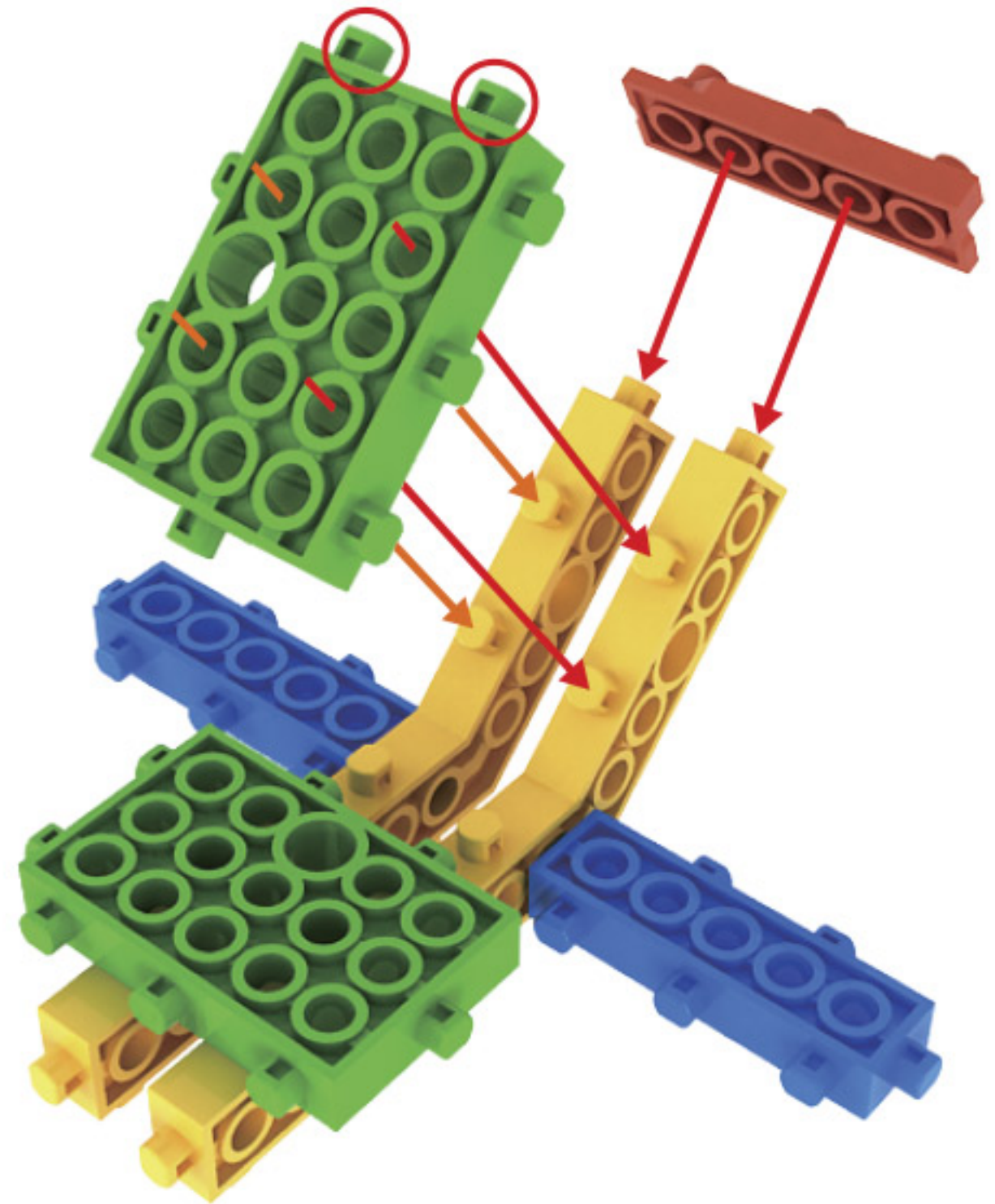
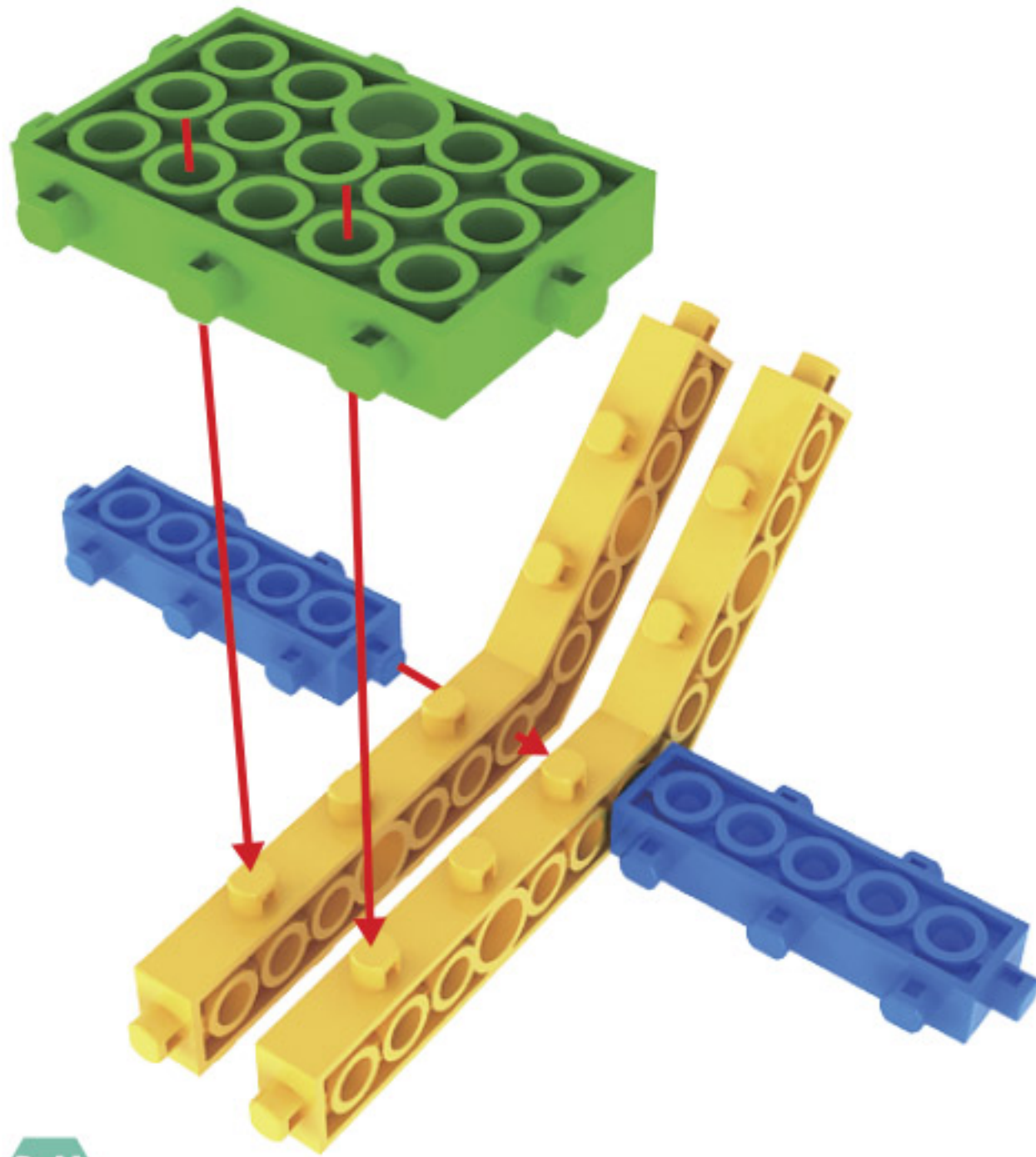

15

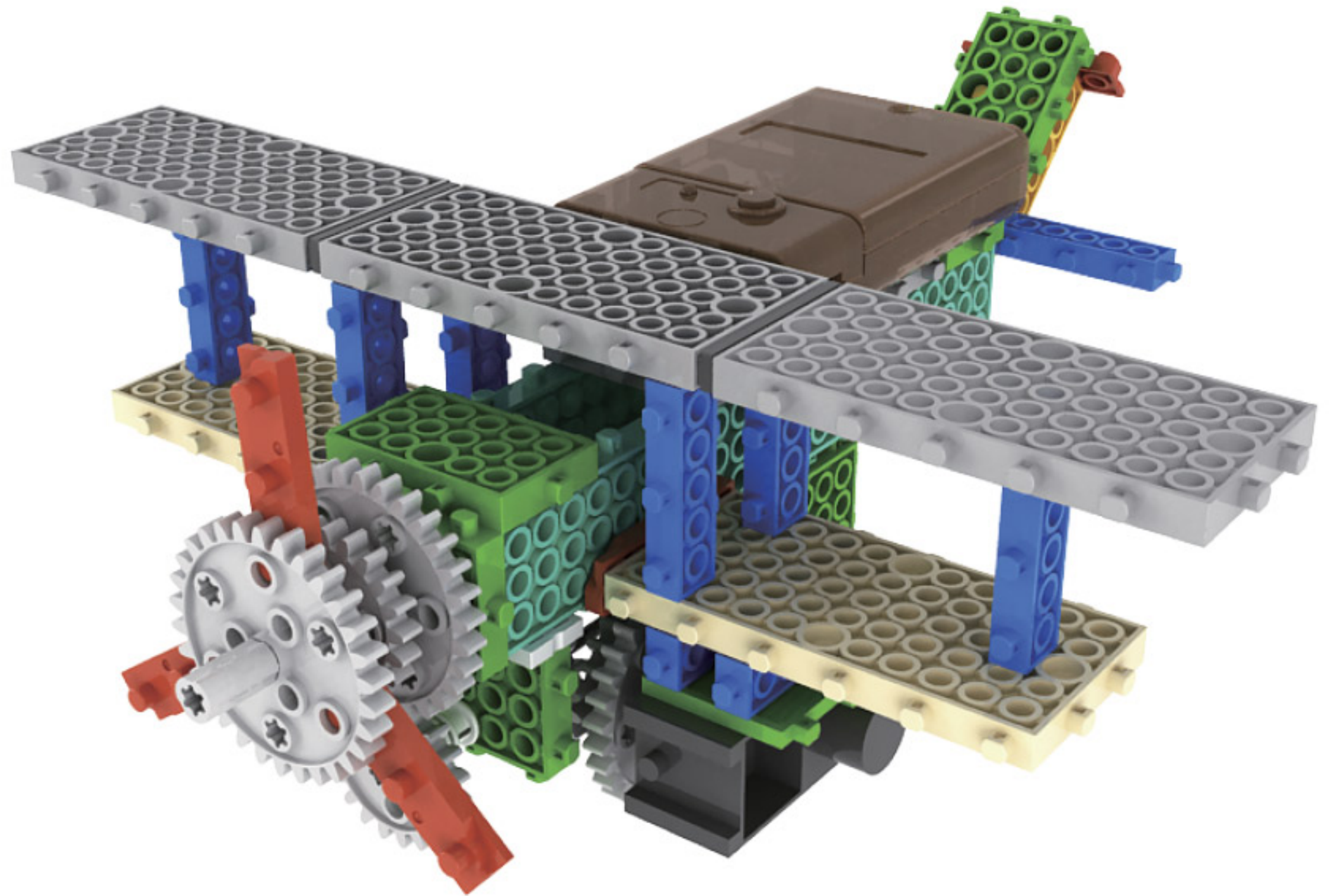
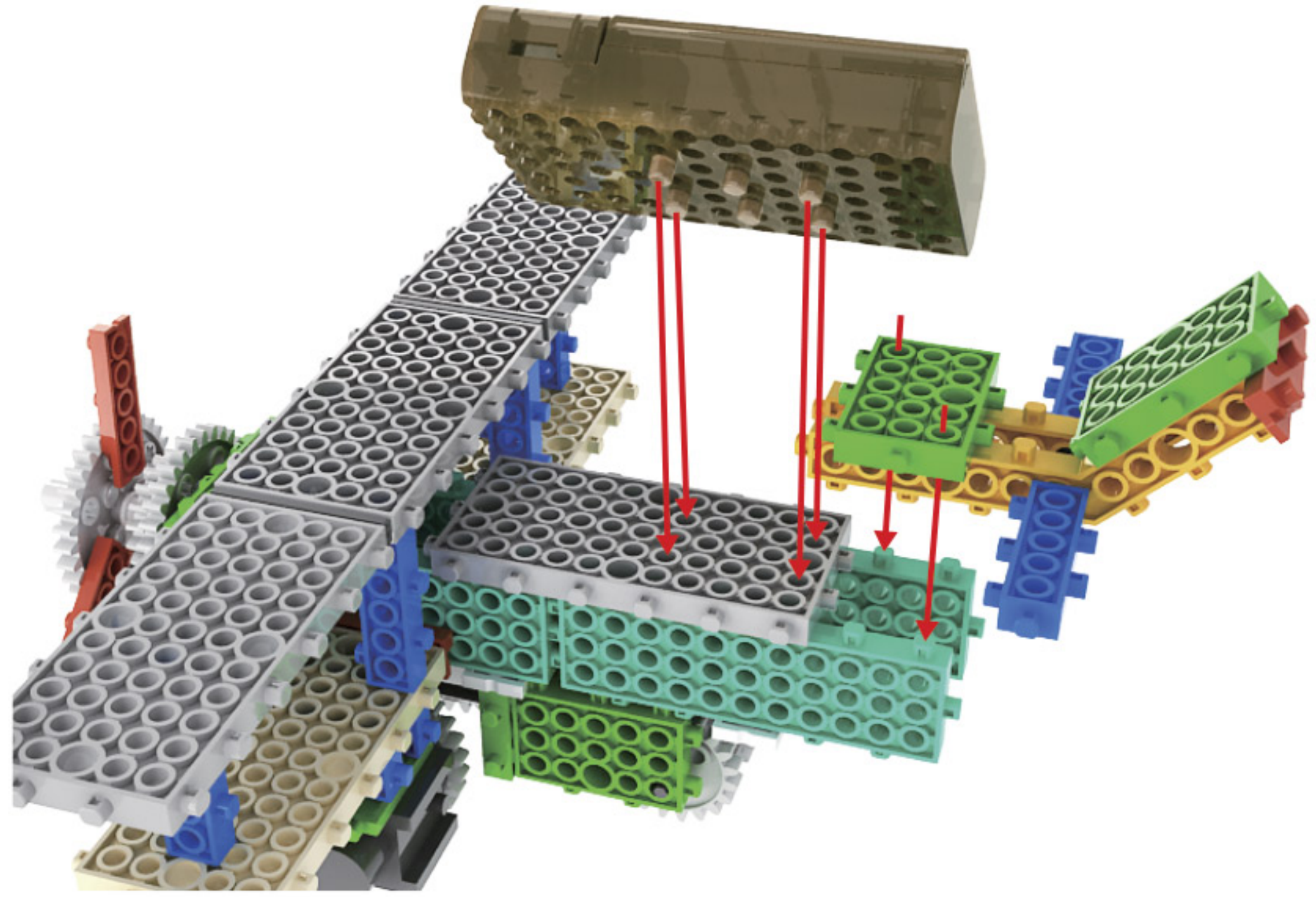

16

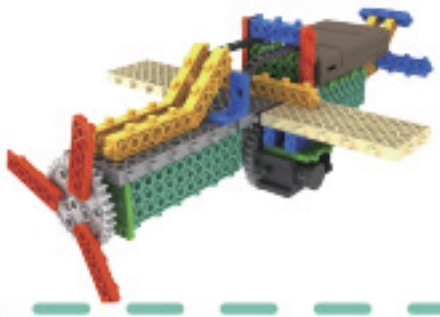

1

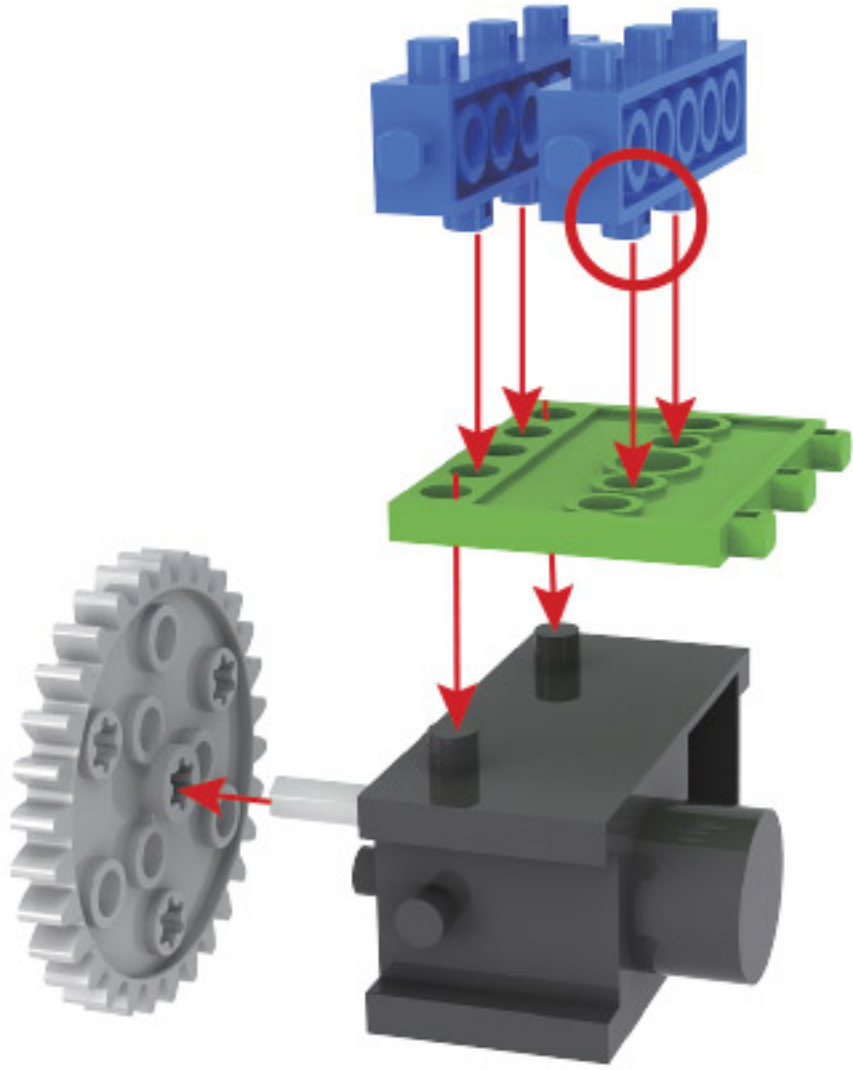

X2

2

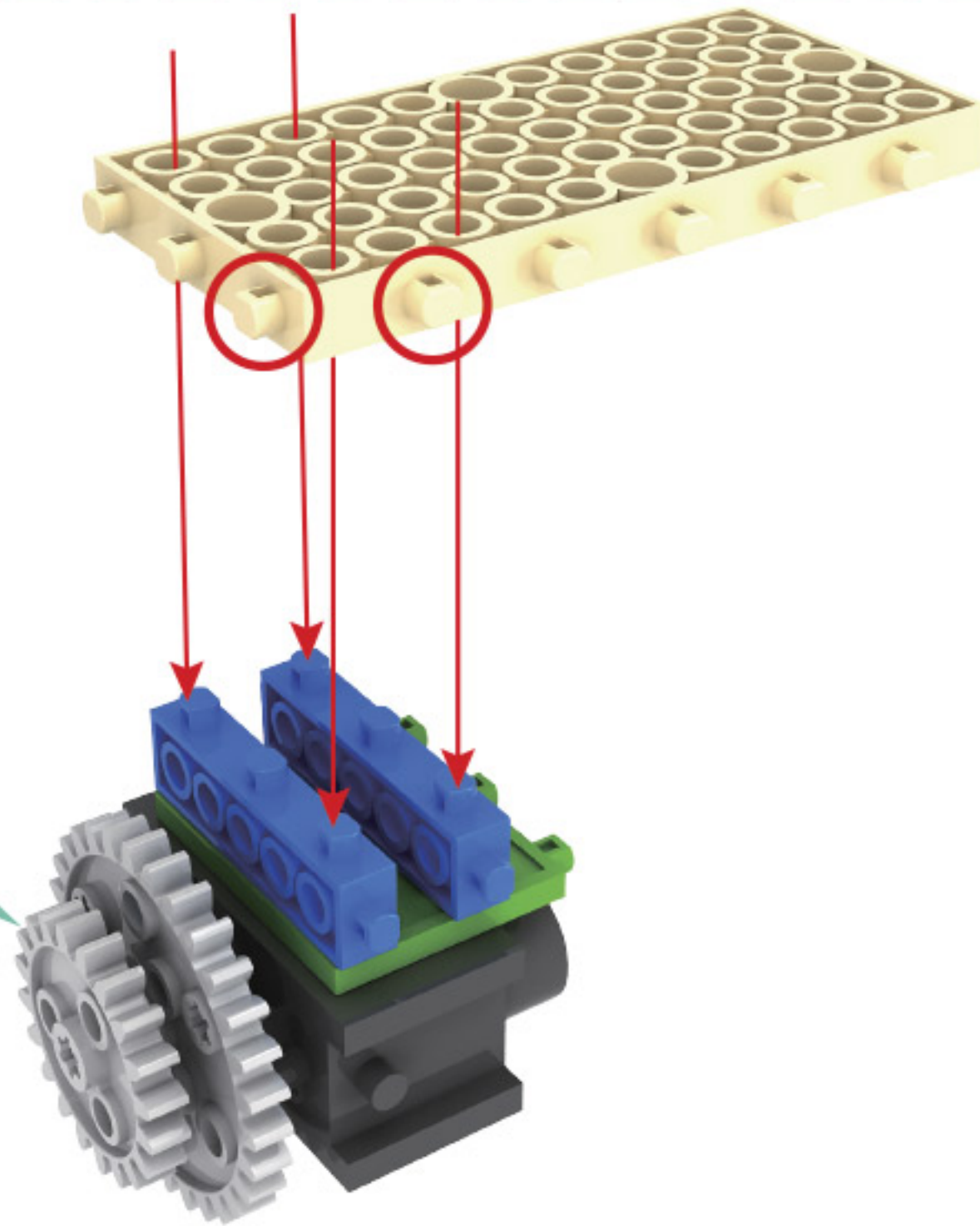
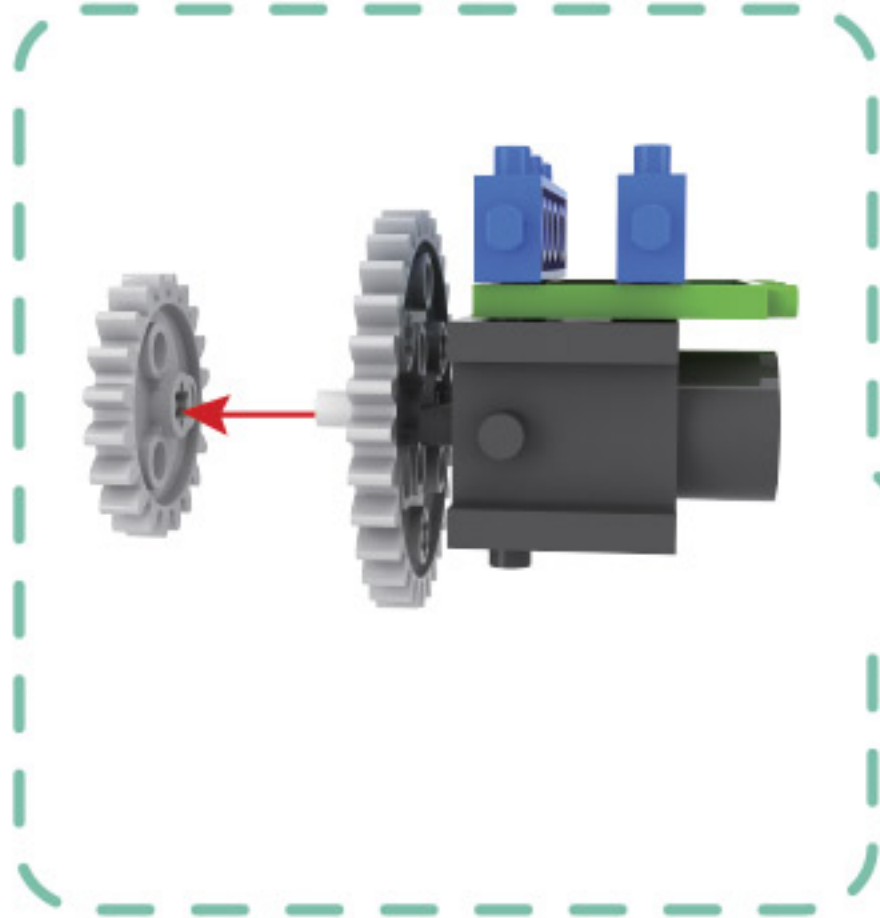
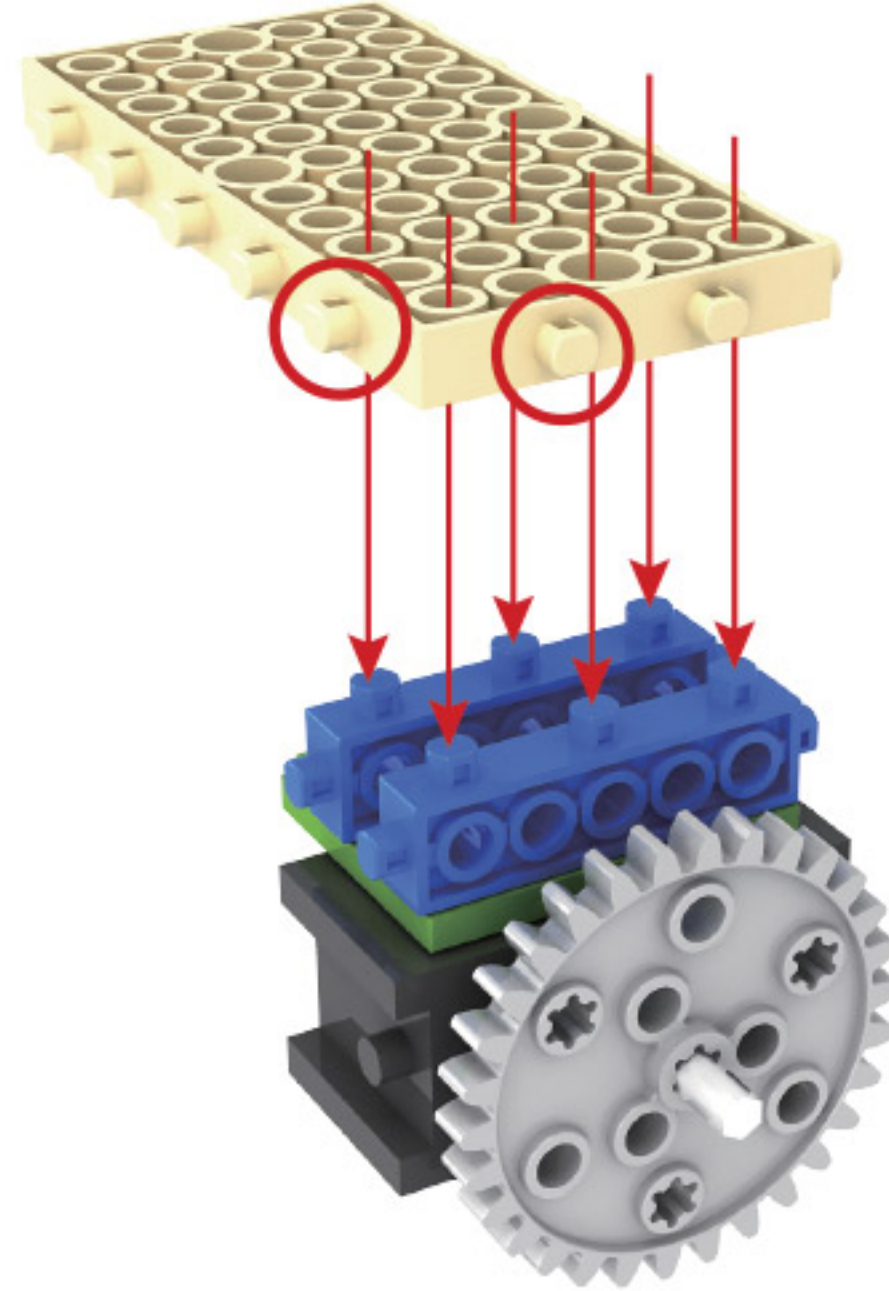

3

4

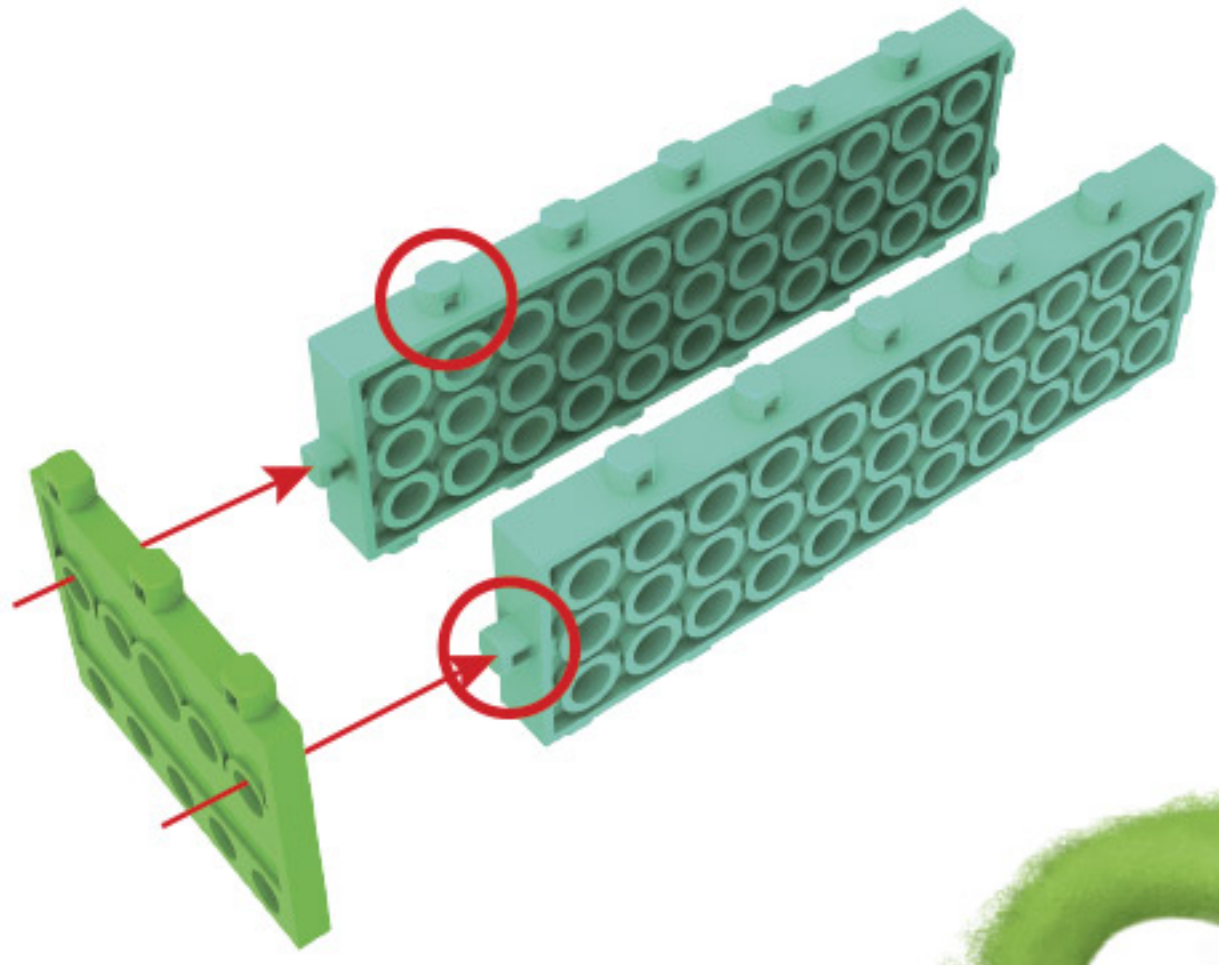

5

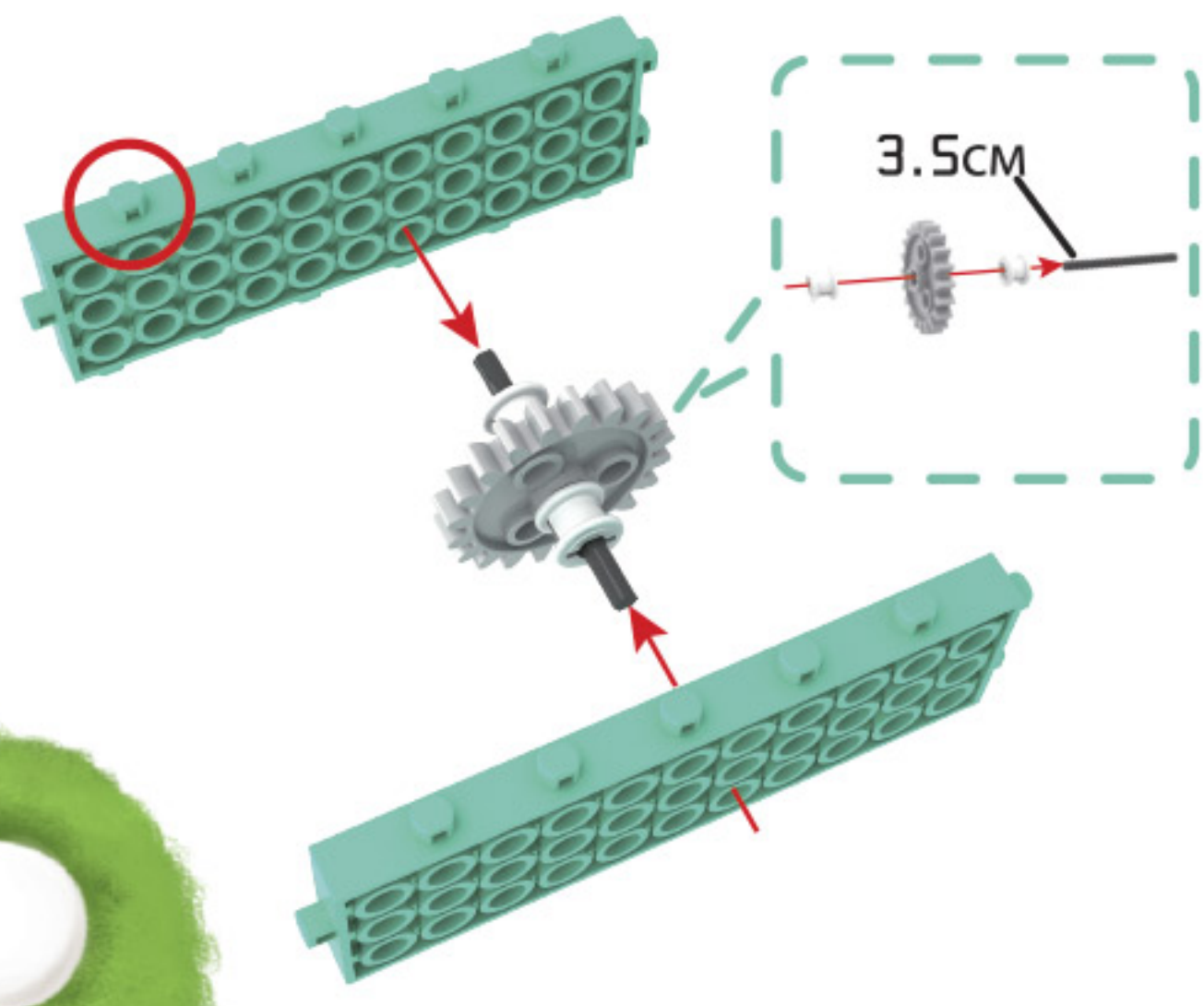

6

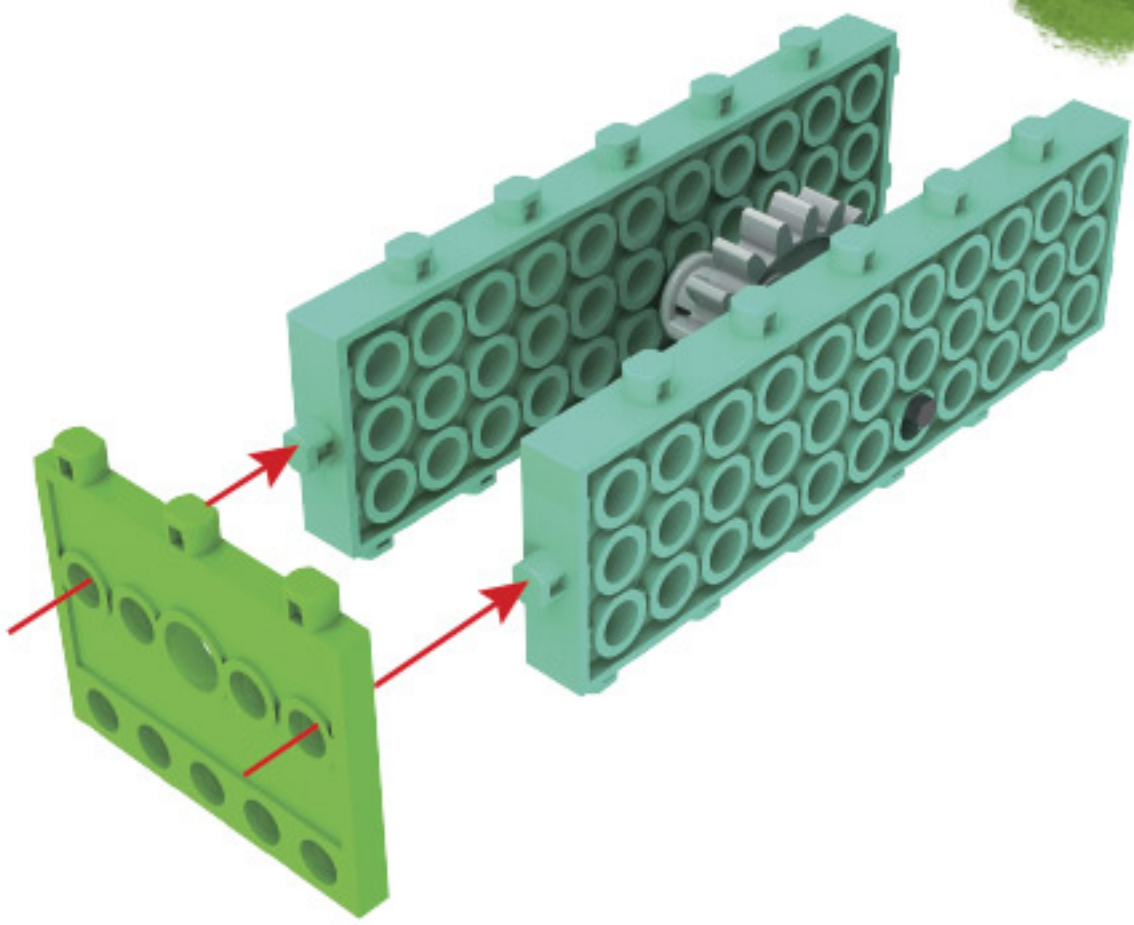

7

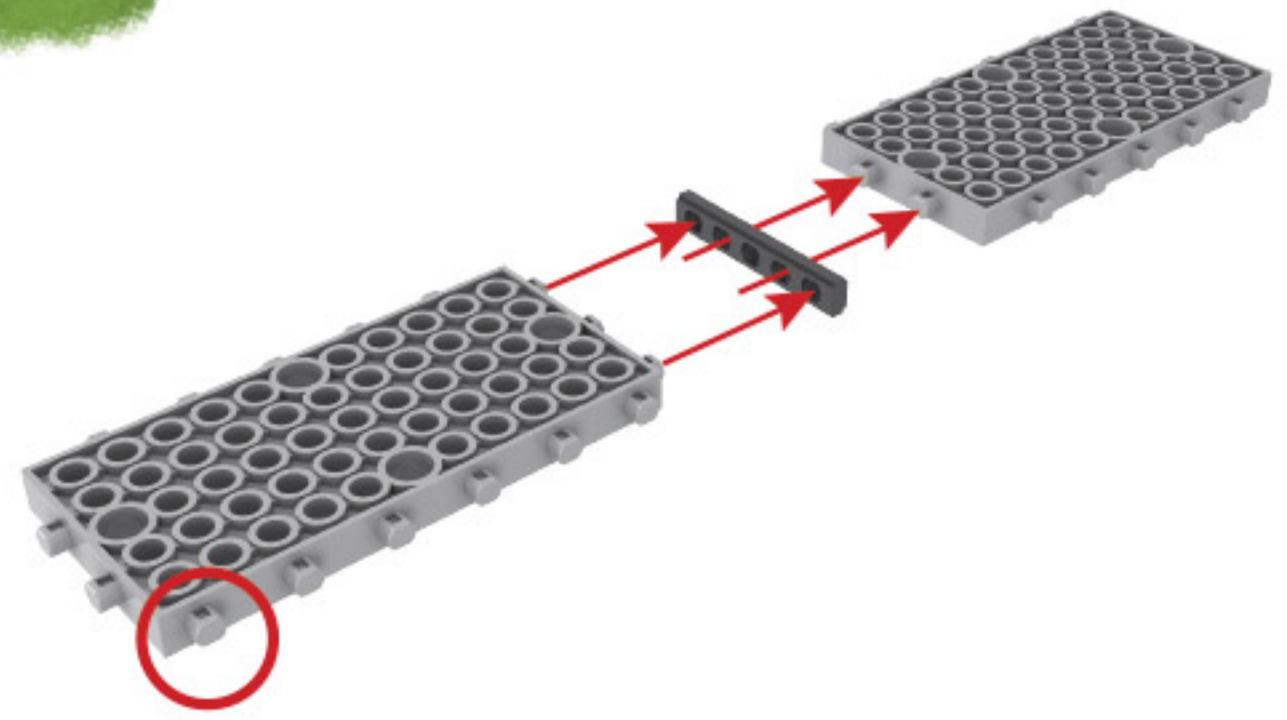

8

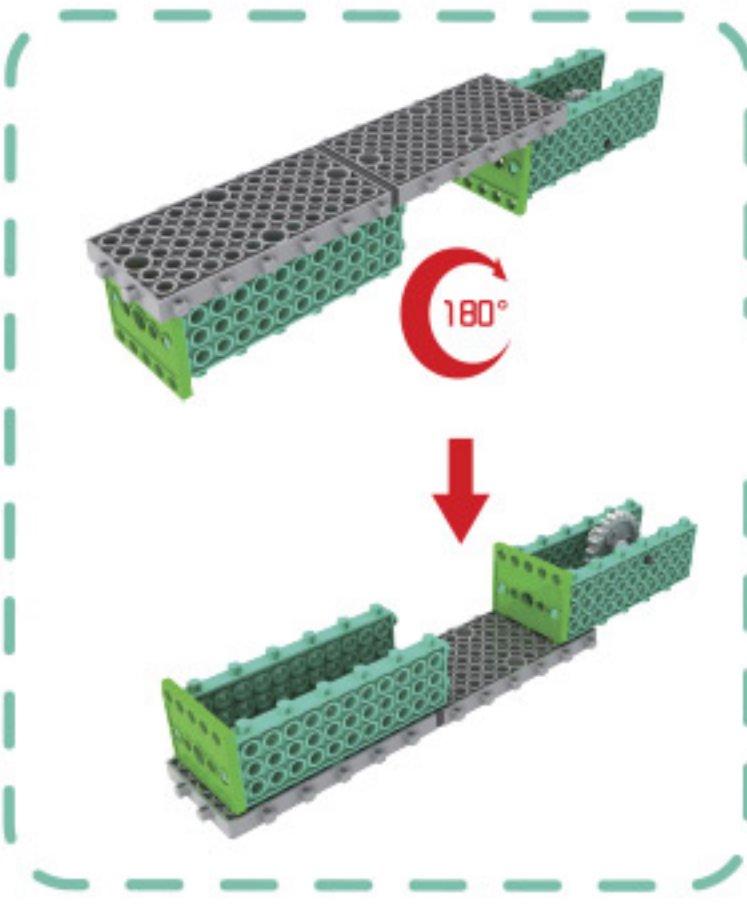
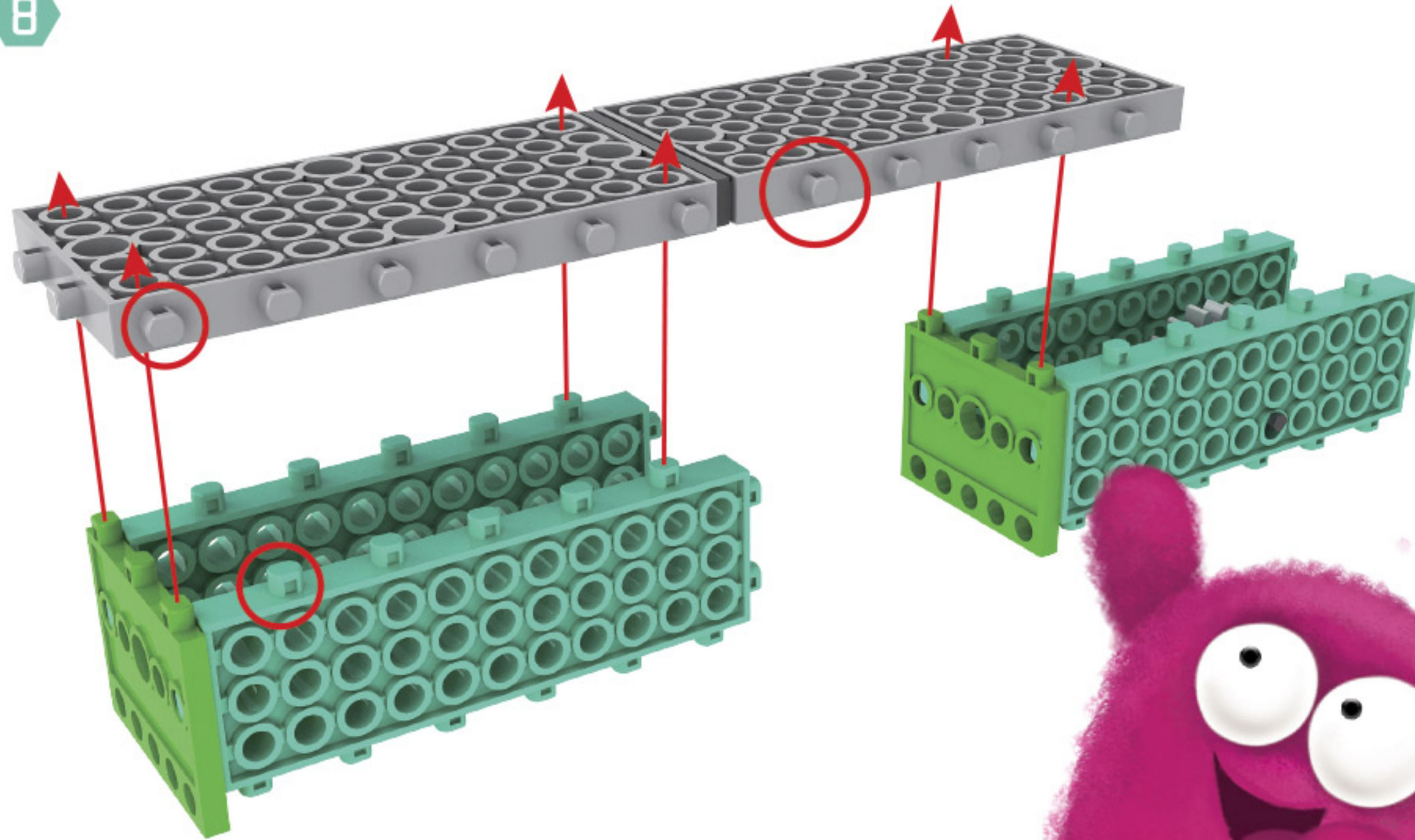

9

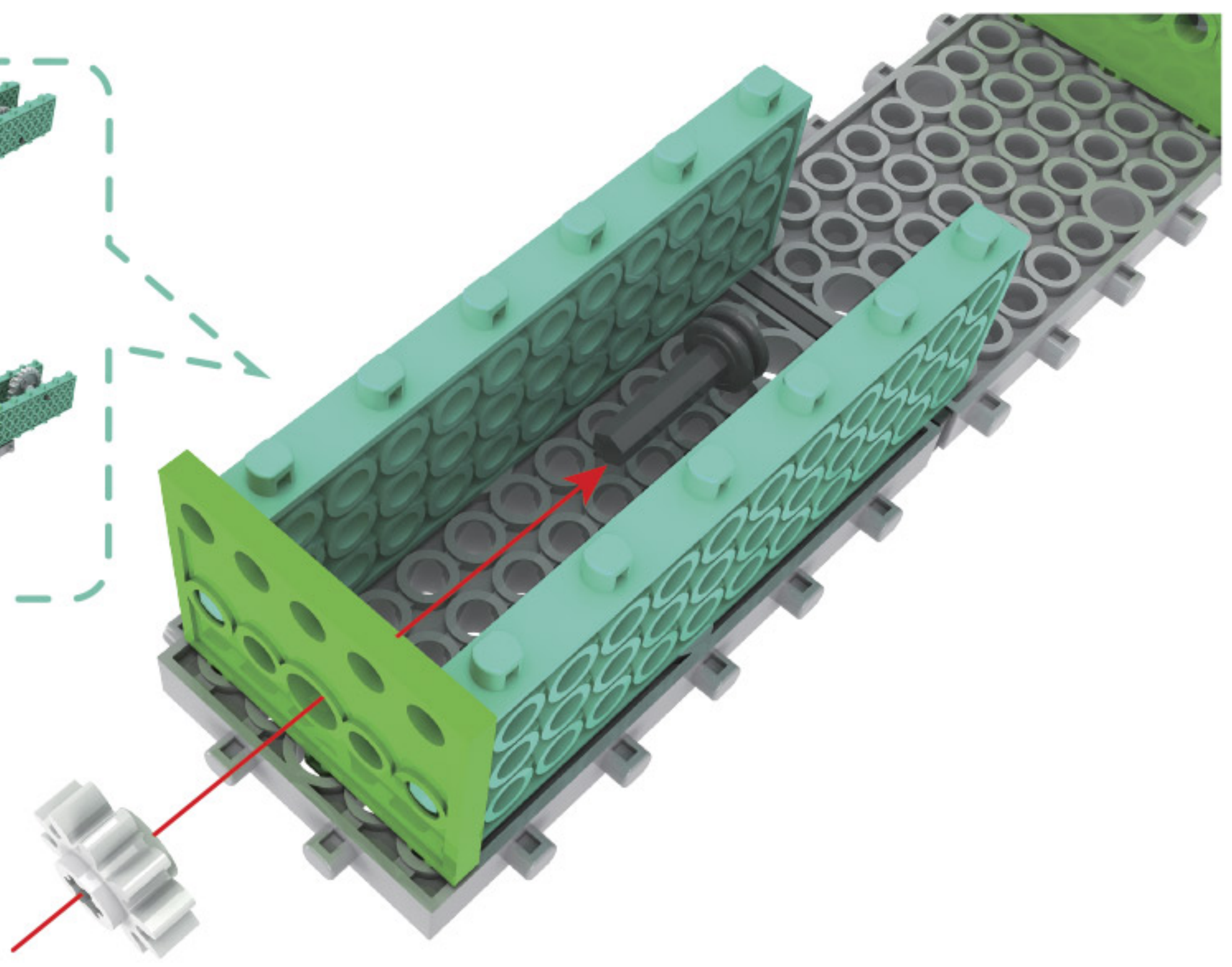

10

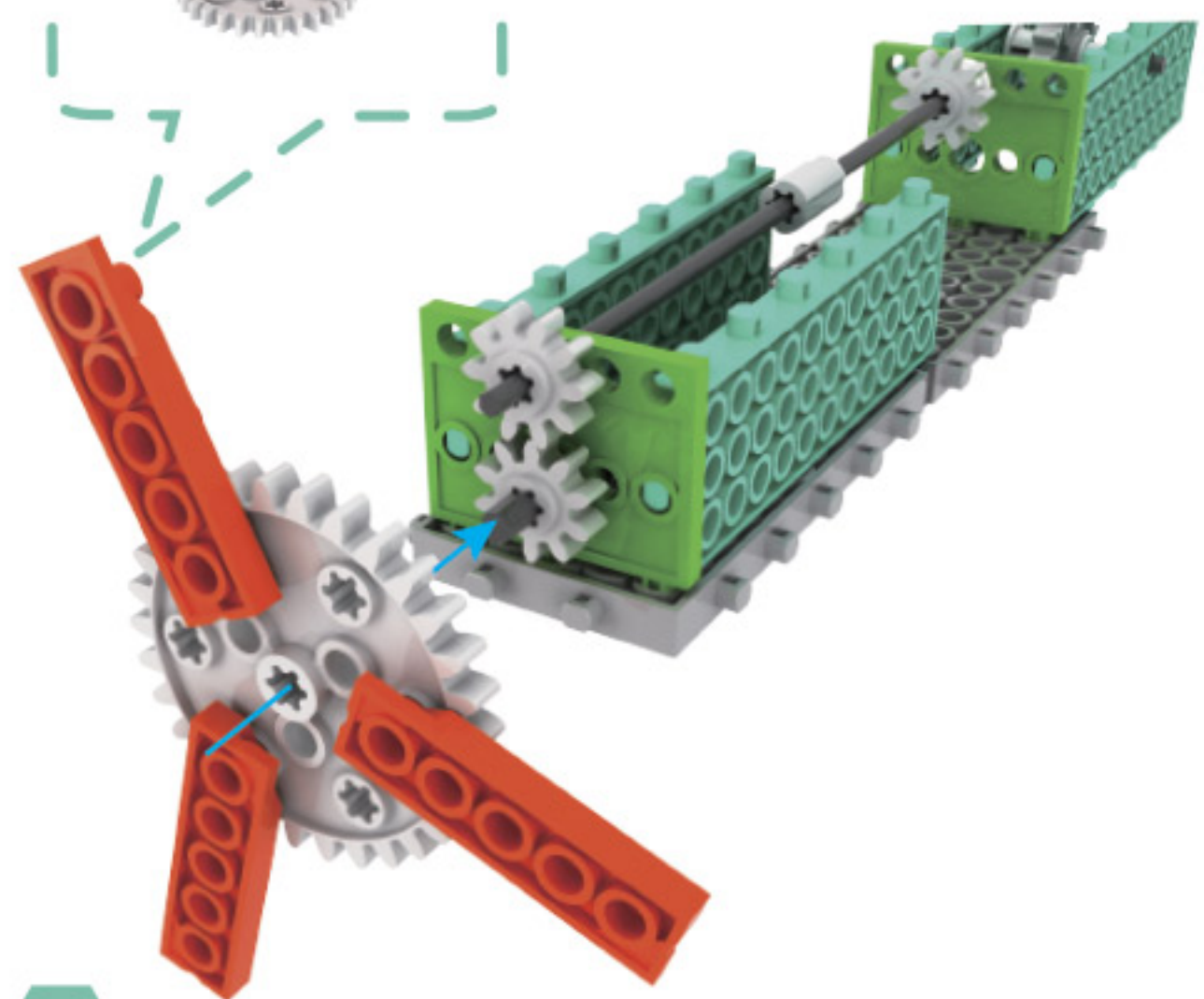
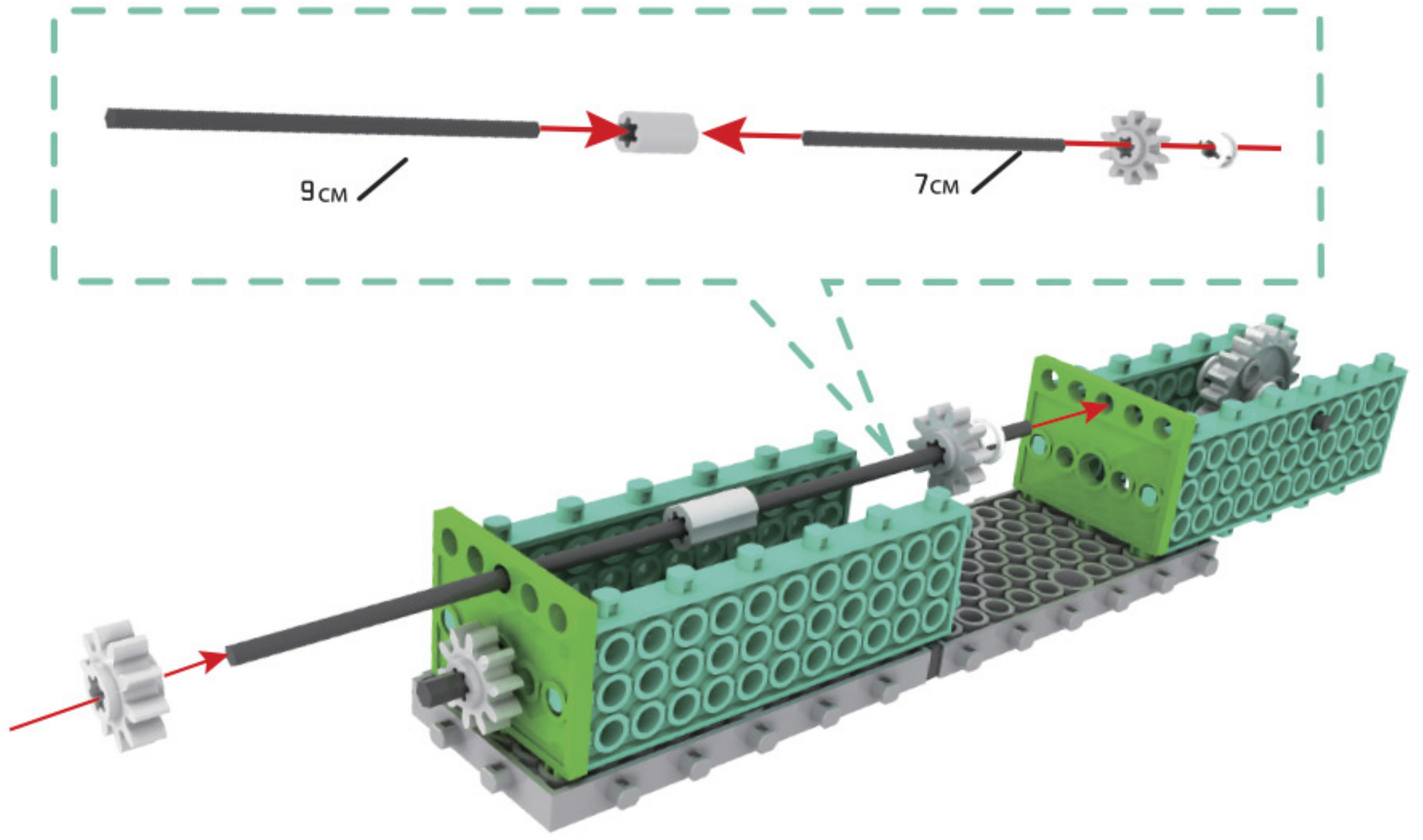

11

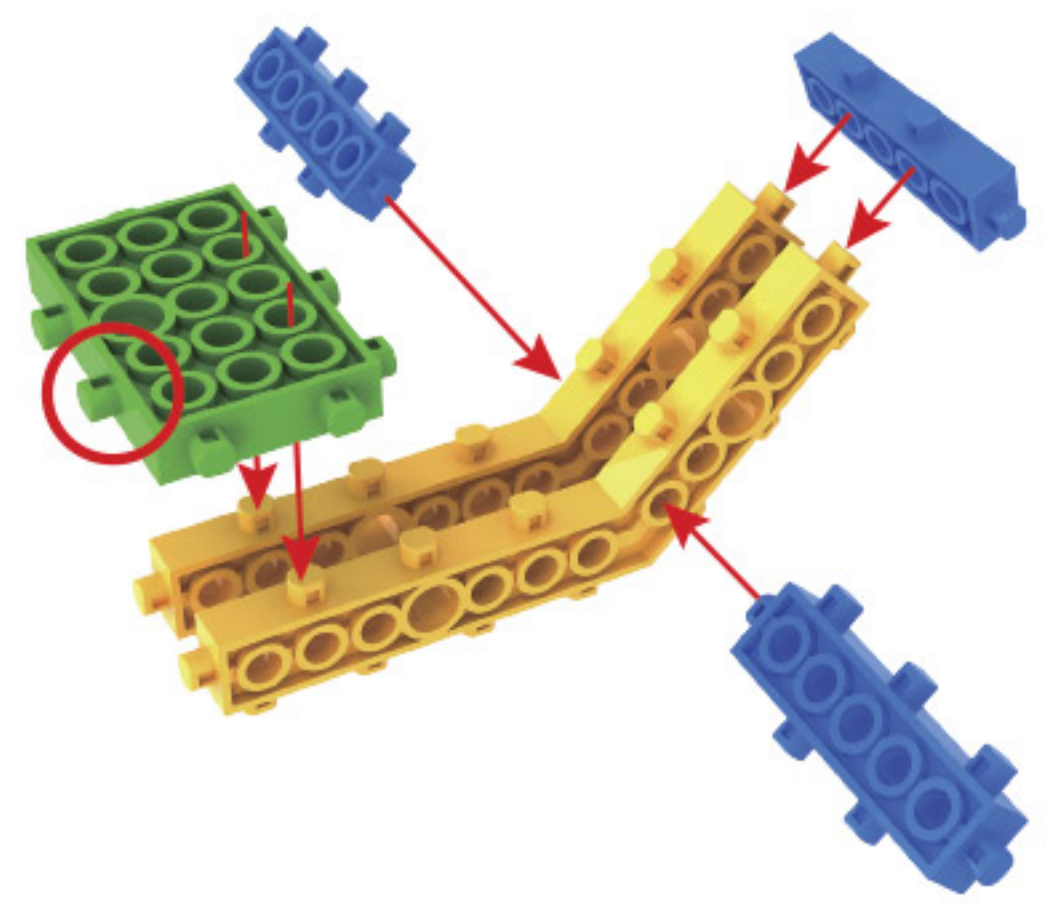

12

13

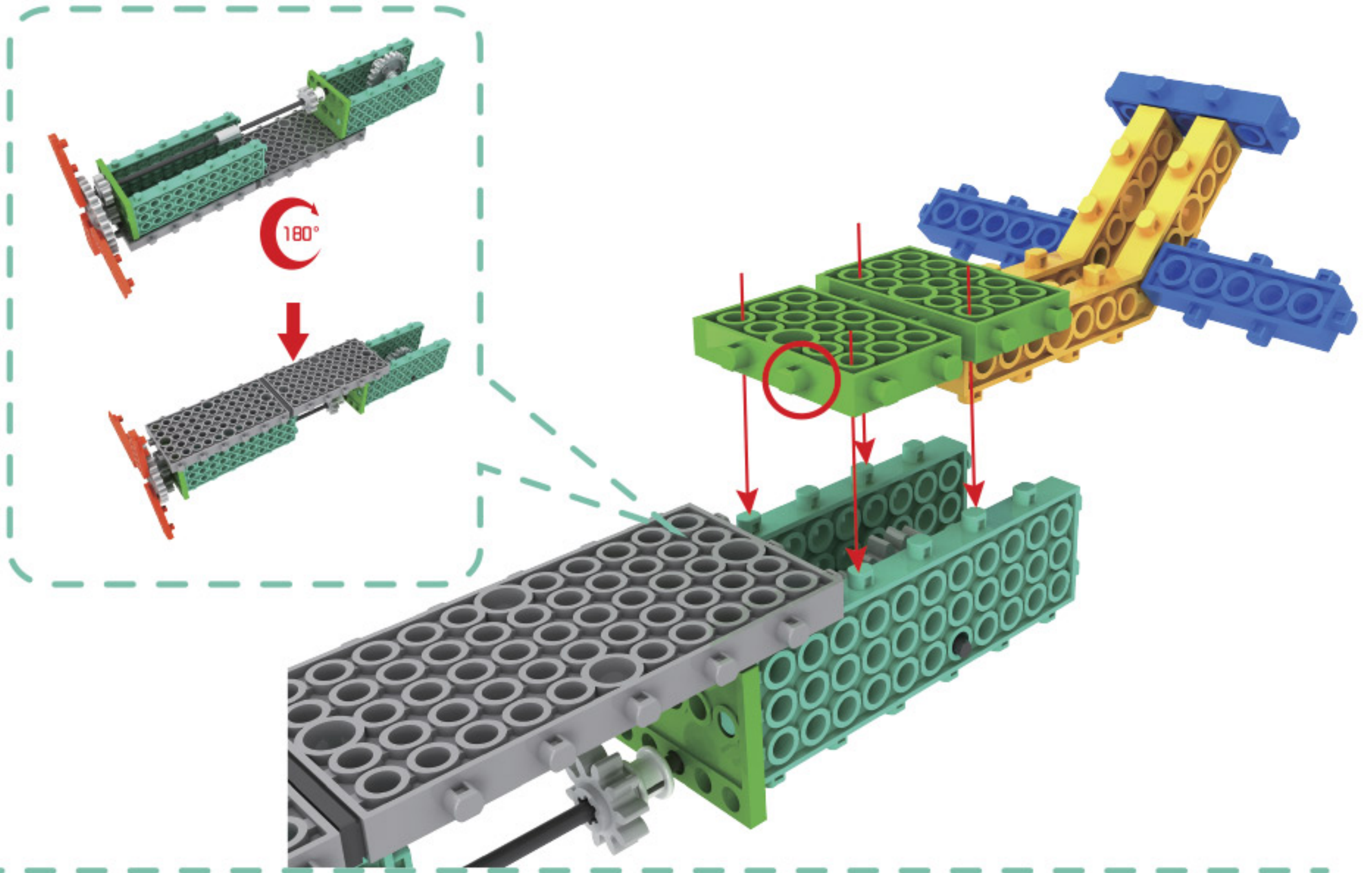

14

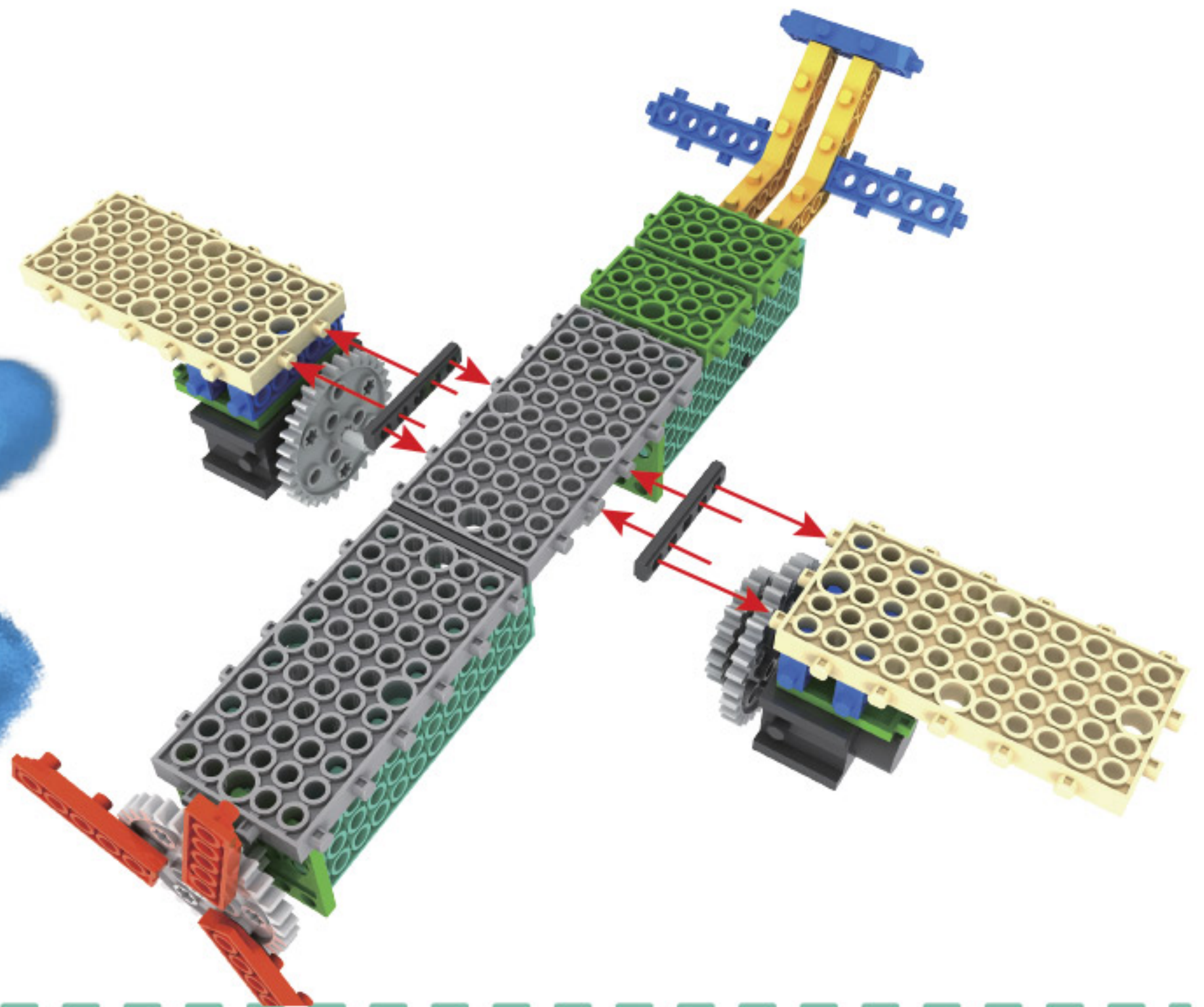

15

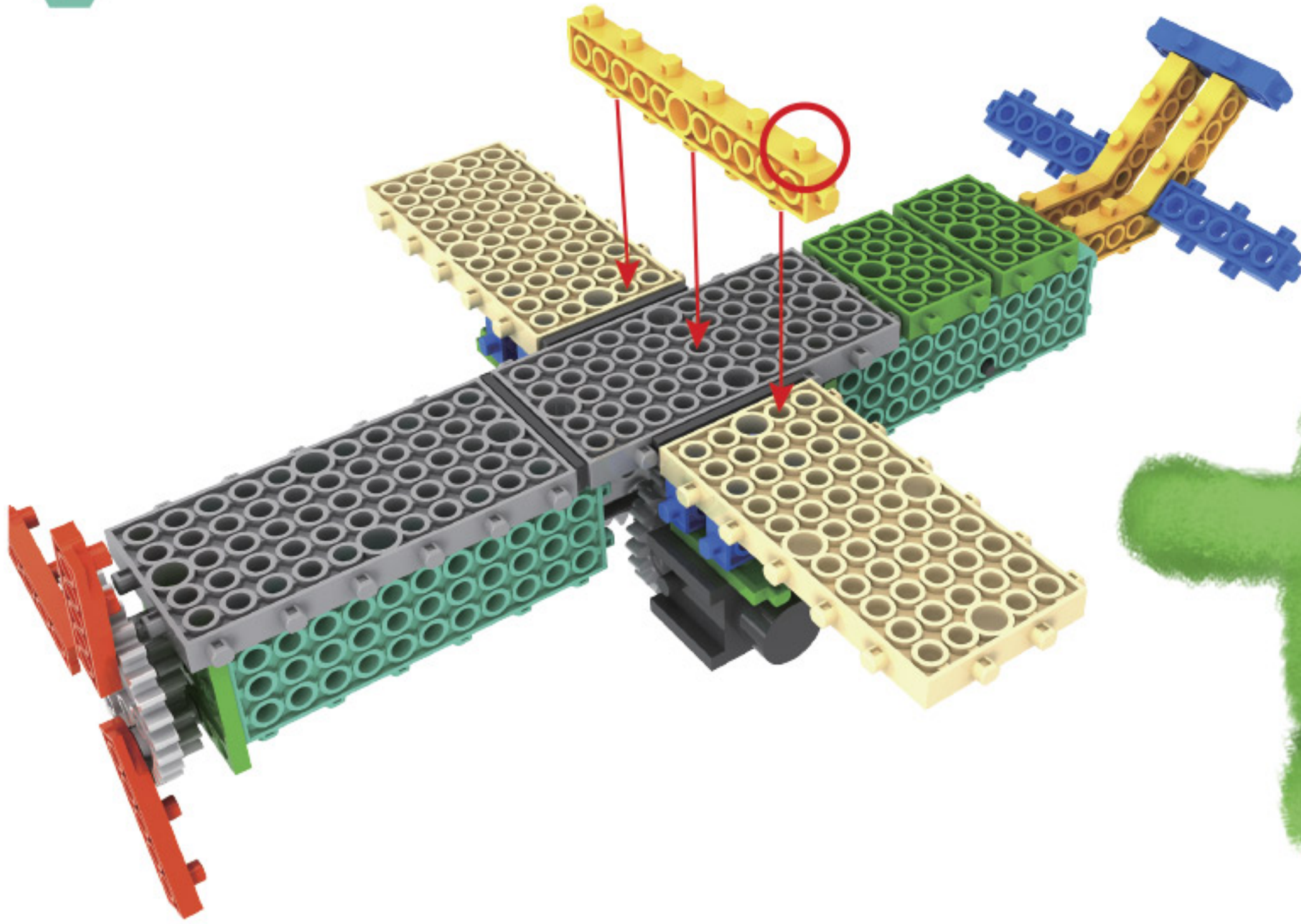

16

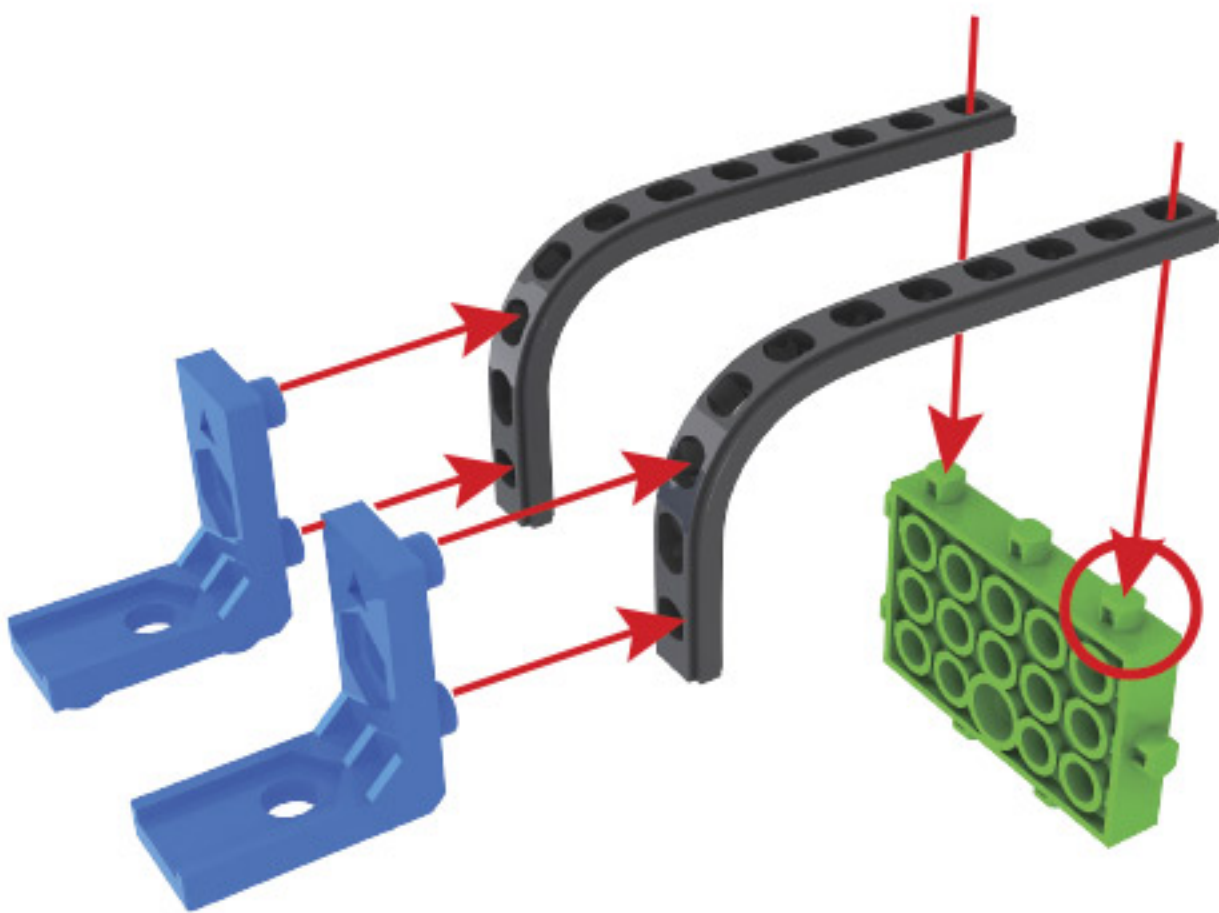

17

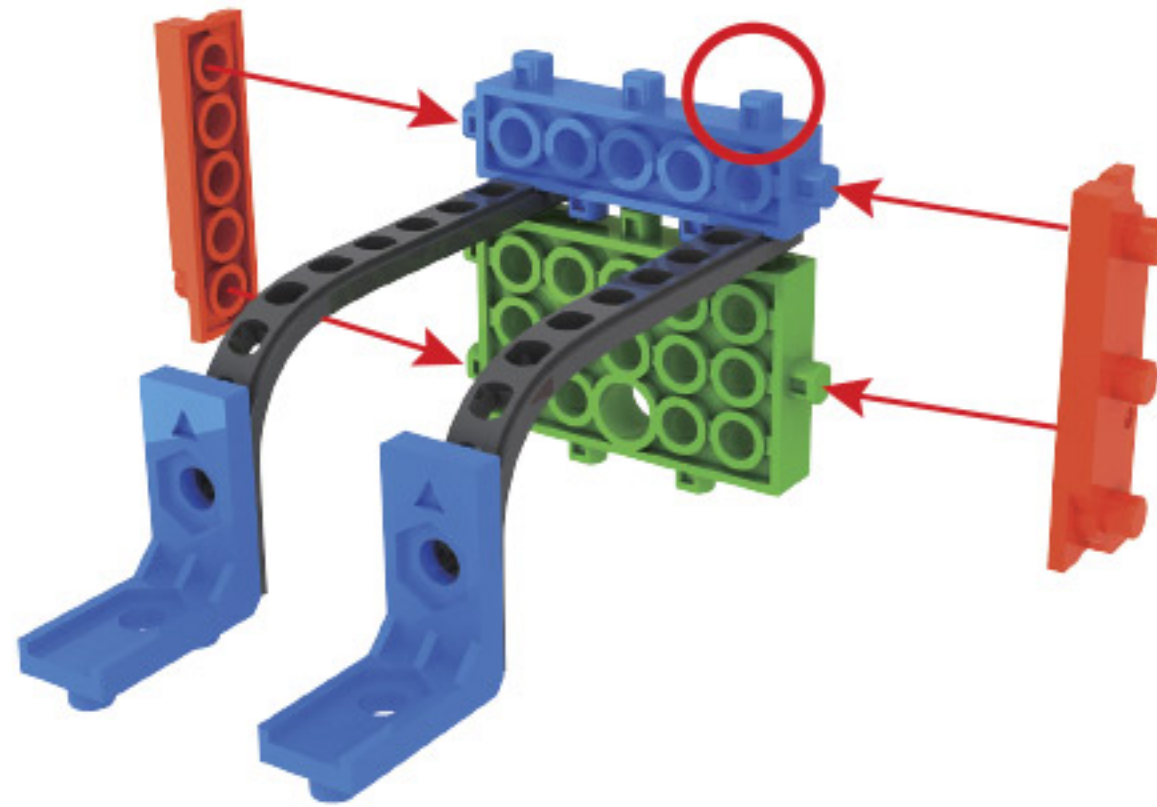

18

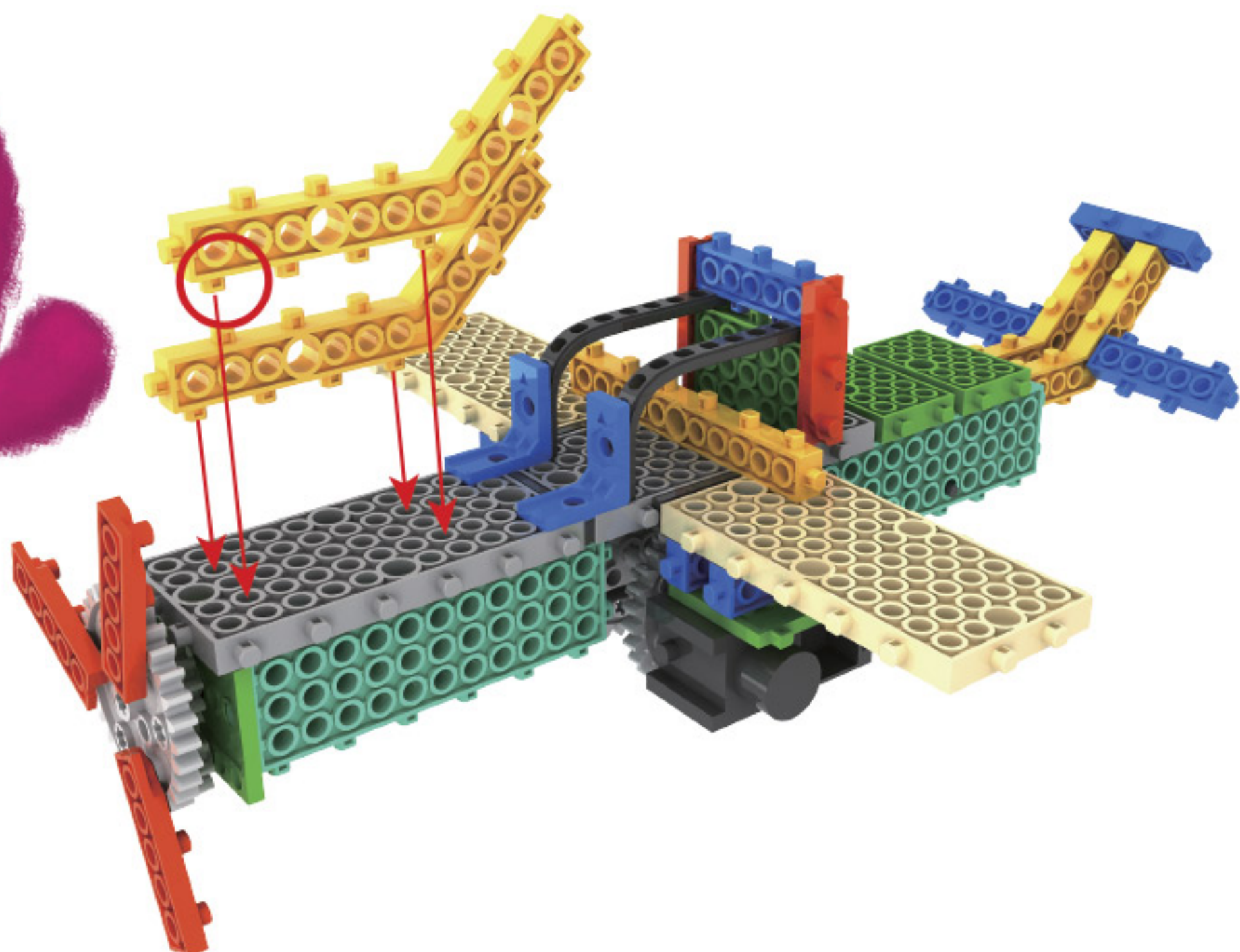
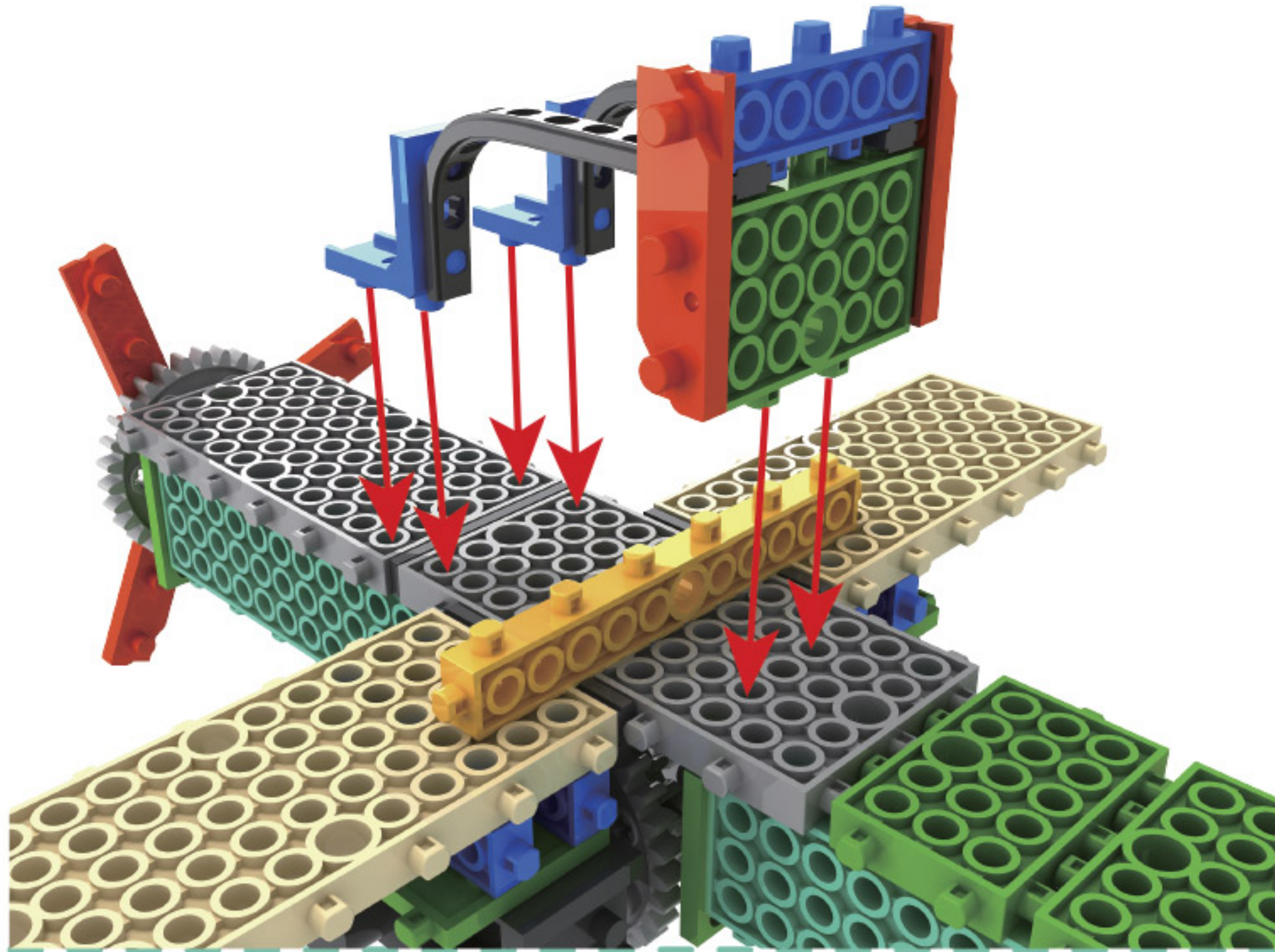

19

20

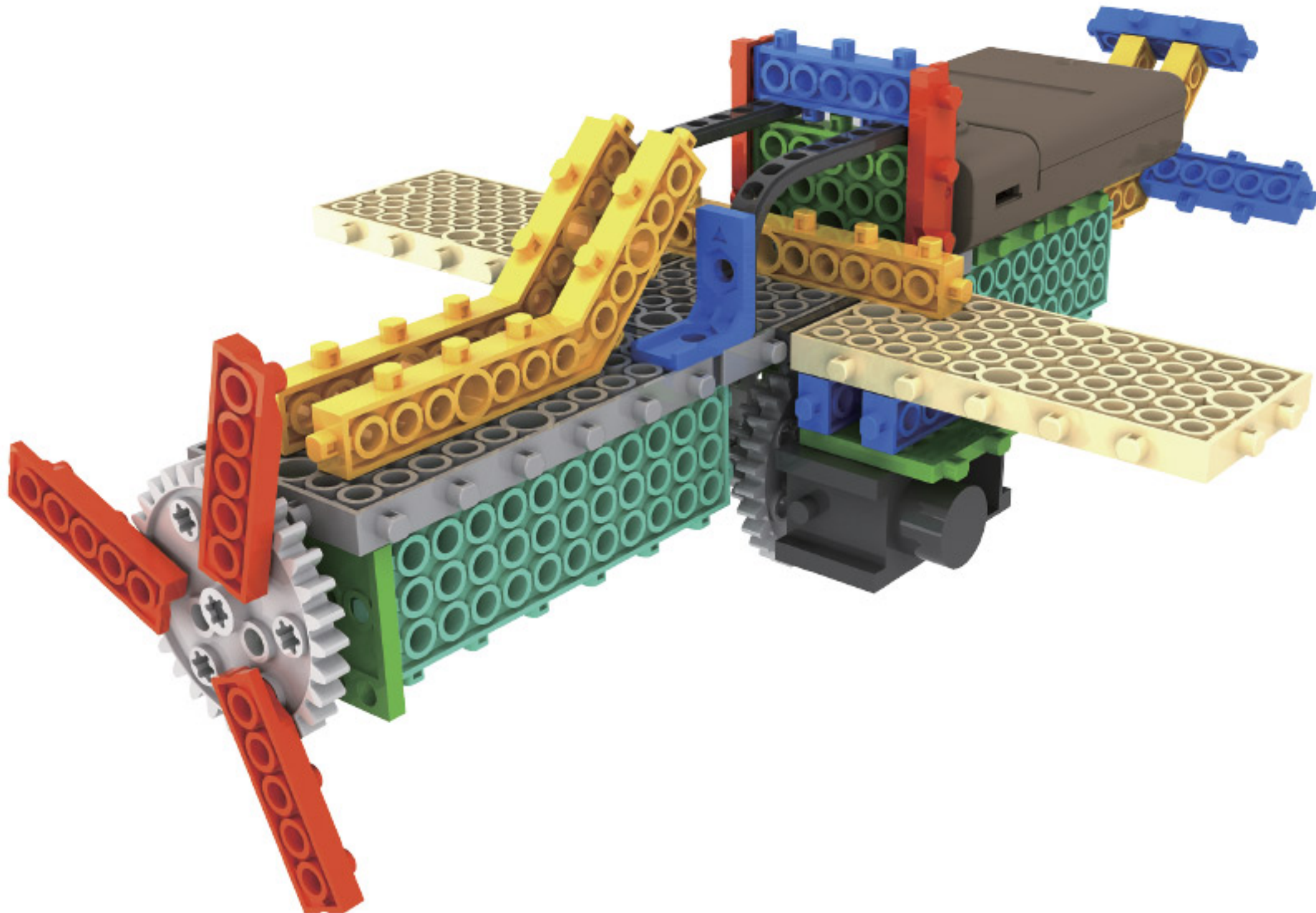
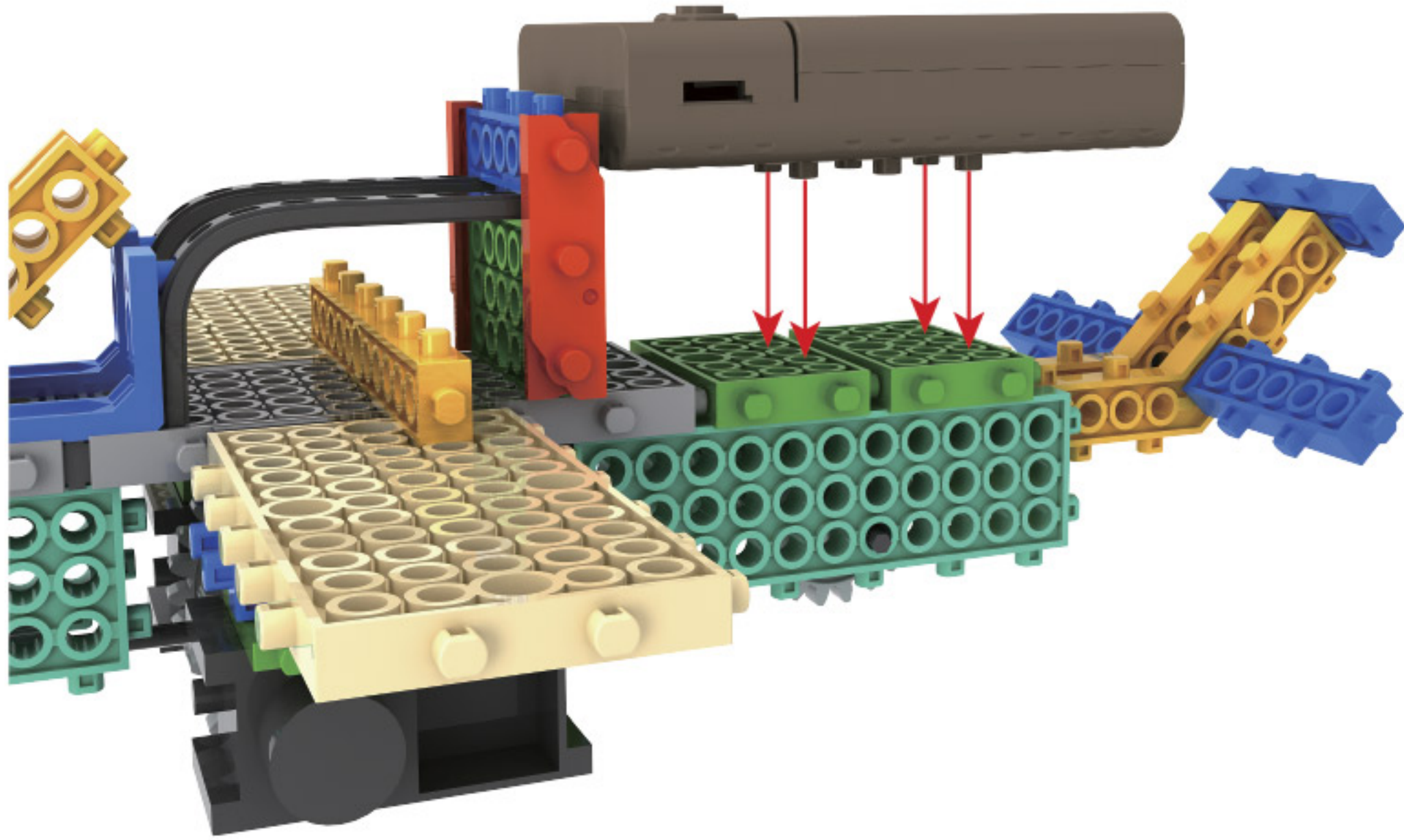

21

