

# Architect

3128





1x

1

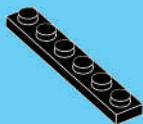

1x

2

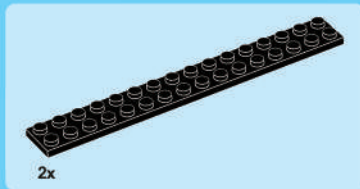
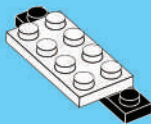

2x

3

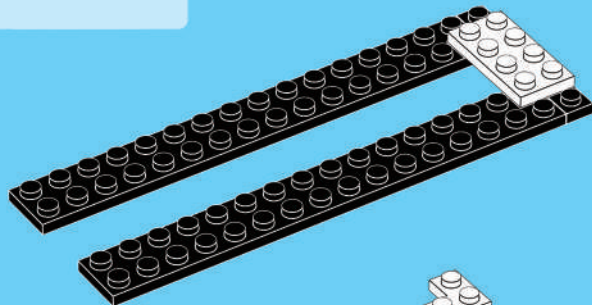

2x

4

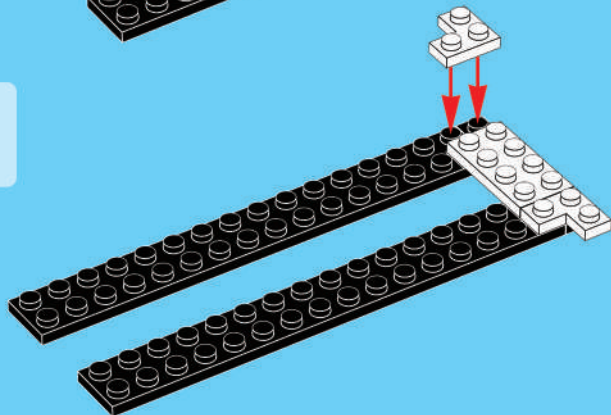

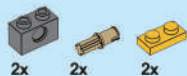

5

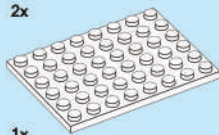
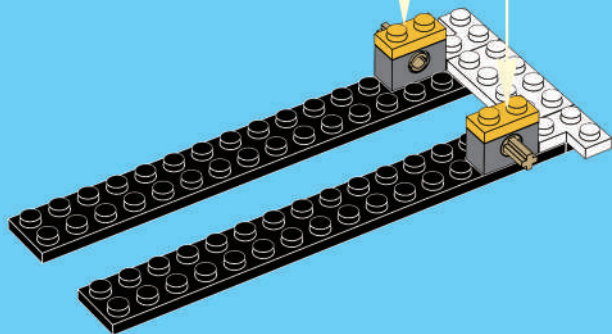
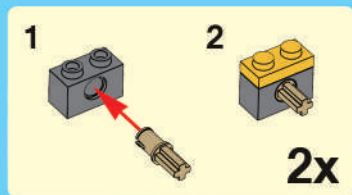

6

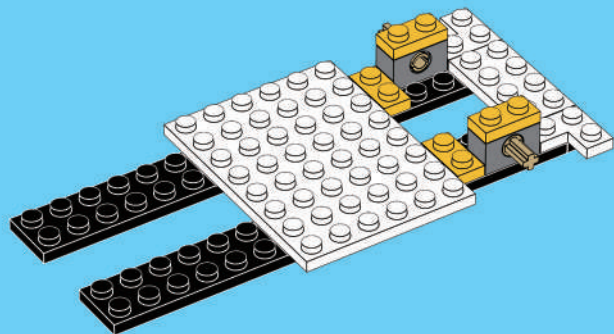

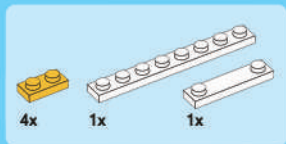

7

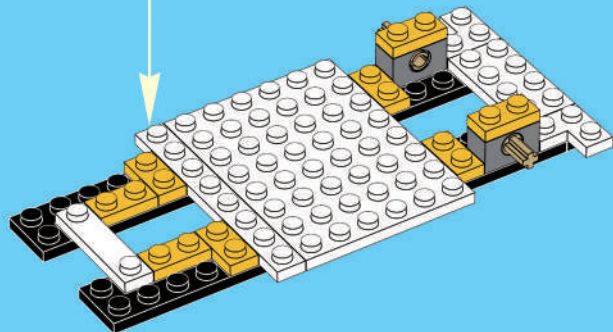
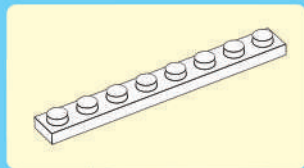

4

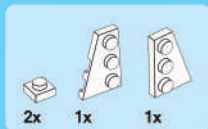

8

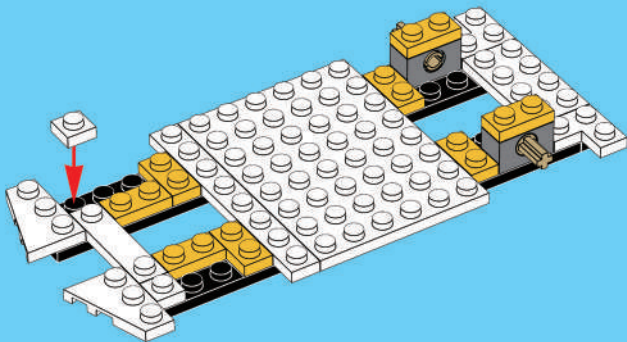

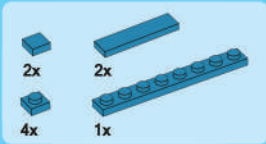

9

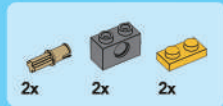
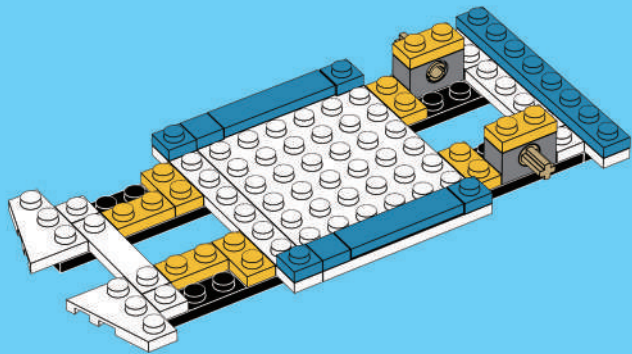

10

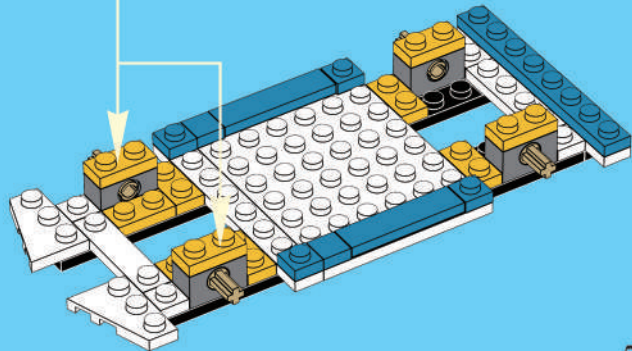
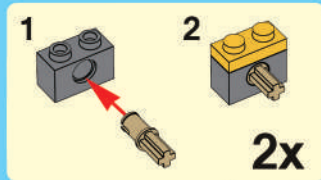

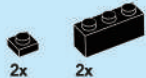

11

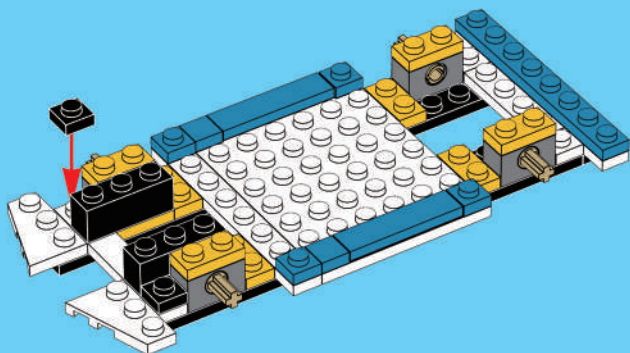

12

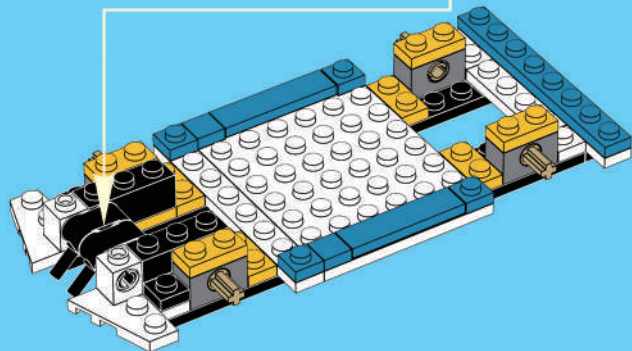
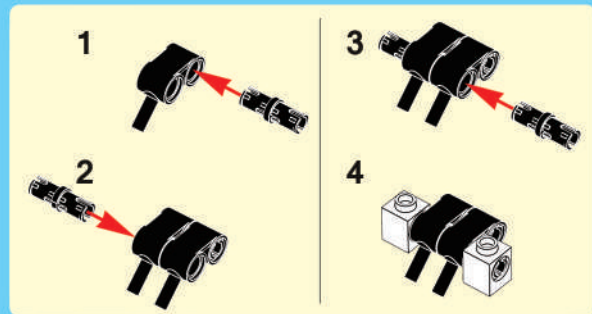



2x

# 13

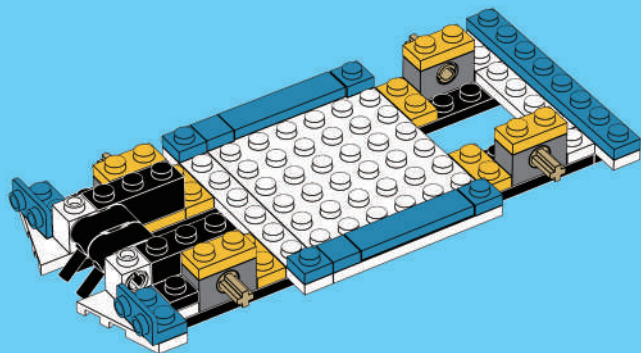

4x

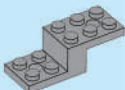

4x

# 14

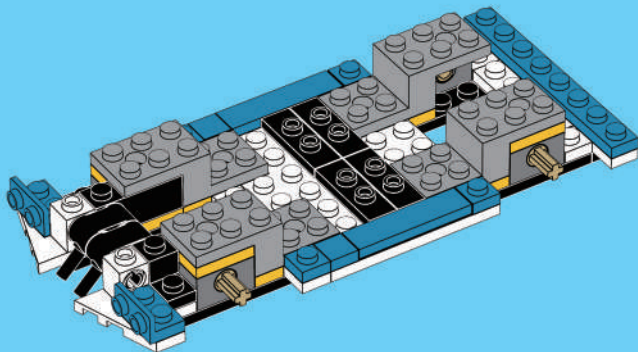

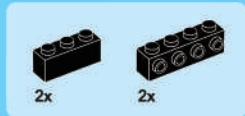

15

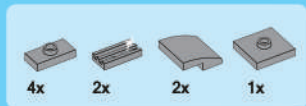
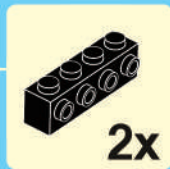
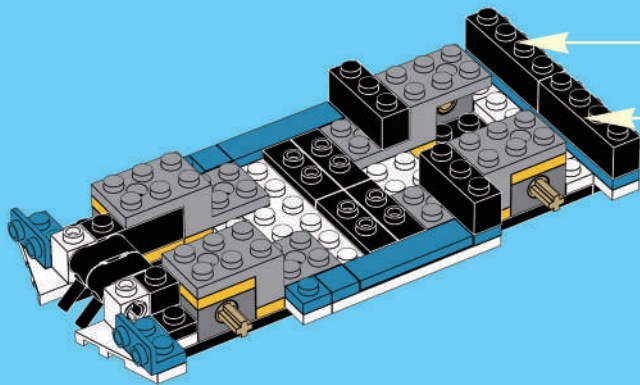

16

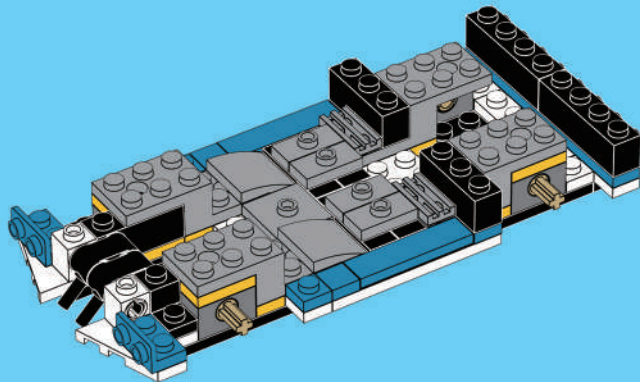





4x



1x

# 17

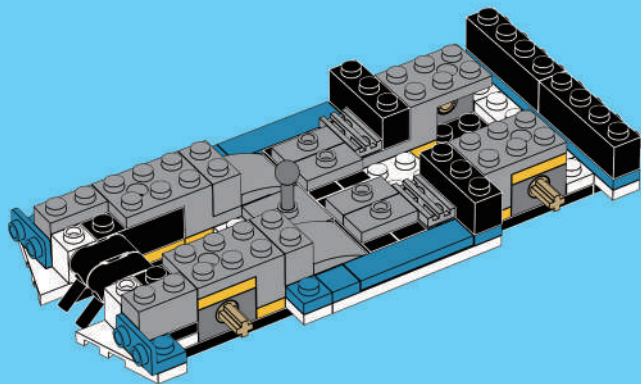

2x



2x

# 18

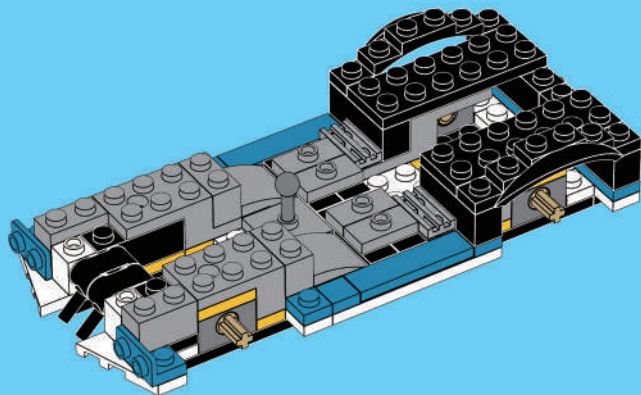



2x



2x

# 19

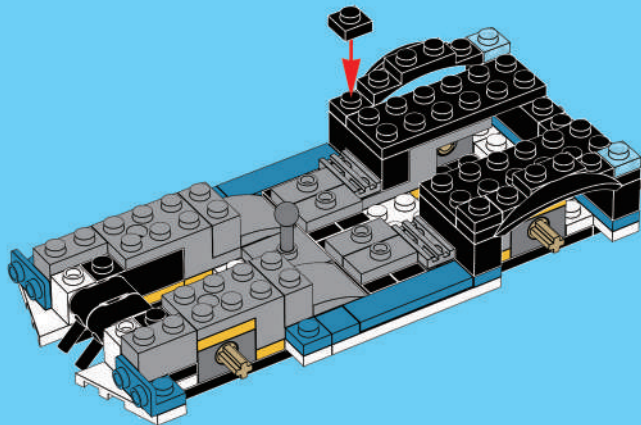

2x



2x



2x



2x

# 20

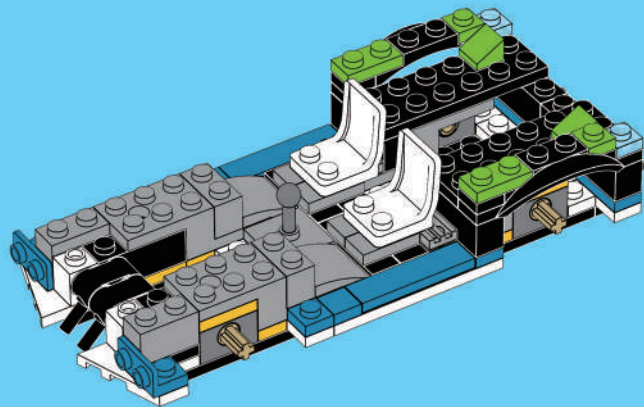

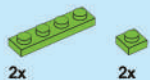

2x

2x

# 21

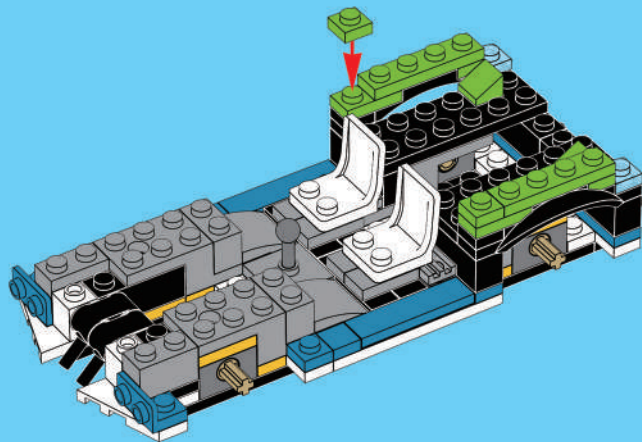

1x

# 22

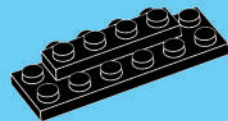

1x



2x

# 23

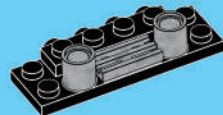



2x

24

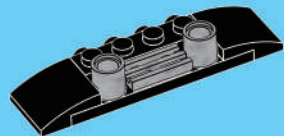

2x



1x

26

25

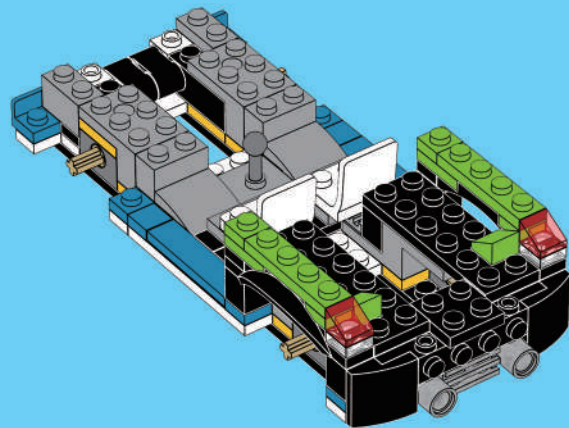
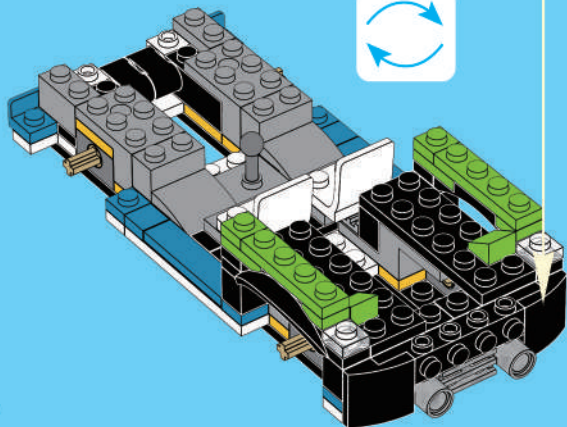



2x



2x



1x

# 27

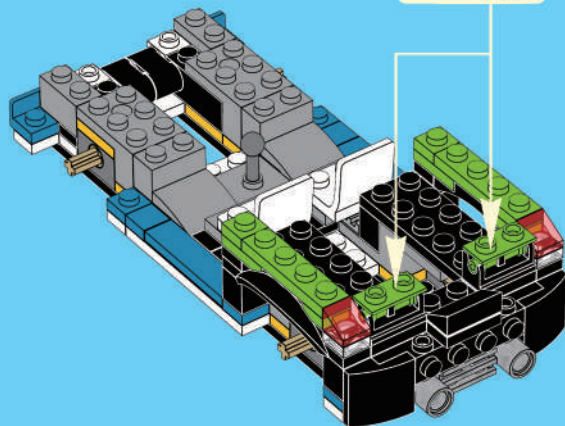
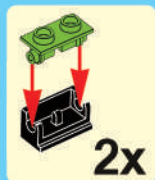

2x



2x



2x

# 28

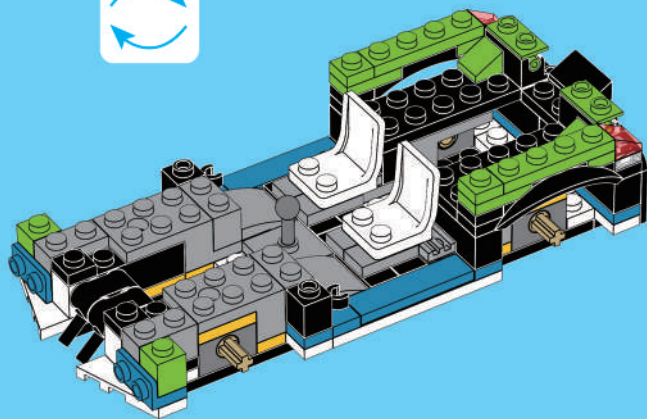



29

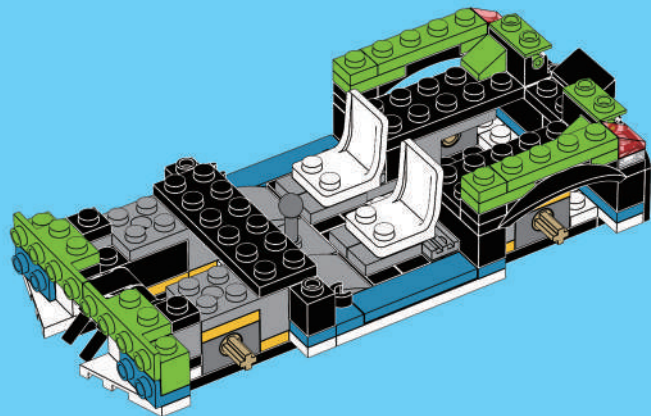

30

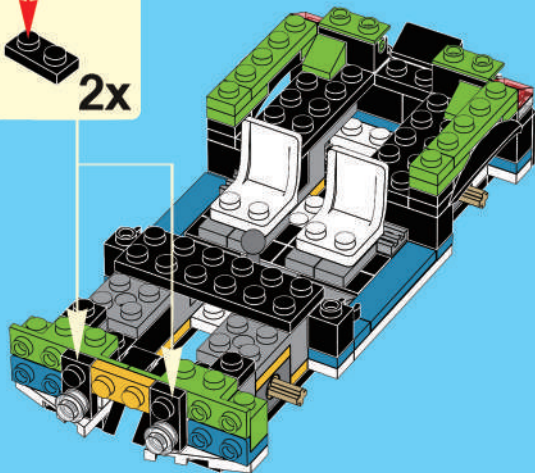
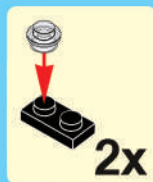



2x



1x

# 31

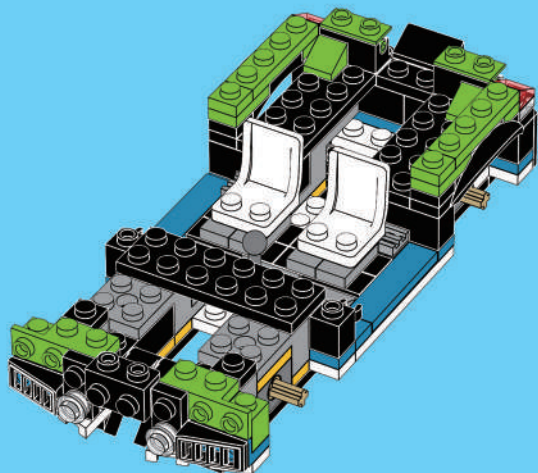

2x



1x



2x

# 32

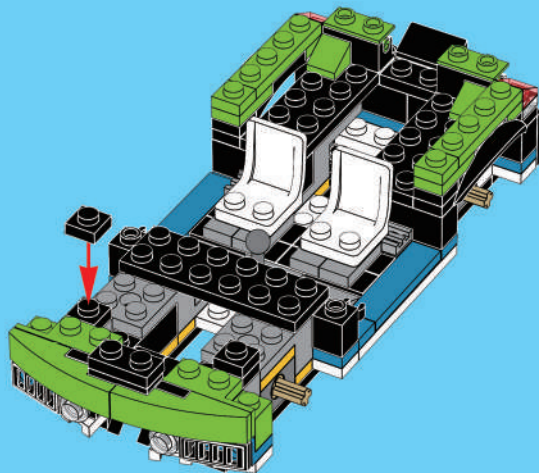

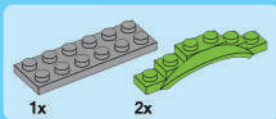

33

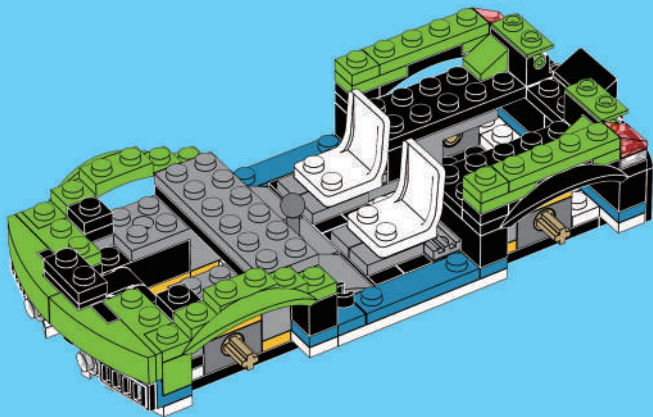

34

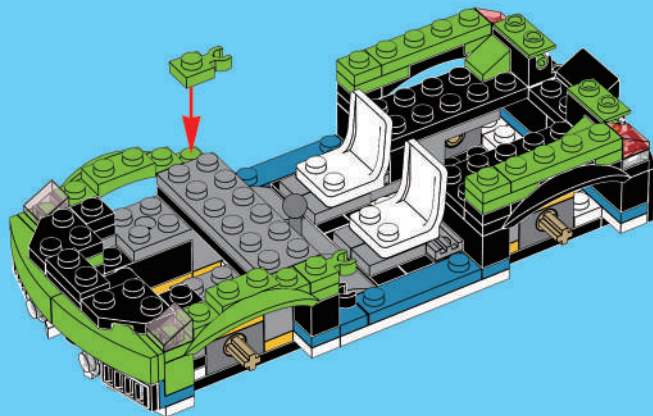



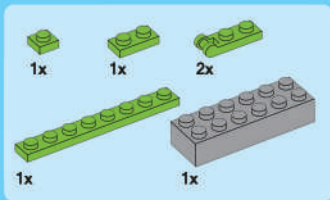

35

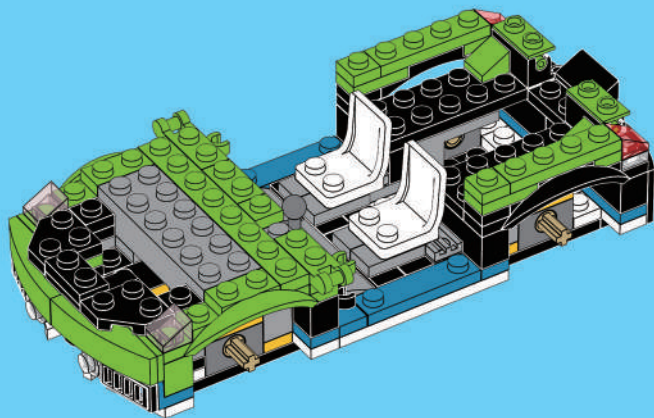



1x



1x



1x

# 36

1



2

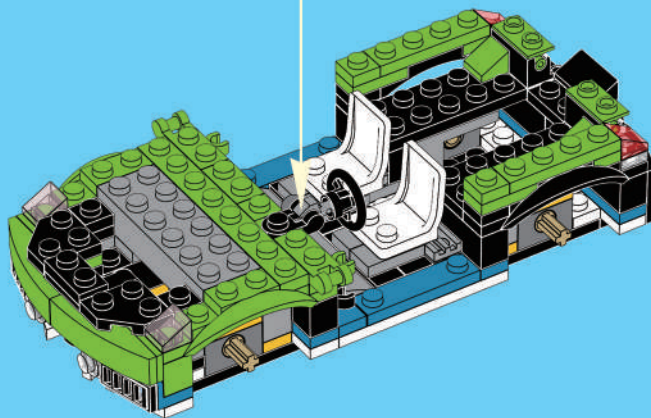

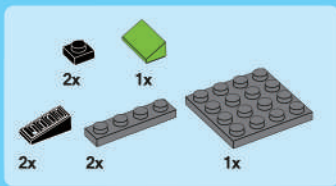

37

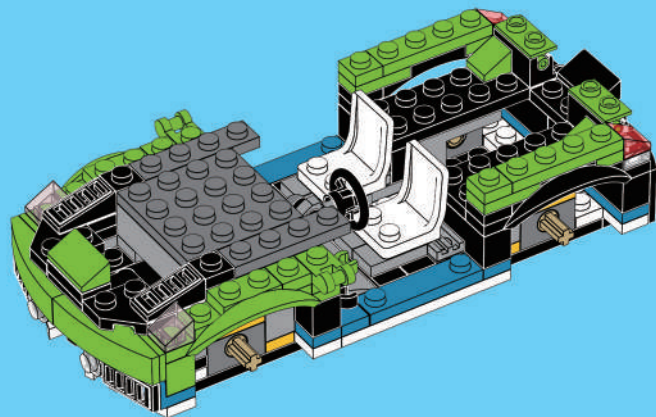



38

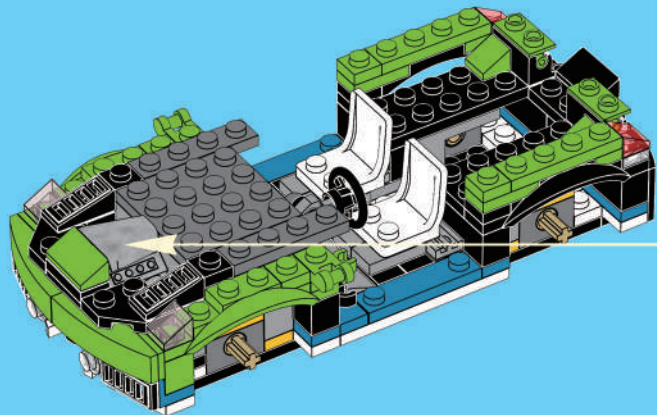
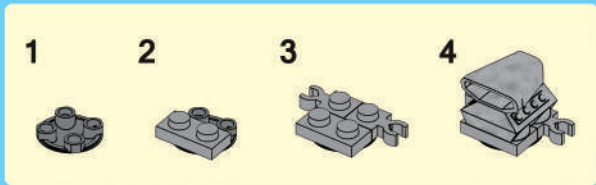



2x

2x

2x

# 39

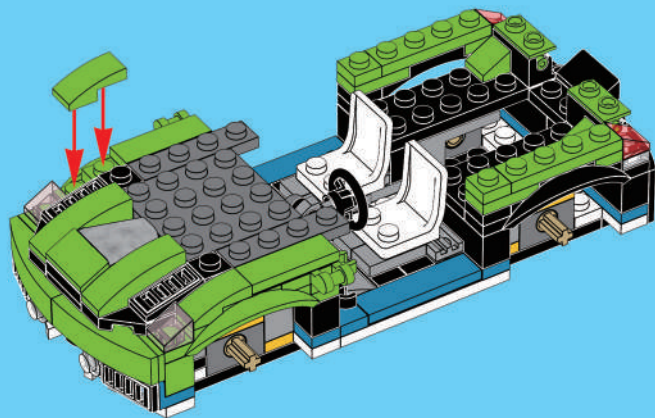

1x

# 40



1x



1x

# 41



1x

# 42

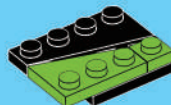



1x



1x

# 43

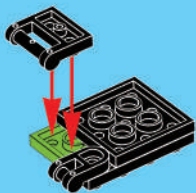

1x

# 44

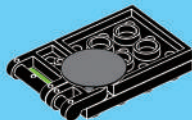

# 45

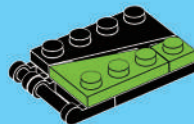

# 46

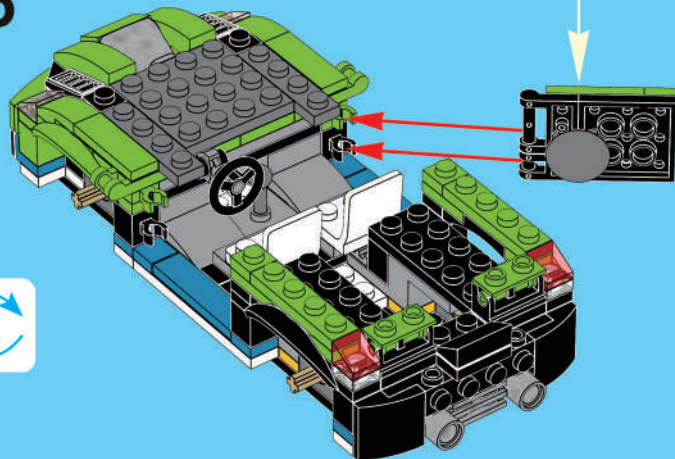



1x

47



1x



1x

48

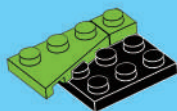

1x

49

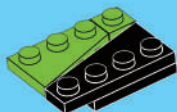

1x



1x

50

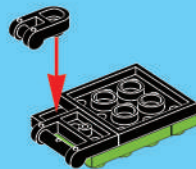

1x

51

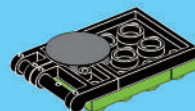

52

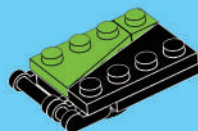

53

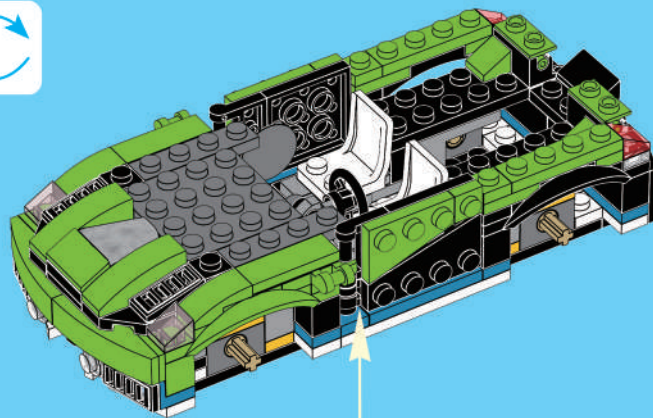





2x



2x

# 54

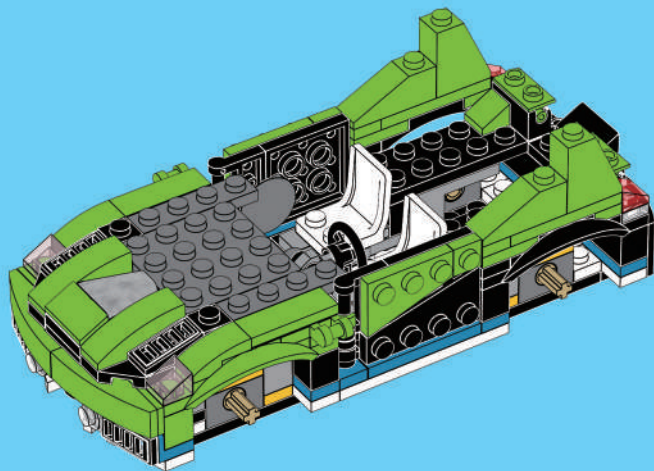

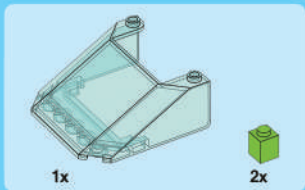

55

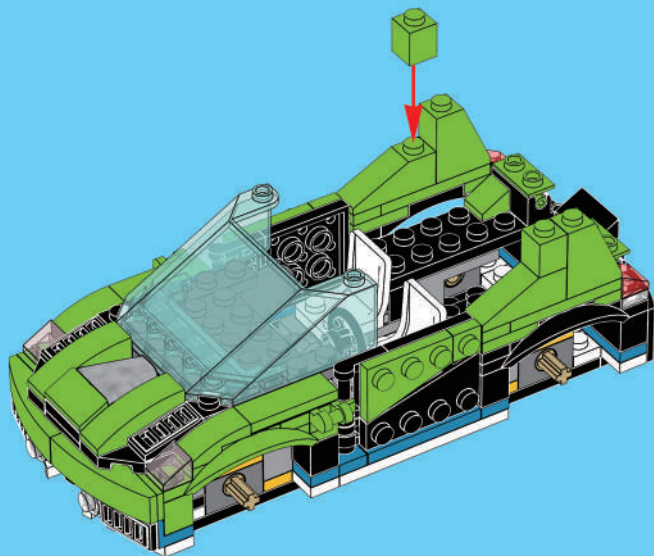



2x

56

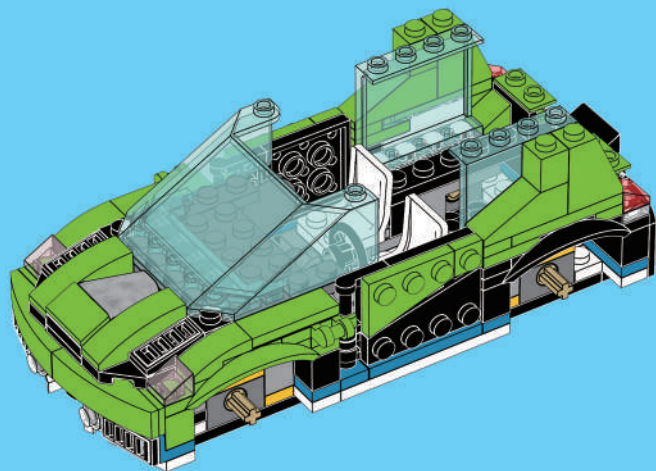



2x

57

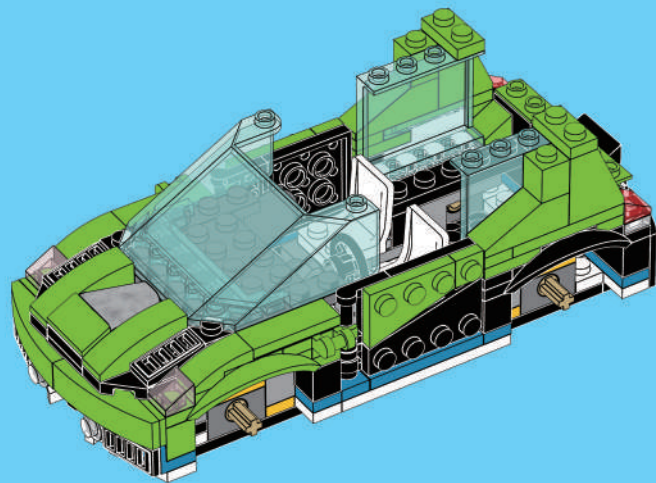



2x

58

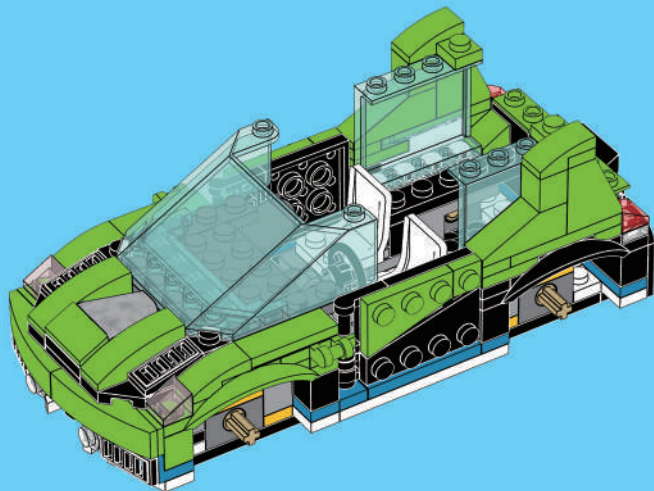



1x

59

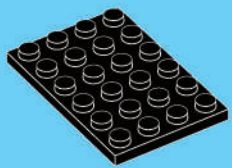

2x

60

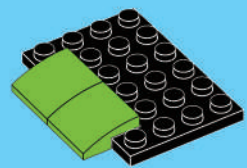

1x



1x



1x



1x

61

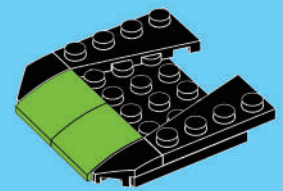

1x

62

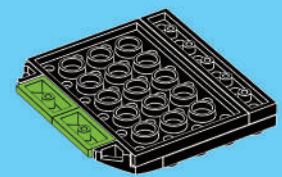

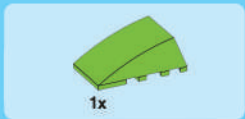

63

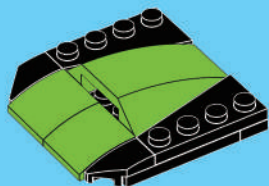

64

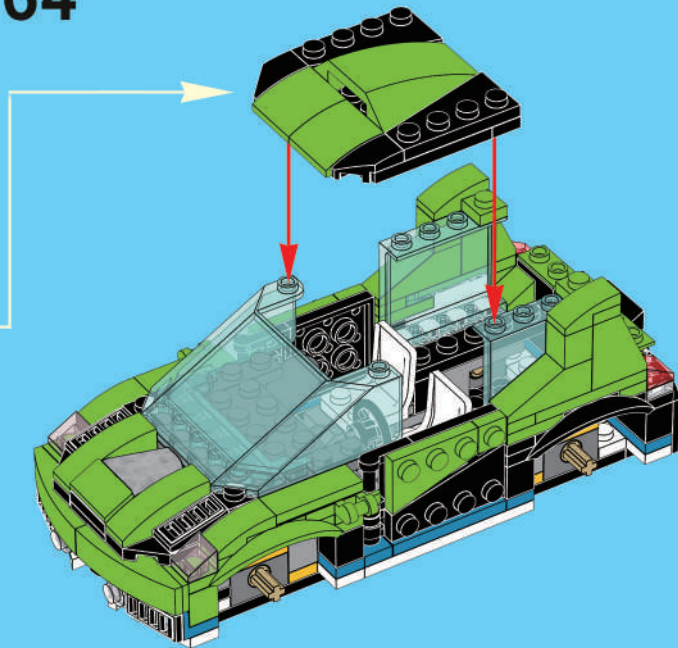



1x

65



2x

66



1x

67

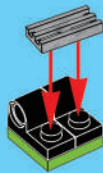

2x

68

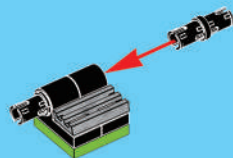

2x

69

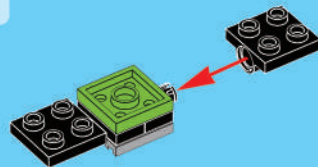

2x

70

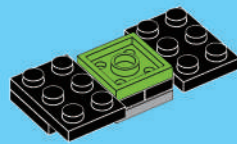



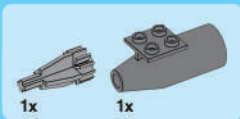

71

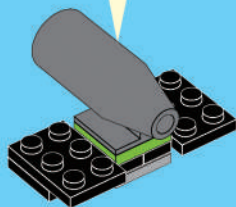
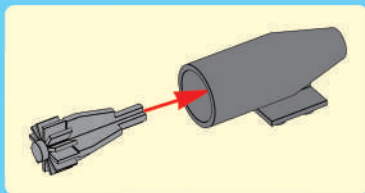

72

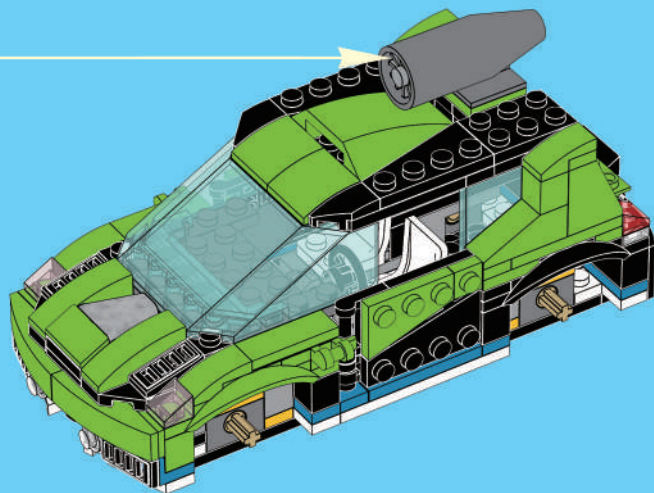

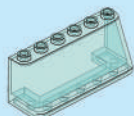

1x

73

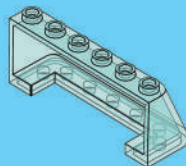

1x



2x

74

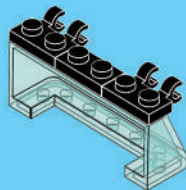

1x

75

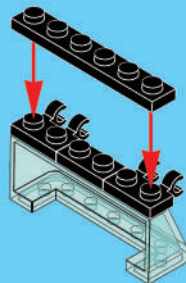

2x

76

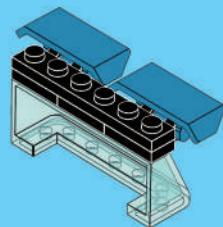

77

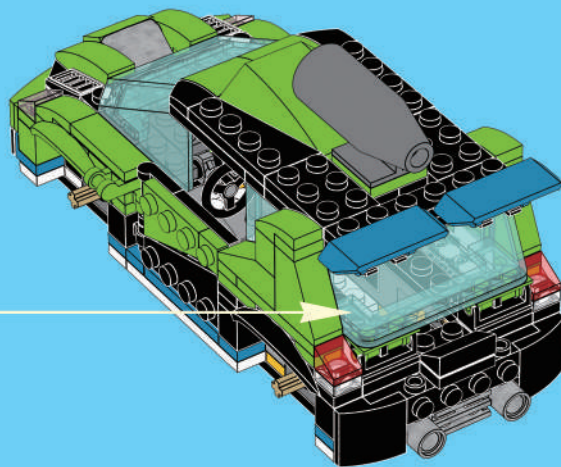



78

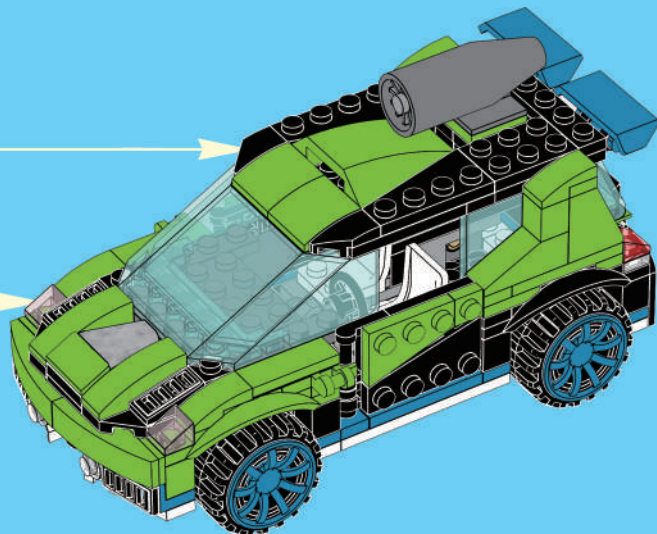
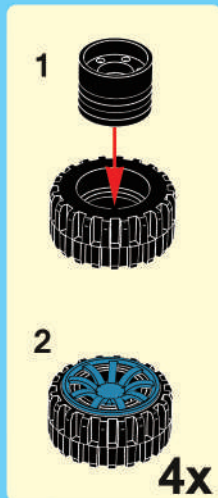

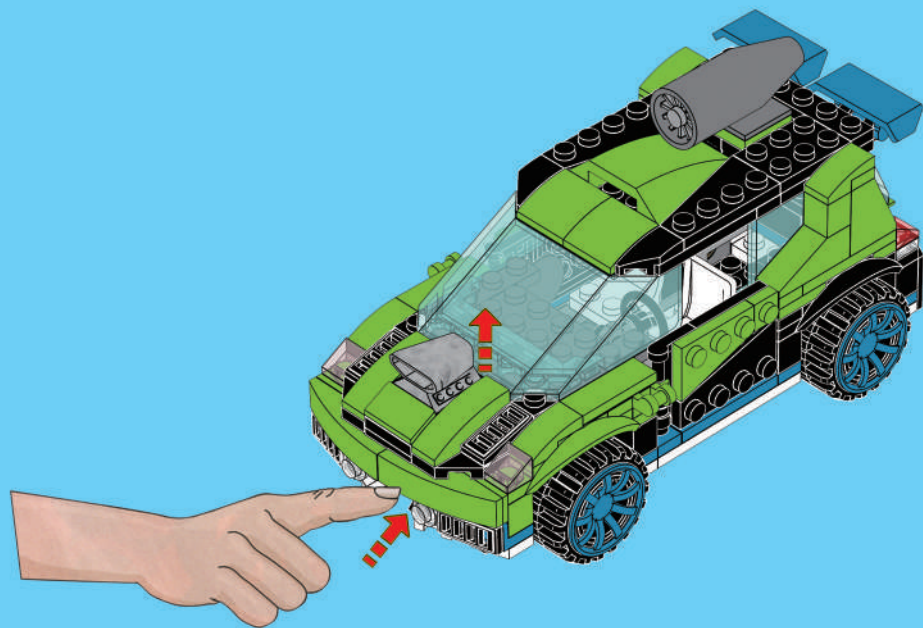

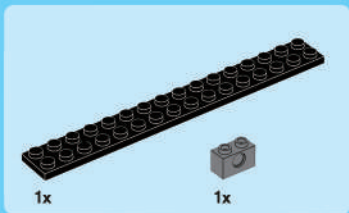

1

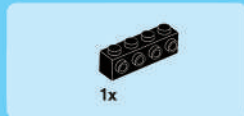
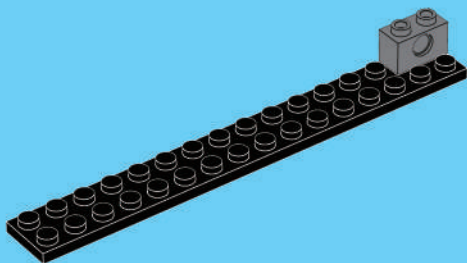

2

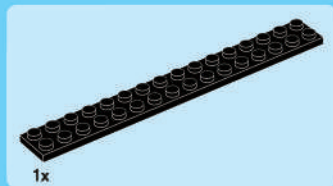
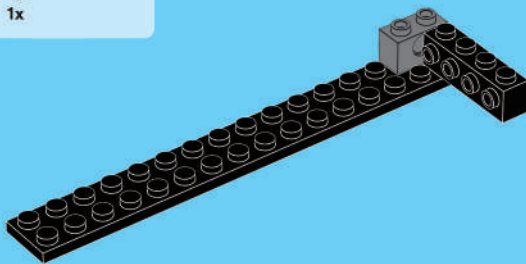

3

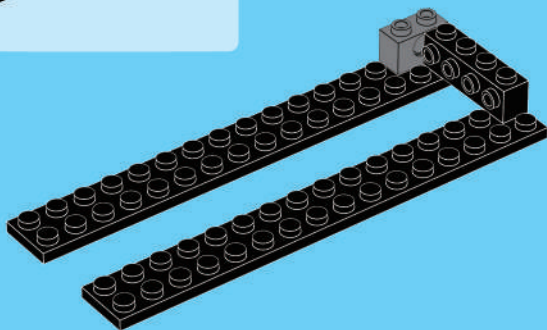



1x

4

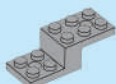
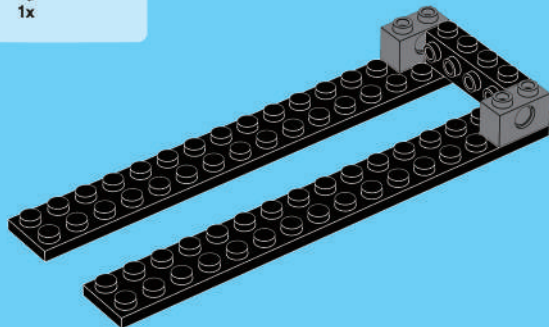

2x

5

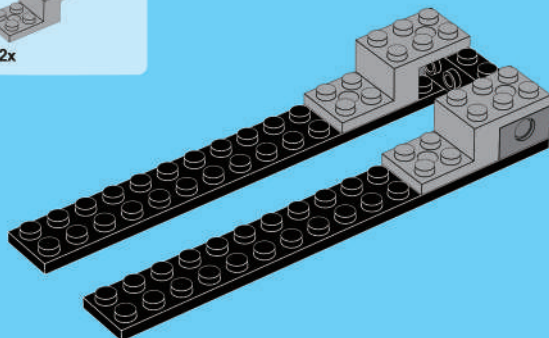

2x



2x



1x

6

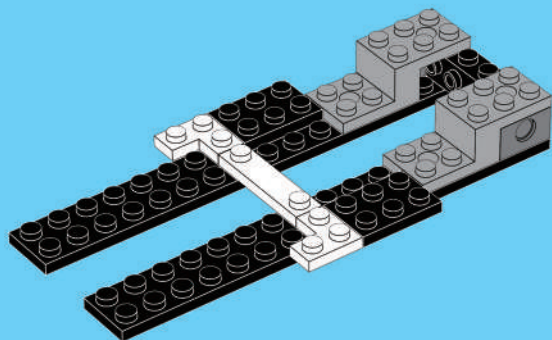



7

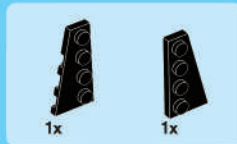
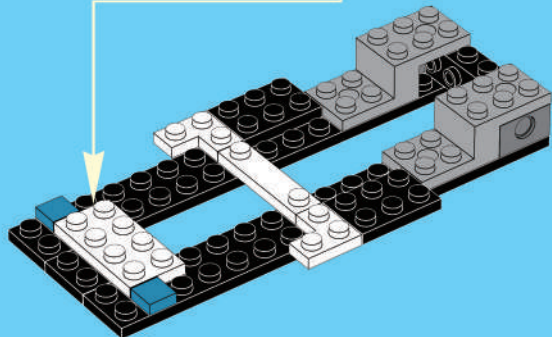
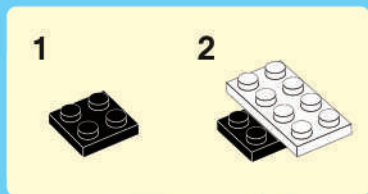

8

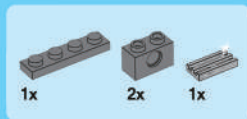
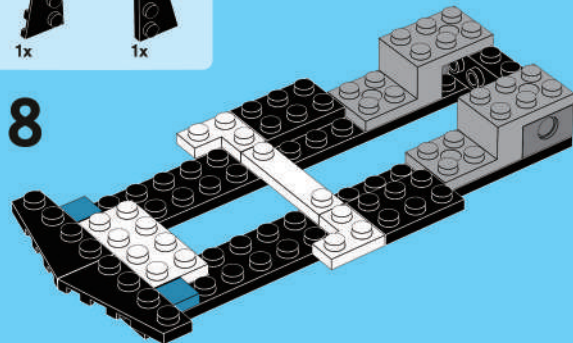

9

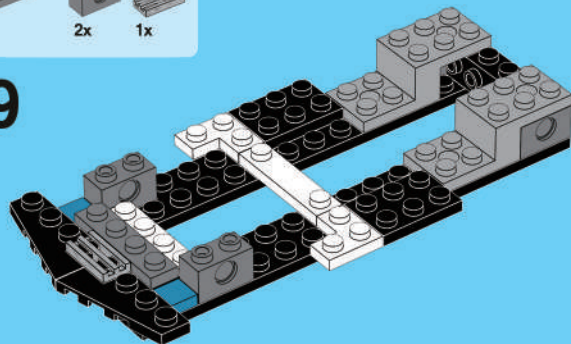



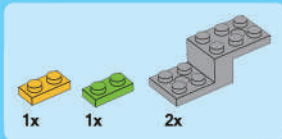

10

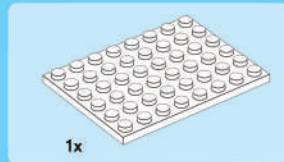
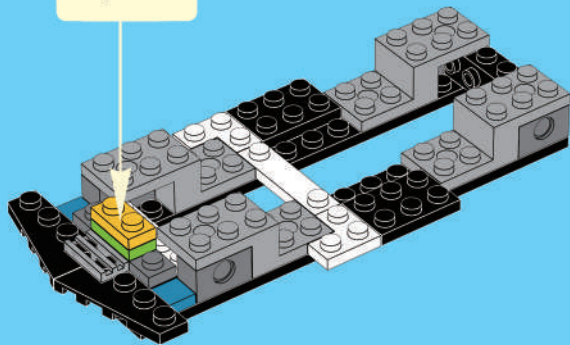
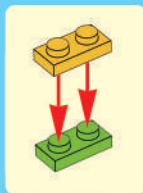

11

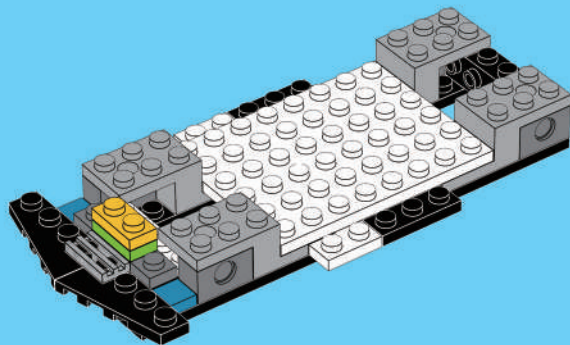

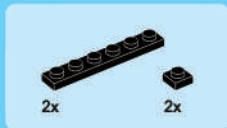

12

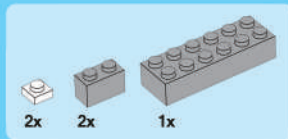
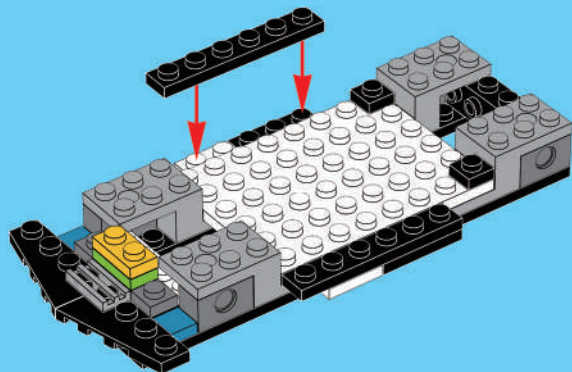

13

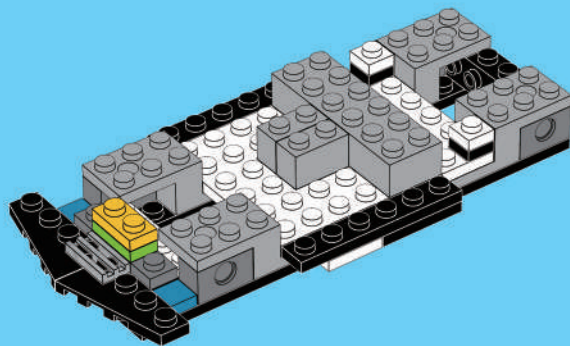



2x



2x

# 14

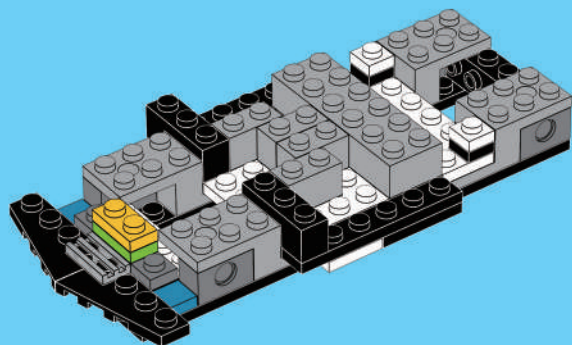

2x



2x

# 15

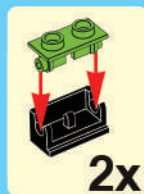

2x

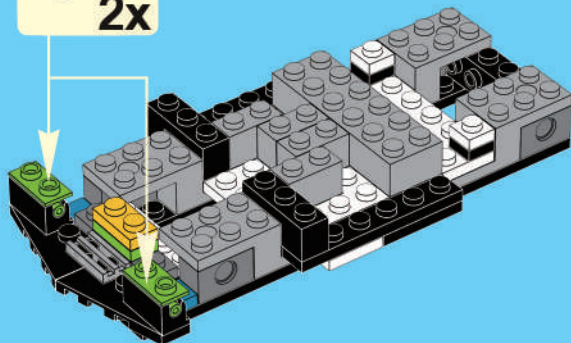



4x



2x

# 16

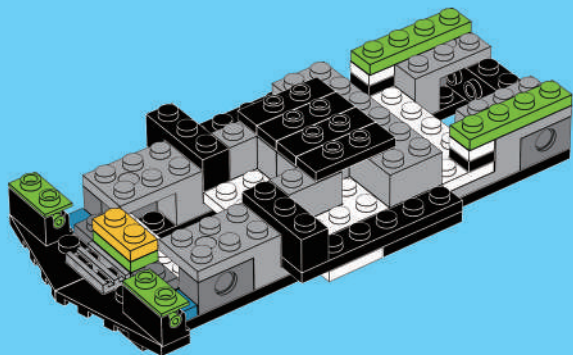

2x



2x



2x

# 17

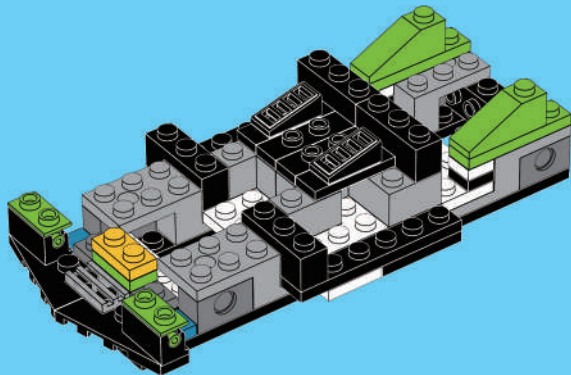



6x

18

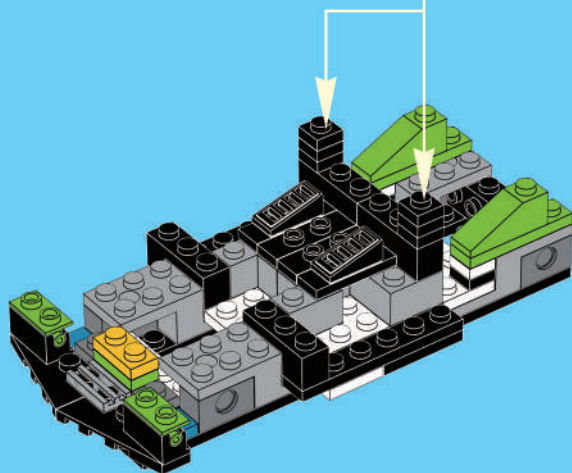
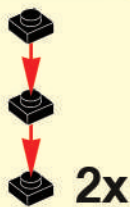

1x

2x

1x

19

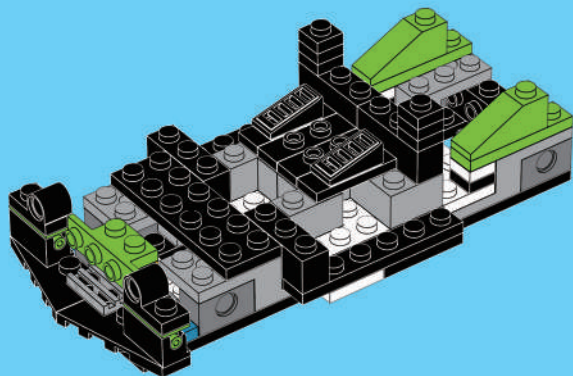

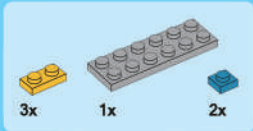

20

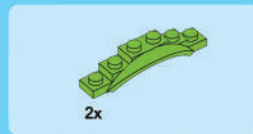
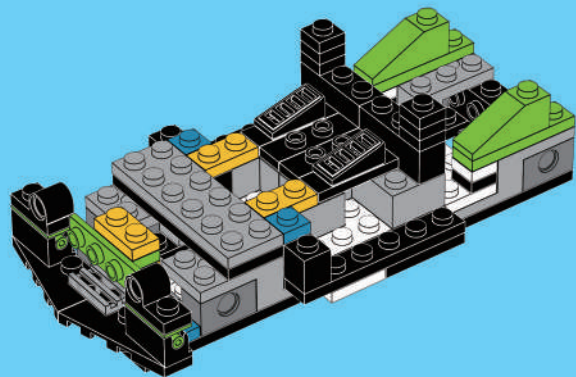

21

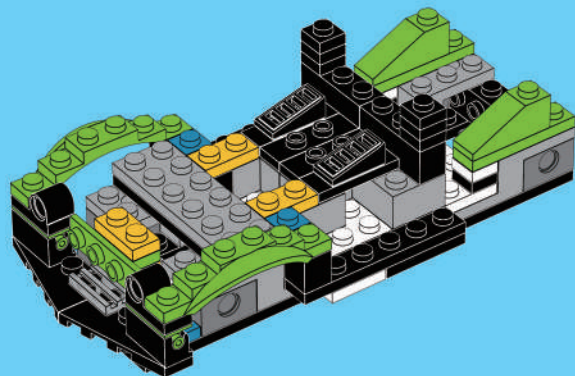

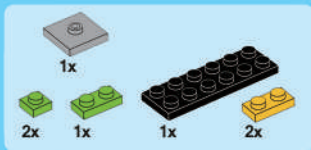

22

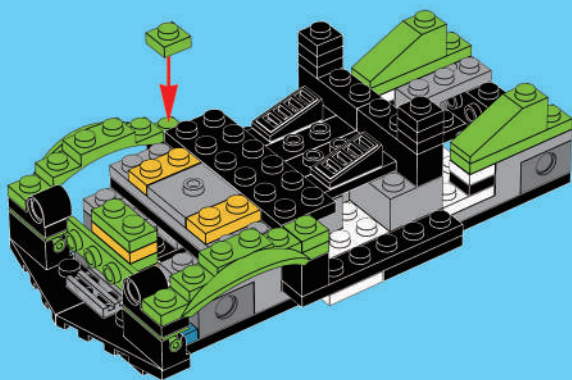

23

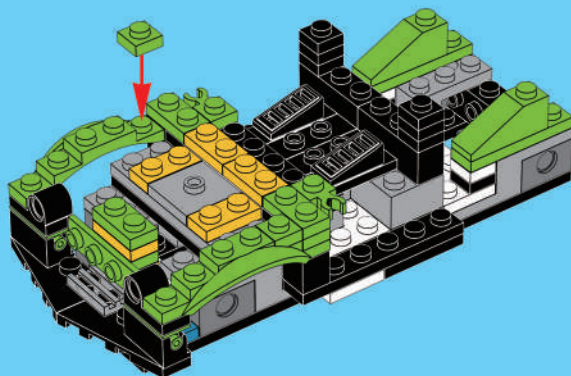

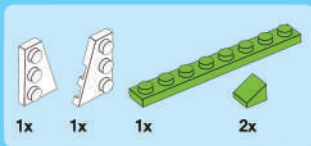

24

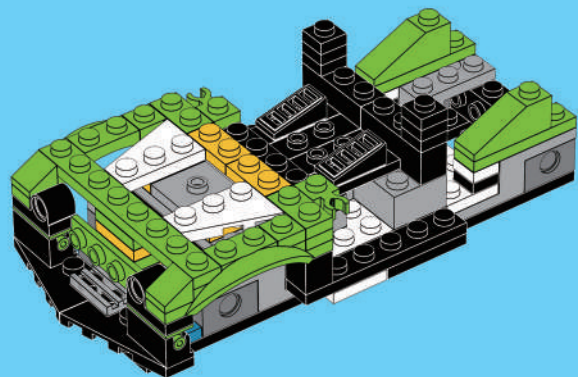

25

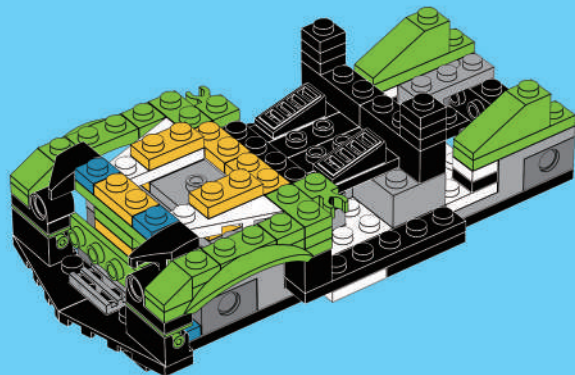



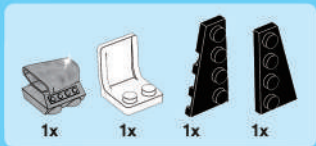

26

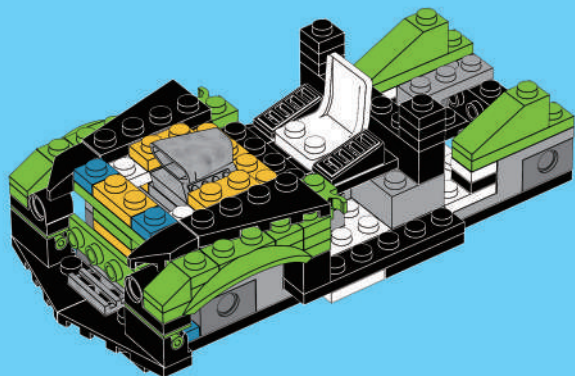

27

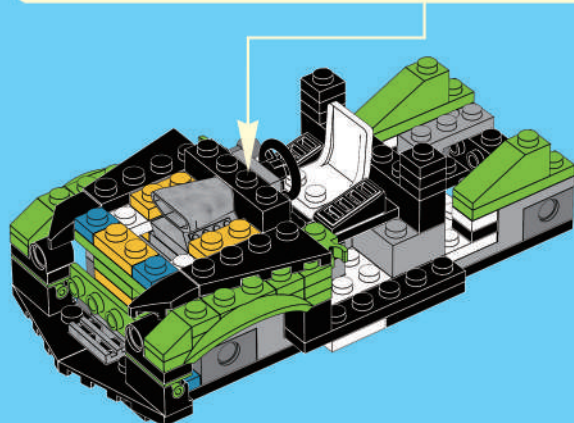
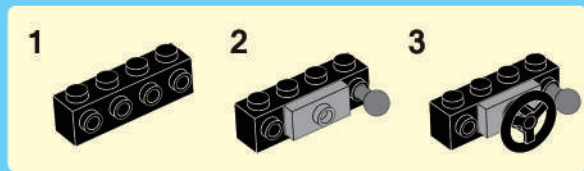

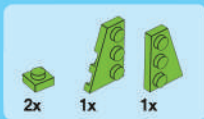

28

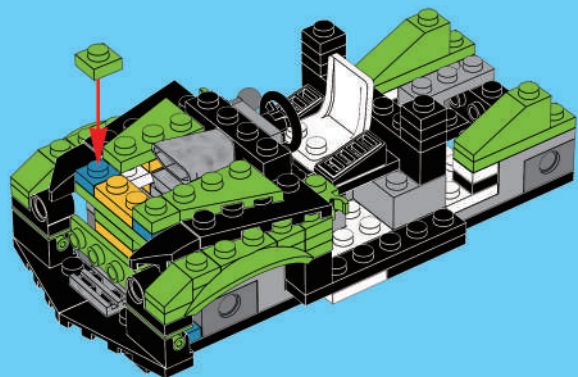

29

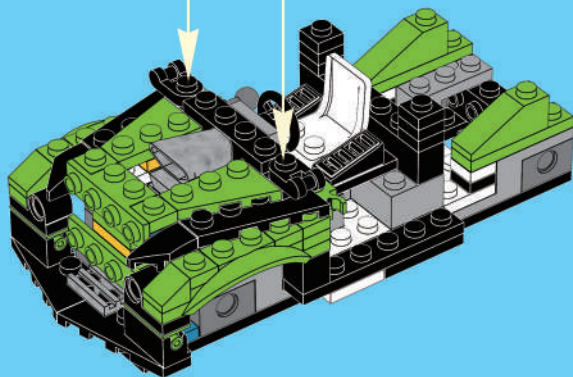

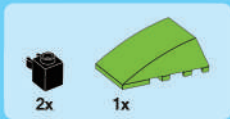

30

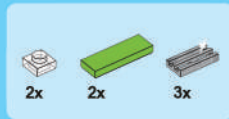
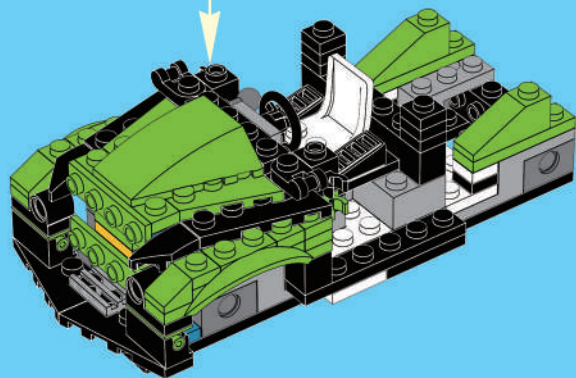

31

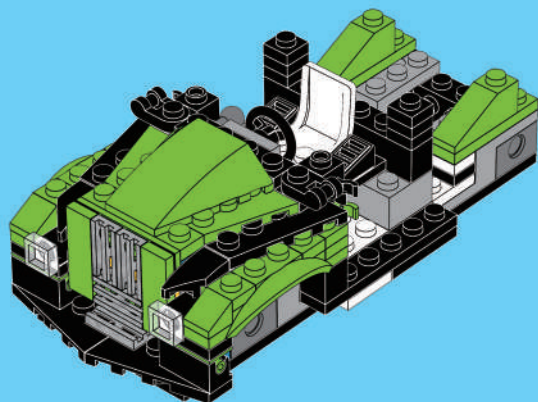



1x

1x

32

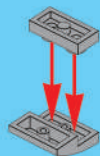

2x

33

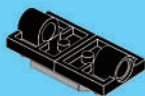

1x

34

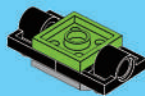

2x

35

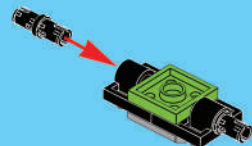

2x

36

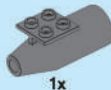
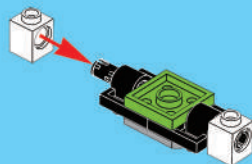

1x

37

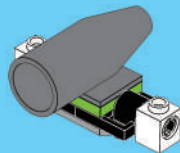



1x

38

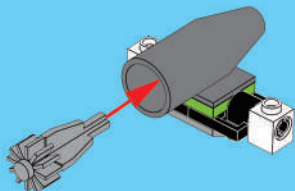

39

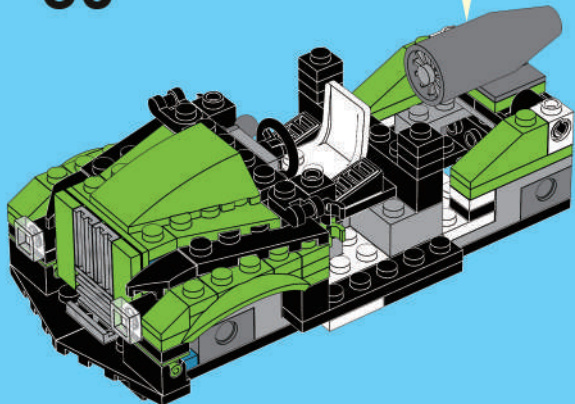

2x

40

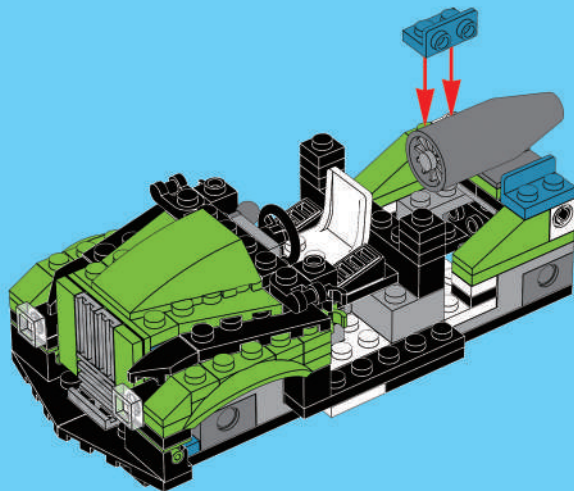

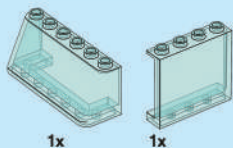

1x

1x

# 41

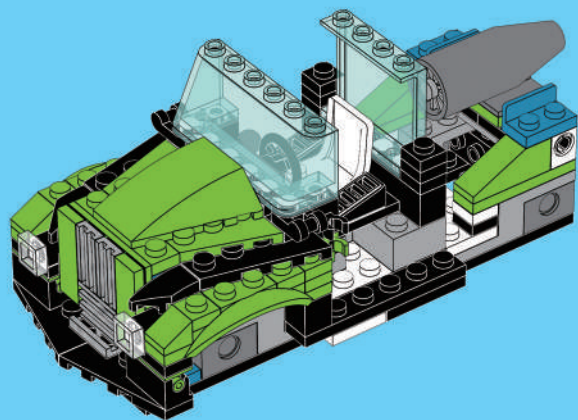

1x

# 42



1x

# 43

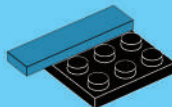

1x

# 44

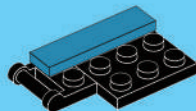



1x

45

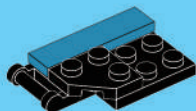

1x

46

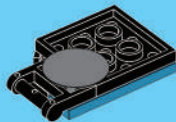

47

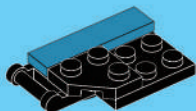

48

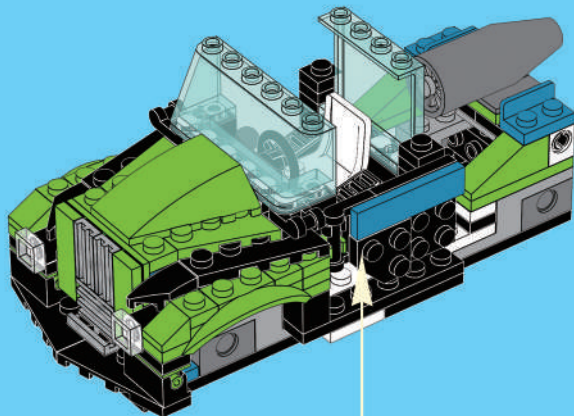



1x

49



1x

50

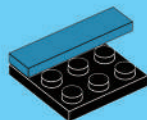

1x

51



1x

52

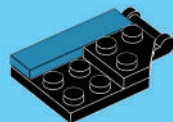

1x

53

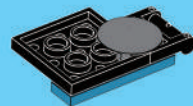

54

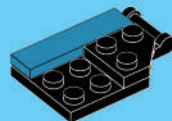



# 55

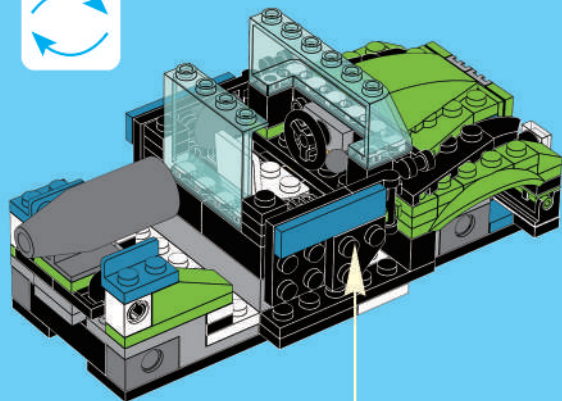

4x



2x

# 56



2x

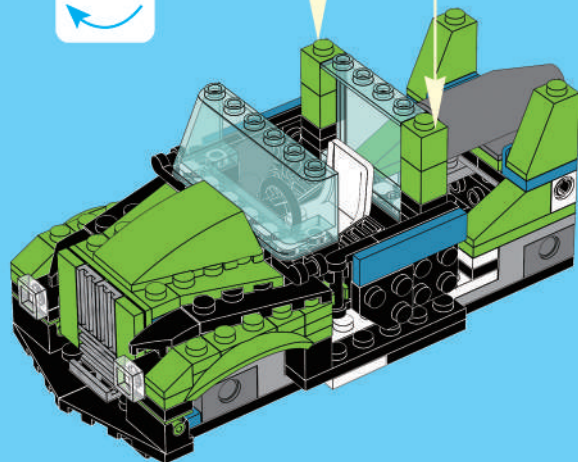



1x

57



2x

58

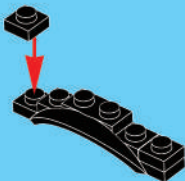

2x

59



2x

60

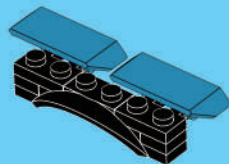

61

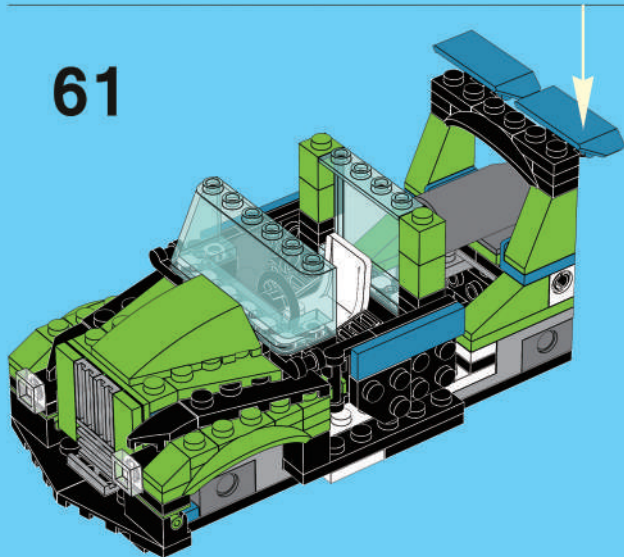



1x

62

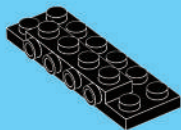

1x

63

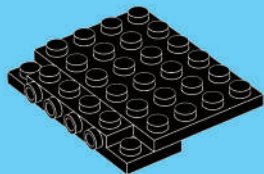

2x

64

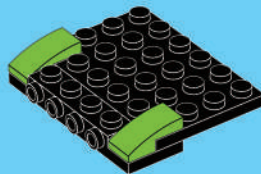

1x

2x

65

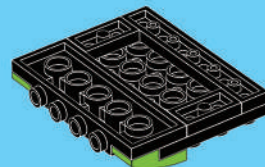



2x

2x

66

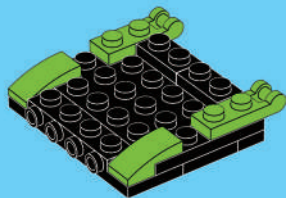

2x

67

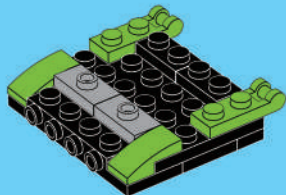

2x

2x

68

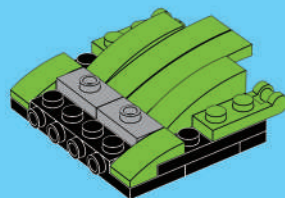

2x

2x

69

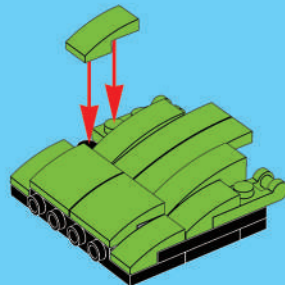



1x



2x

70

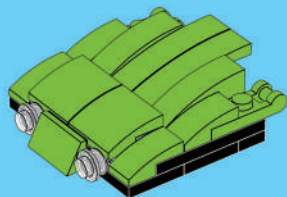

2x

71

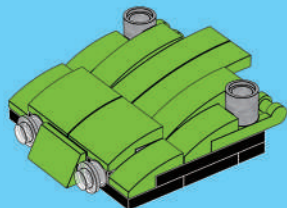

72

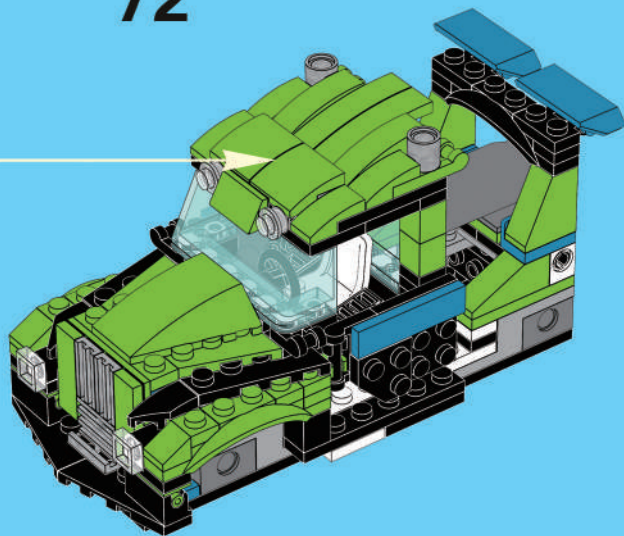



73

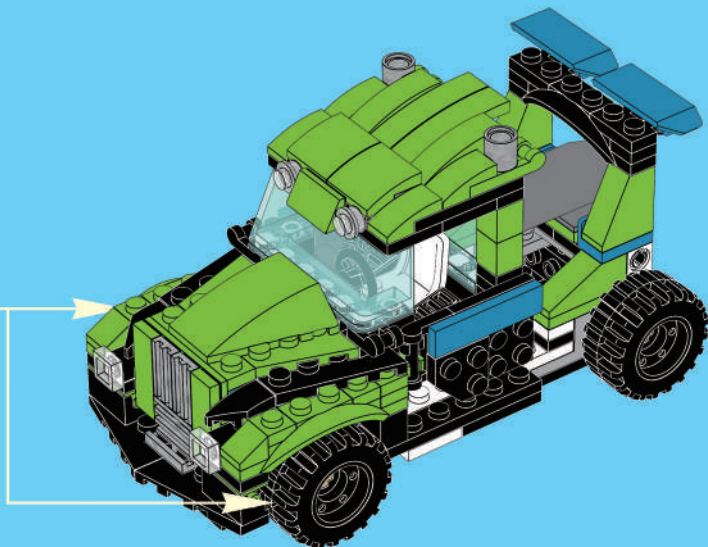
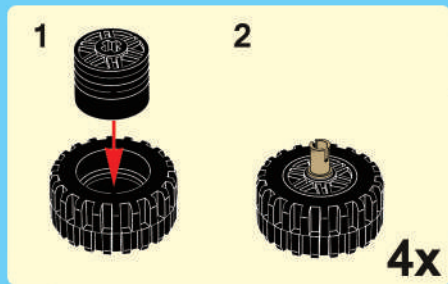



1x

1

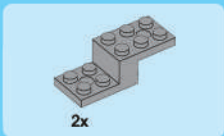
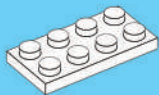

2x

2

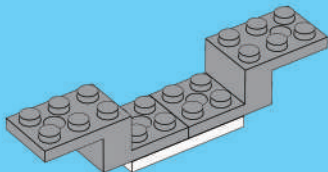

2x

3

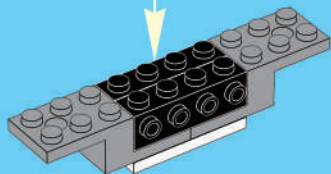
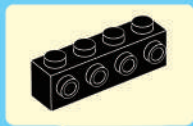

4x

4

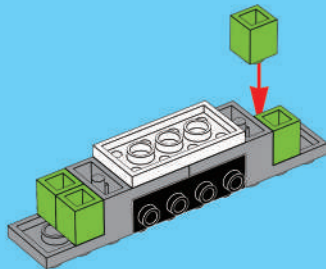

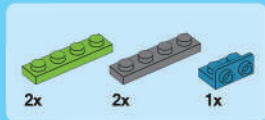

5

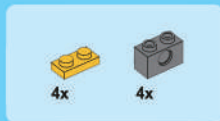
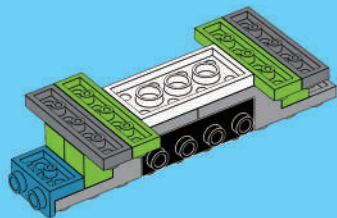

6

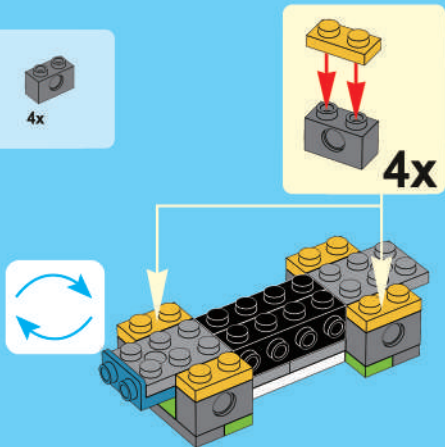

7

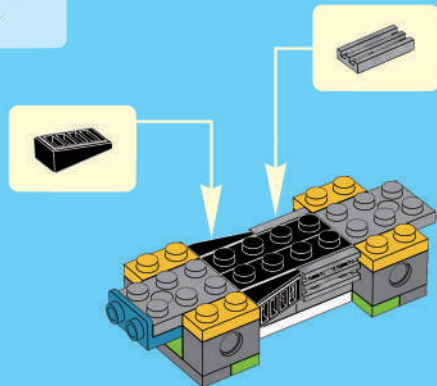

8

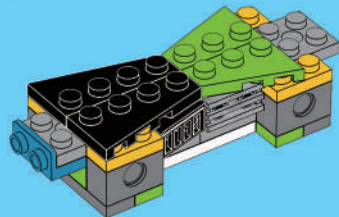



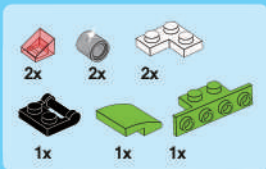

9

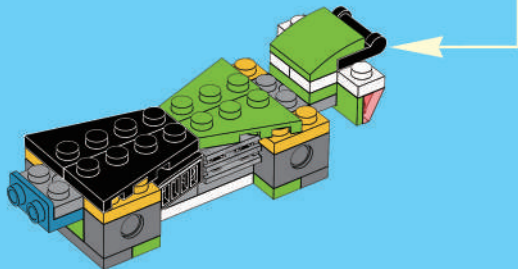
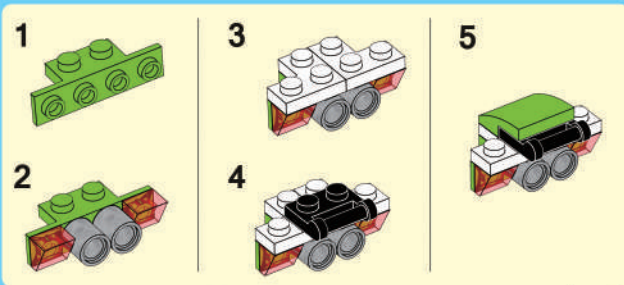

10

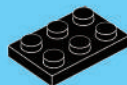

11



12

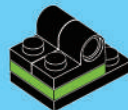



13

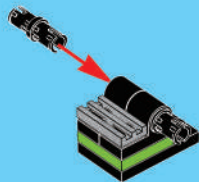

14

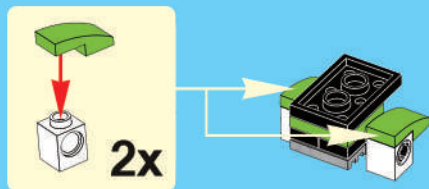

15

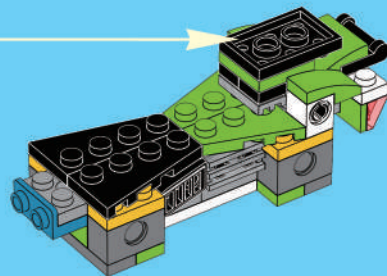

16

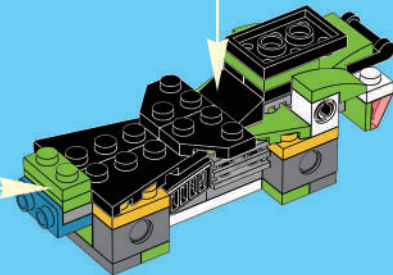
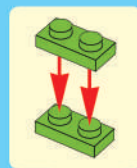



4x



1x

# 17

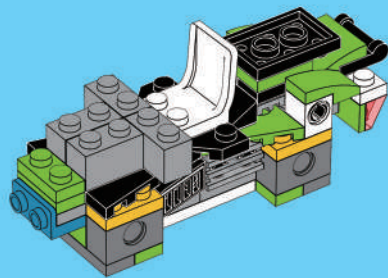

1x



1x



2x

# 18

1

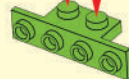

2

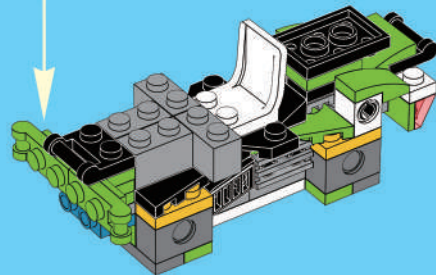
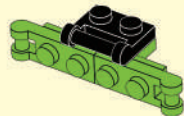

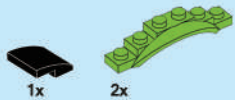

19

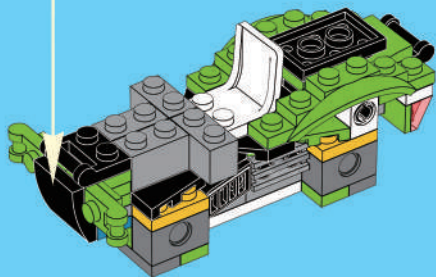

20

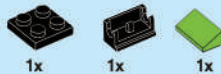
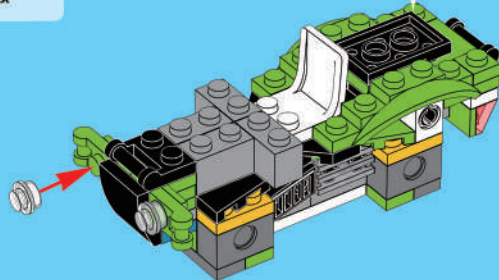

21

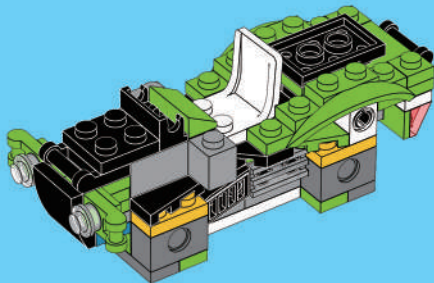



22

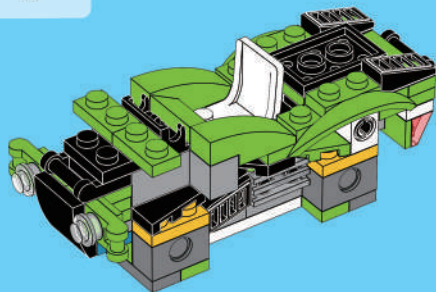

23

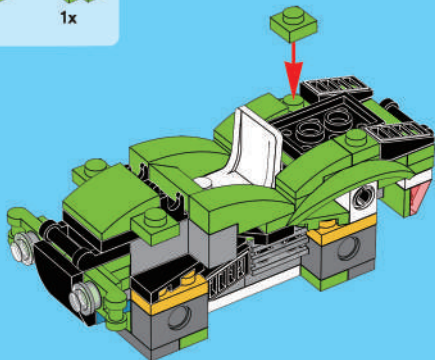

24

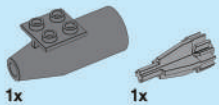
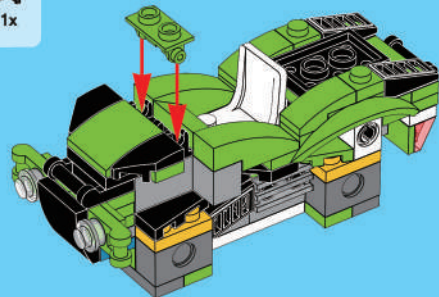

25

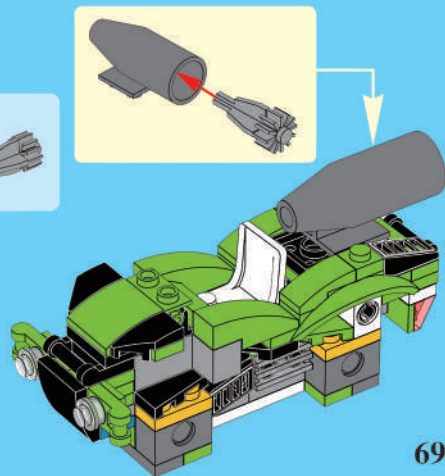

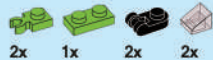

26

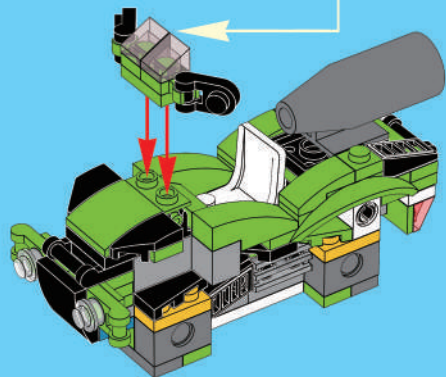
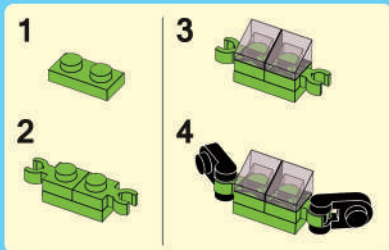

27

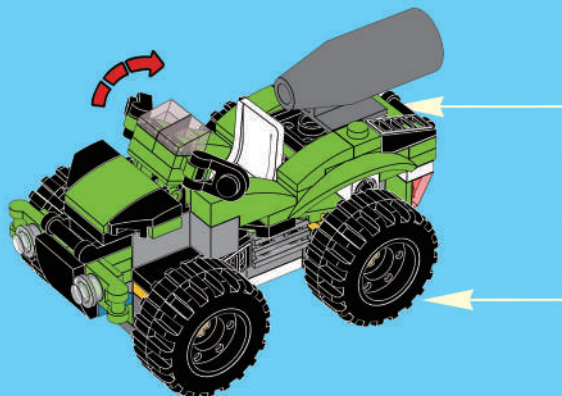
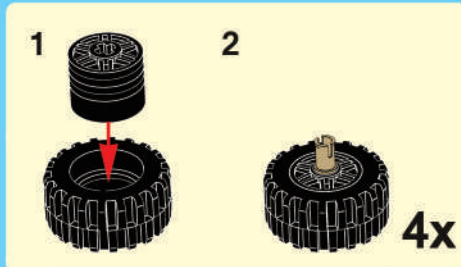

# BRICKS TOYS

IT CAN BE CHANGED  
INTO 3 STATES



3124



3125



3126



3127

# Architect

30  
MODEL

