

ENGINEERING CONSTRUCTION

NO. 29201

6+
ENGINEER

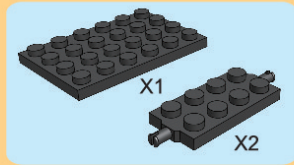

1

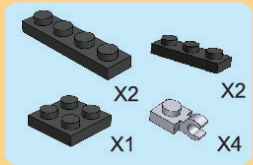
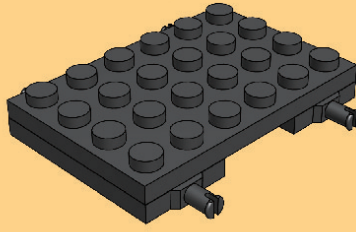

2

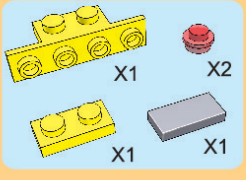
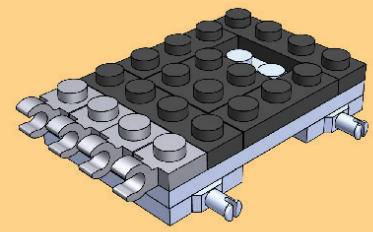

3

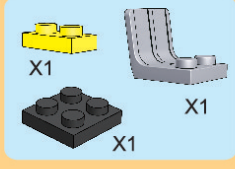
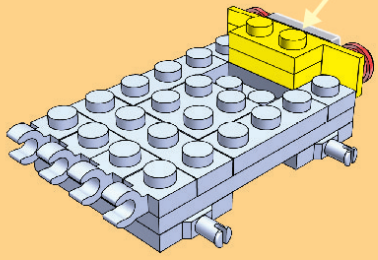

4

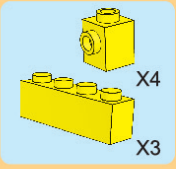
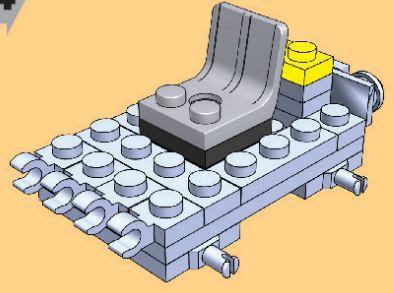

5

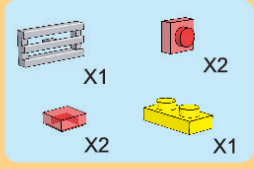
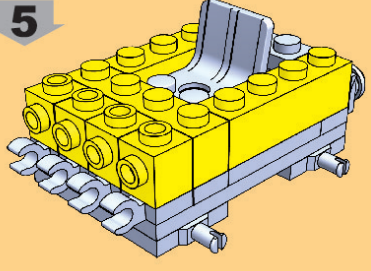

6

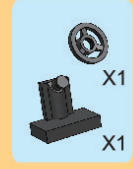
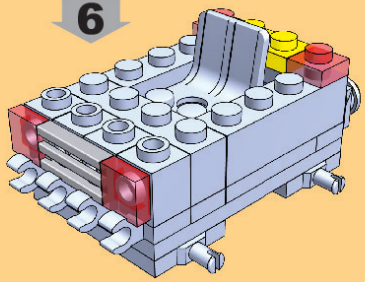

7

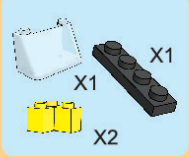
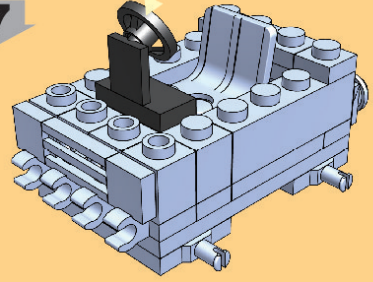

8

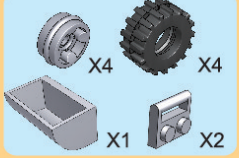
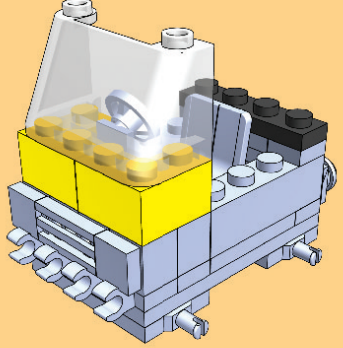

9

