

ASSEMBLY INSTRUCTION FOR MODEL



MA3-5309RR

1:20

EN The ledge is for the squeezing the small details out of the board
 PL Występ w linijce przeznaczony jest do wyłuskania małych detali z arkusza sklejk
 FR La proéminence est conçue pour aider à presser et enlever les petits détails de la feuille
 ES La repisa es para apretar los pequeños detalles fuera del tablero
 DE Der Vorsprung dient dazu, kleine Teile aus den Platten zu drücken
 RU Выступ предназначен для выдавливания из листа мелких деталей
 IT Le proiezioni riportate sui fogli di istruzioni sono utili anche nella fase di smontaggio per estrarre i pezzi
 CN 輔助測量尺可幫助取出或壓接細小零件時使用

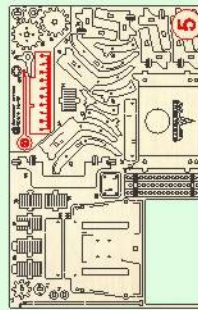

EN Use for the change the length
 PL Stosować do wyznaczenia długości
 FR Appliquer pour définir la longueur
 ES Utilizar para determinar la longitud
 DE Zur Änderung der Länge verwenden
 RU Использовать для определения длины
 IT Usare per determinare la lunghezza
 CN 用它来测量长度

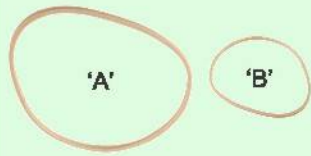
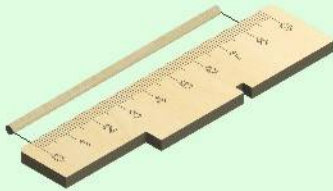

EN Rubber bands
 PL Gumki recepturki
 FR Des élastiques
 ES Gomas elásticas
 DE Gummibänder
 RU Резинки
 IT Elastici
 CN 橡膠皮筋



EN Cut it with a razor blade
 PL Odeinij nożem do kopert
 FR Couper avec un cutter
 ES Cortar con un bisturí
 DE Mit Rasierdinge durchschneiden
 RU Обрезать канцелярским ножом
 IT Tagliare con un coltello da cancelleria
 CN 用刀片切斷



EN Remove the burrs with sandpaper
 PL Usunąć zadziorły papierem ściętym
 FR Retirer les bavures avec du papier à polir
 ES Quitar las rebabas con el papel esmeril
 DE Grate mit Schleifpapier entfernen
 RU Удалить заусенцы наждачной бумагой
 IT Sbravare con carta vetrata
 CN 用砂紙去除毛刺。



EN Details should rotate freely
 PL Swobodnie obracanie
 FR Libre rotation
 ES Rotación libre
 DE Auf freier Rotation achten
 RU Свободное вращение
 IT Rotazione libera
 CN 流暢地旋轉



EN Wax it with a candle
 PL Posmaruj za pomocą świecy parafinowej
 FR Graisser avec une bougie de paraffine
 ES Engrasar con ayuda de una vela de parafina
 DE Mit einer Kerze wachsen
 RU Смазать парафиновой свечой
 IT Lubrificare con candela di paraffina
 CN 用干蠟燭上蠟滑



EN Pay attention
 PL Uwaga
 FR Préter attention
 ES Prestar atención
 DE Achtung
 RU Уделить внимание
 IT Prestare attenzione
 CN 請注意

EN The manufacturer reserves the right to make changes in the design of the product, not worsening its technical characteristics. Information about the changes made may not be present in this manual.
 PL Producent zastrzega sobie prawo do zmian konstrukcyjnych wyrobu bez pogorszenia jego właściwości technicznych. Niniejsza instrukcja może nie zawierać informacji o zmianach.
 FR Le producteur se réserve le droit d'apporter des modifications dans la construction du produit à condition si elles ne portant atteinte à ses caractéristiques techniques. Les renseignements sur les modifications apportées peuvent ne pas être dans la présente notice.
 ES El fabricante se reserva el derecho de introducir modificaciones en la construcción del producto, que no empeoran sus características técnicas. Datos sobre modificaciones introducidas pueden no aparecer en esta instrucción.
 DE Der Hersteller behält sich das Recht auf Designänderungen, die die technischen Merkmale und Funktionen nicht negativ beeinflussen, vor.
 RU Производитель оставляет за собой право вносить изменения в конструкцию изделия, не ухудшающие его технические характеристики. Сведения о внесенных изменениях могут отсутствовать в настоящей инструкции.
 IT Il produttore si riserva il diritto di apportare modifiche al design del prodotto, non peggiorando le sue caratteristiche tecniche. Informazioni sulle modifiche apportate potrebbero non essere presenti in questo manuale.
 CN 制造商保留对产品设计的权利，一切改良旨在增强产品的技术性能。改良处若未出现在手册中，敬请谅解

57

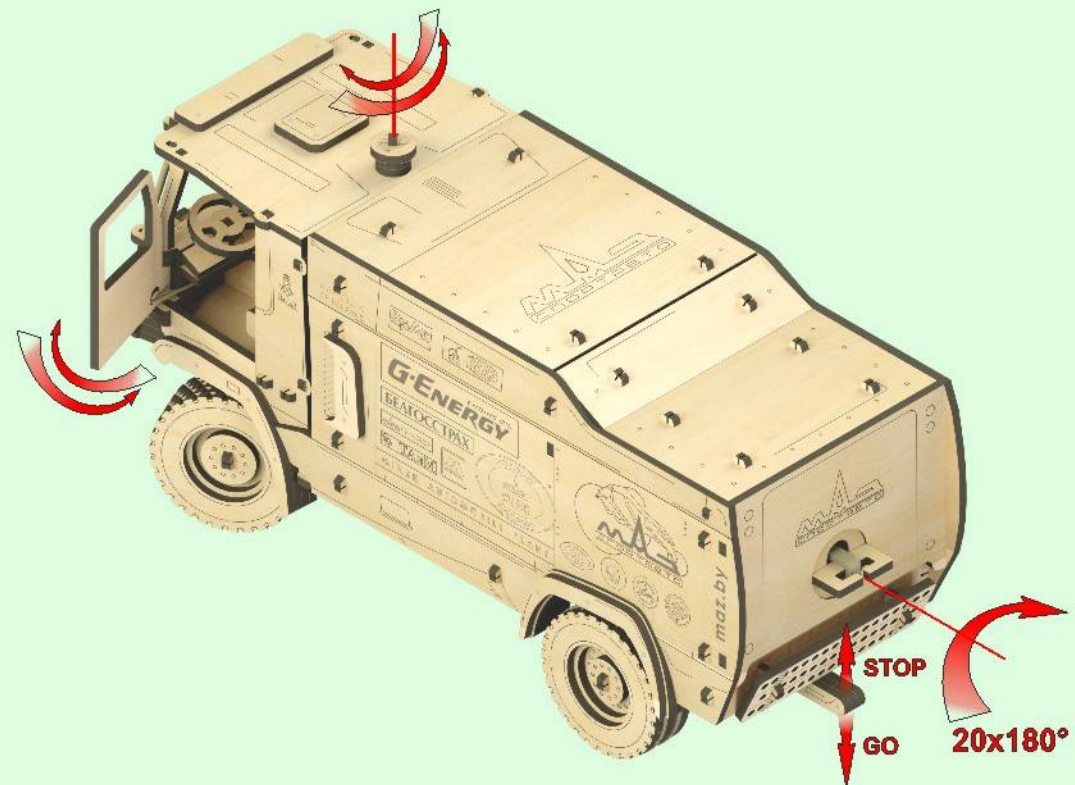
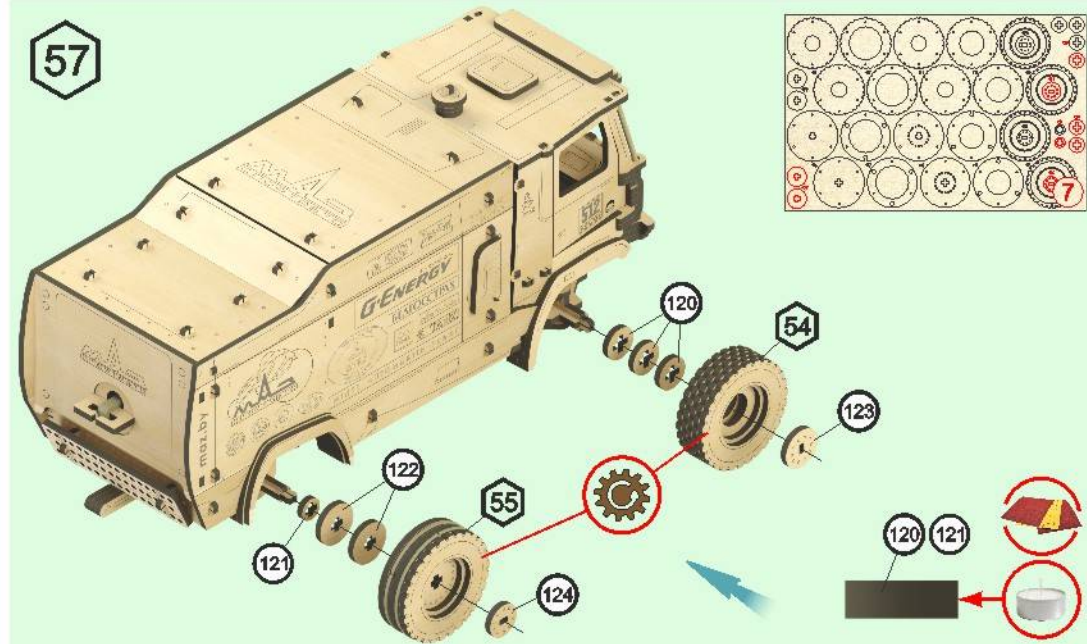

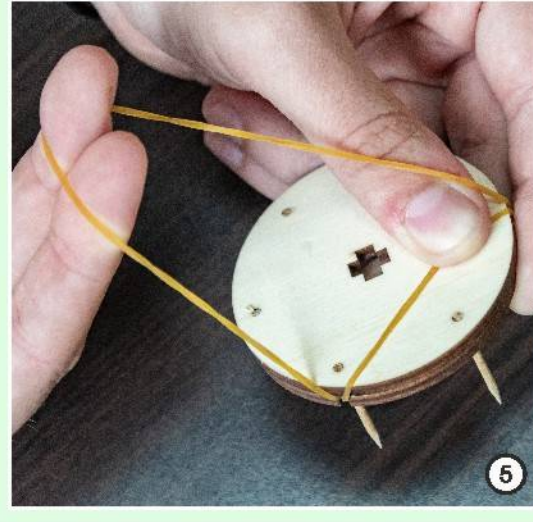
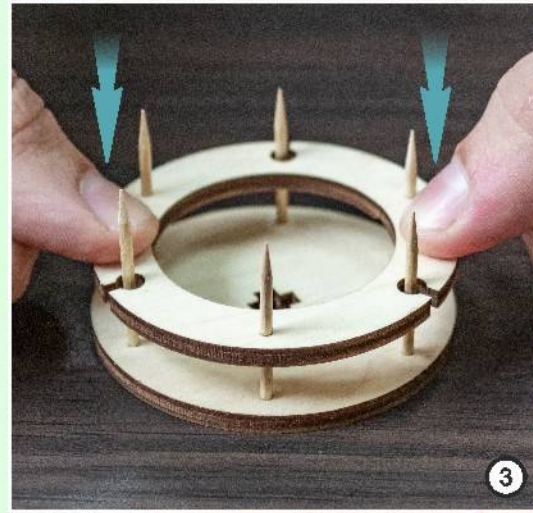
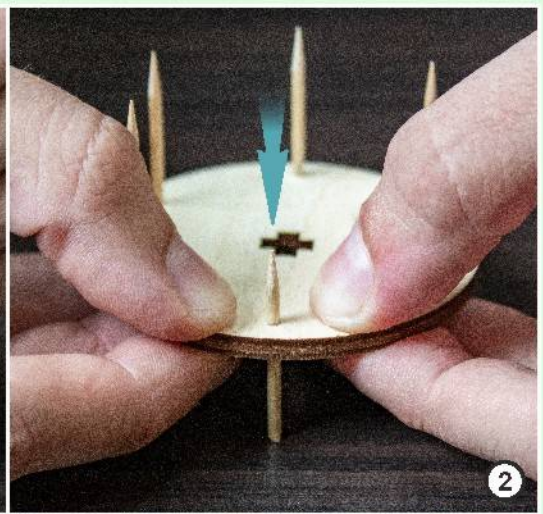
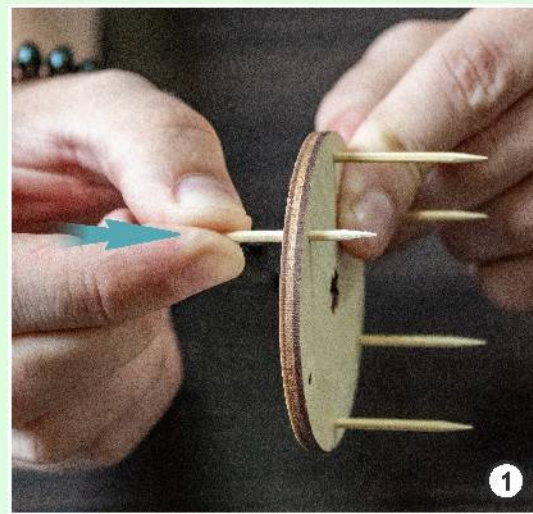
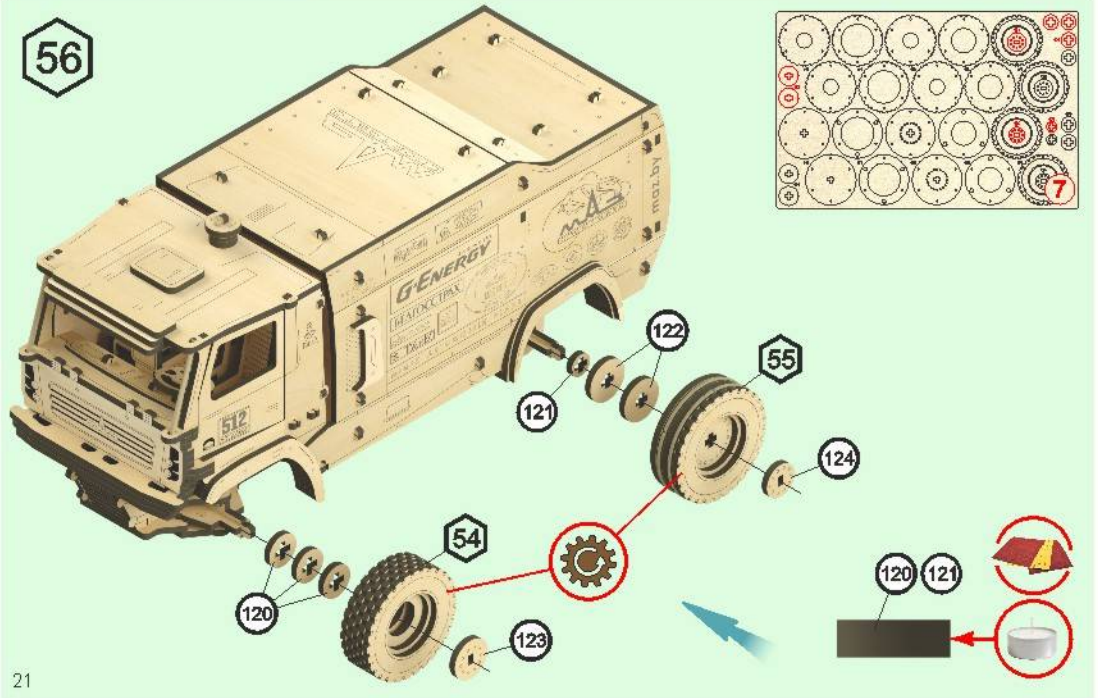
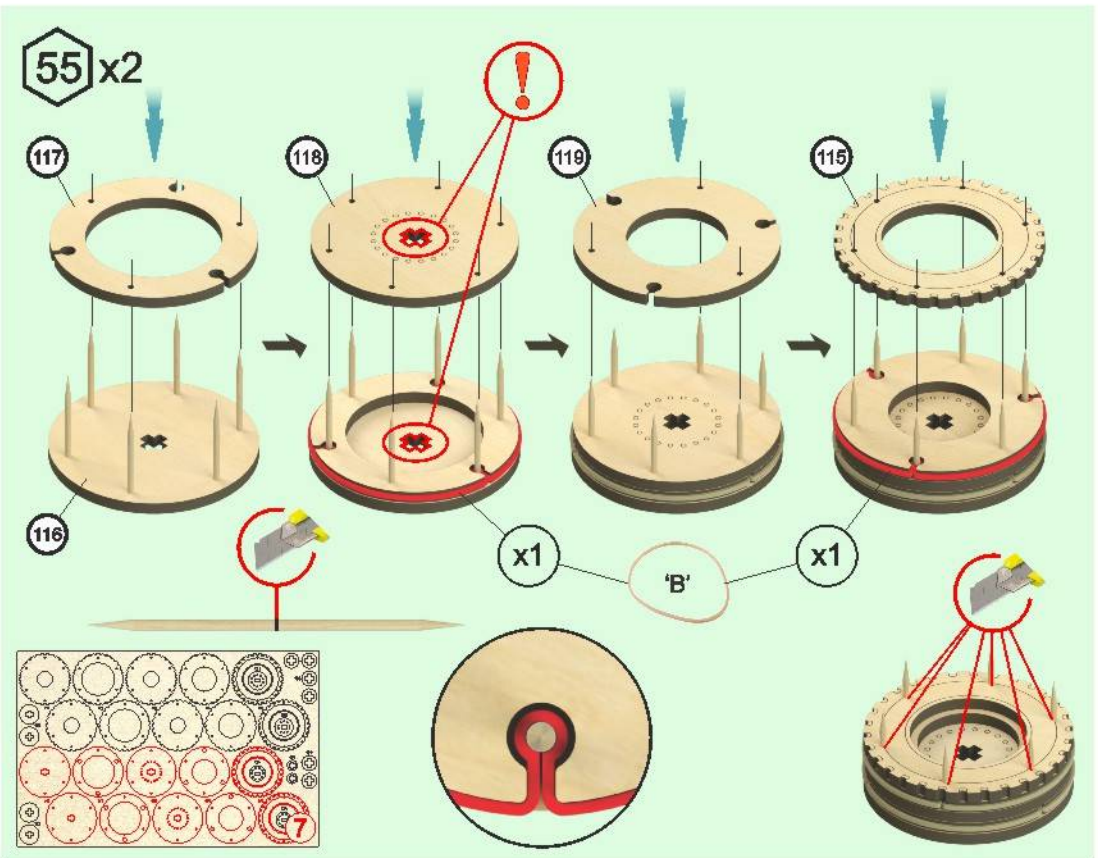

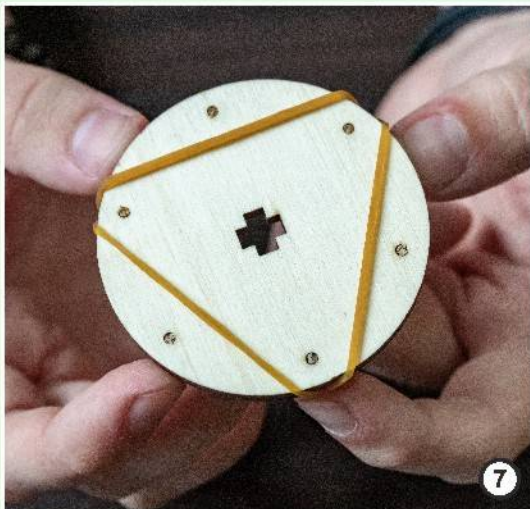

7

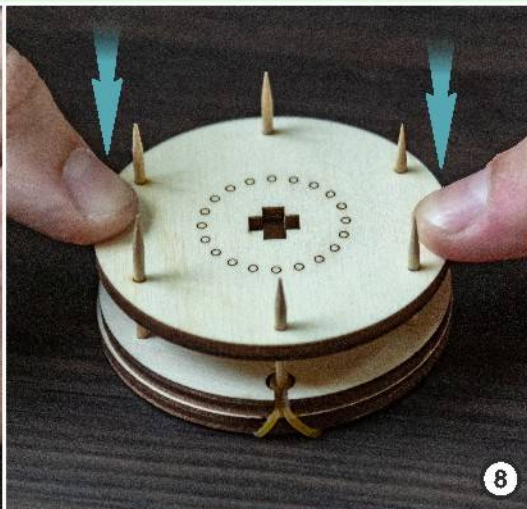

8

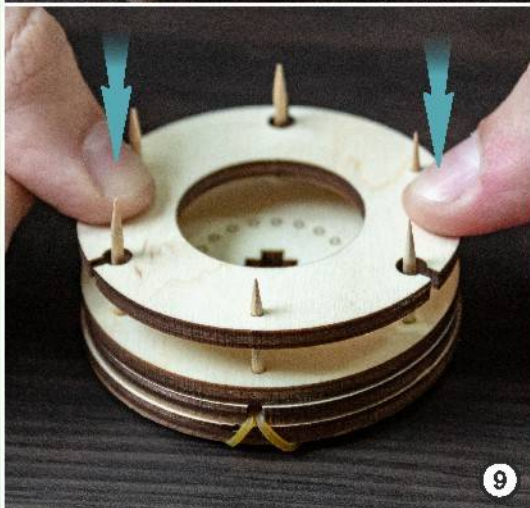

9



Repeat 5 - 8

10



11



12

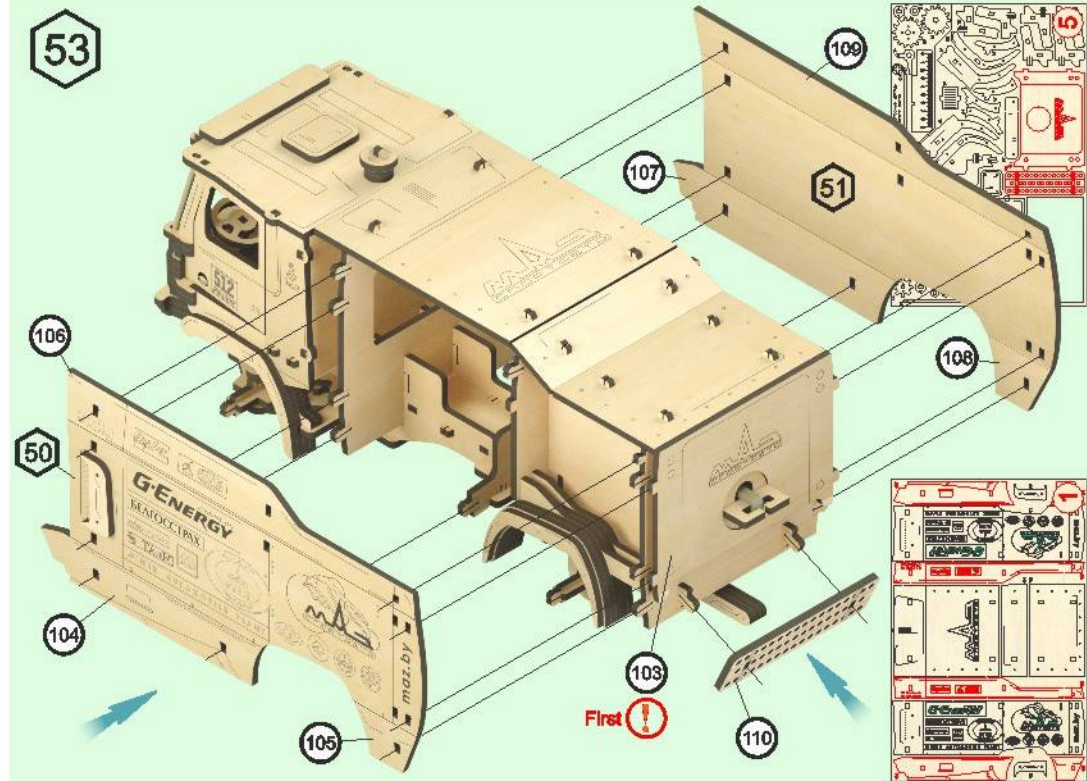

53

109

51

107

108

106

50

104

103

110

First

105

54 x2

112

113

114

115

111

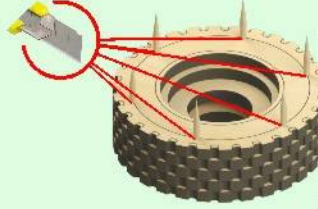
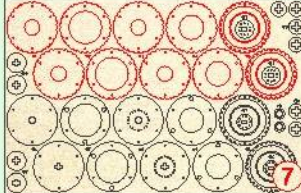

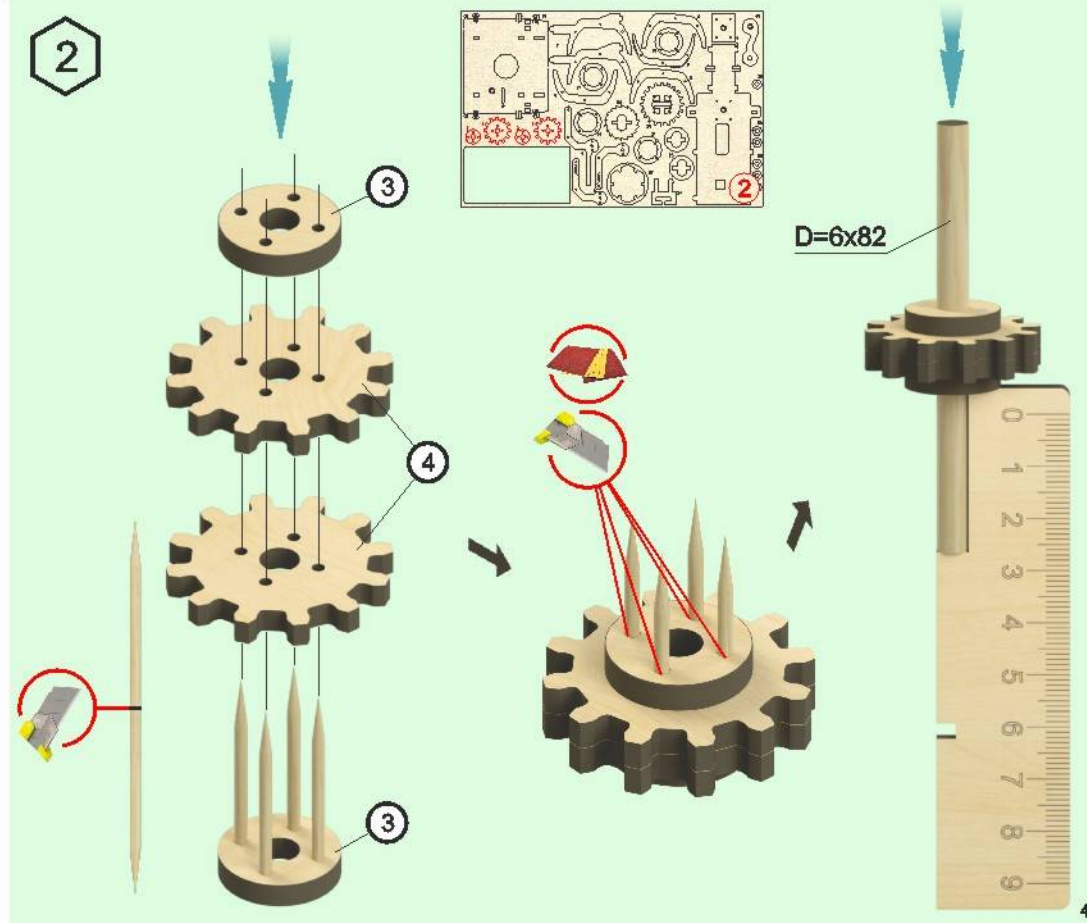
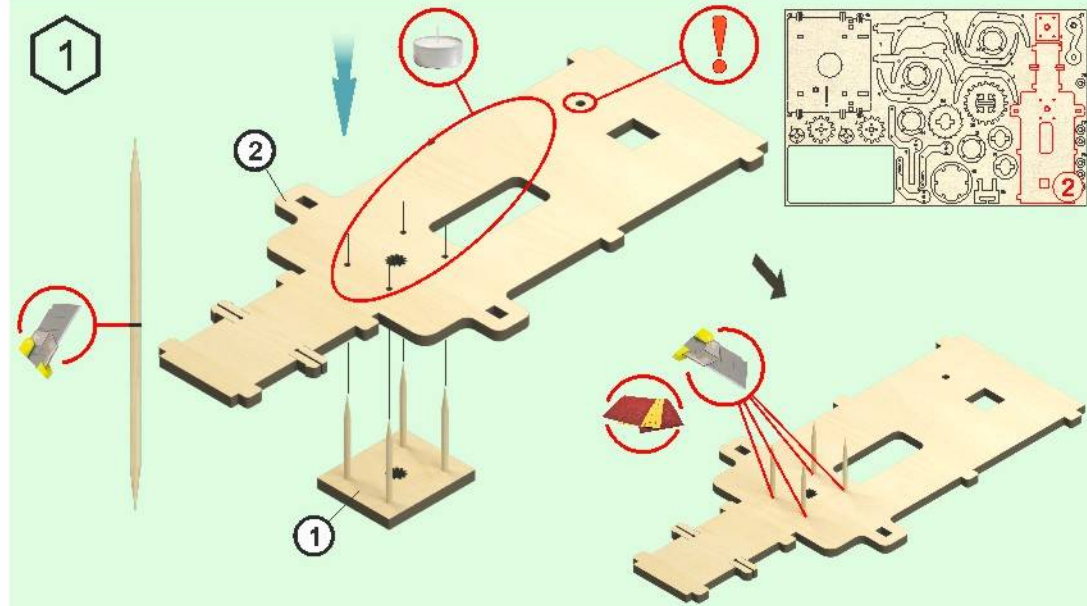
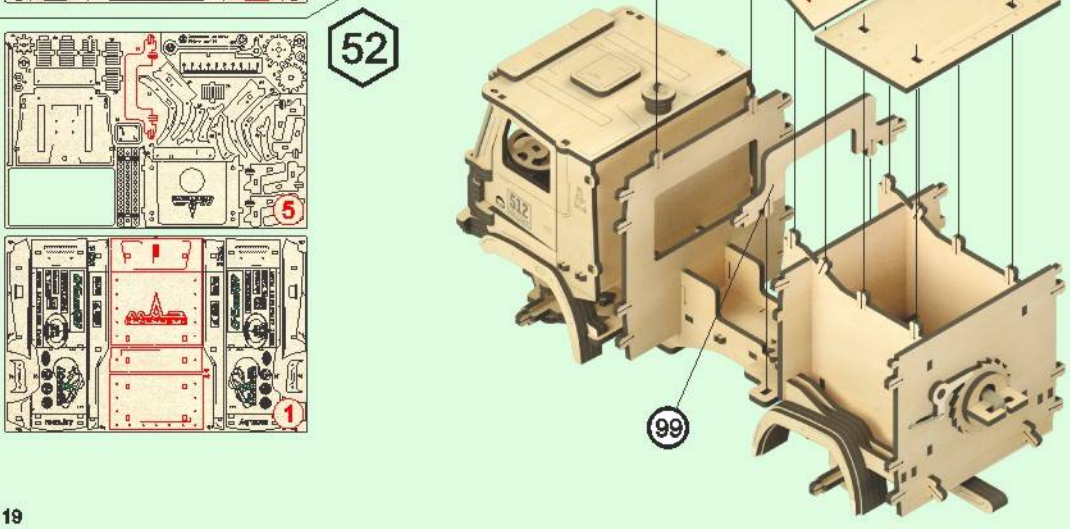
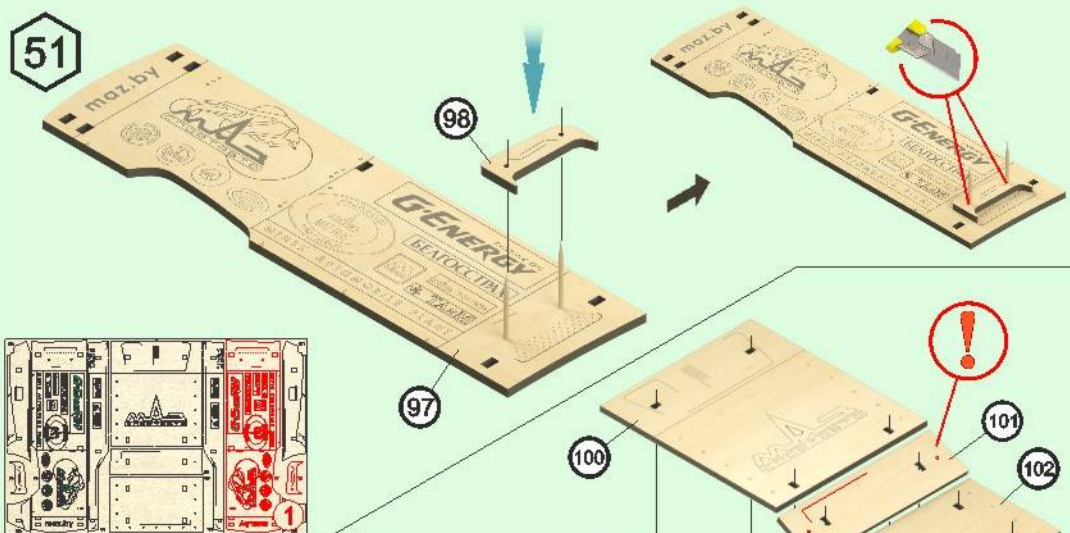
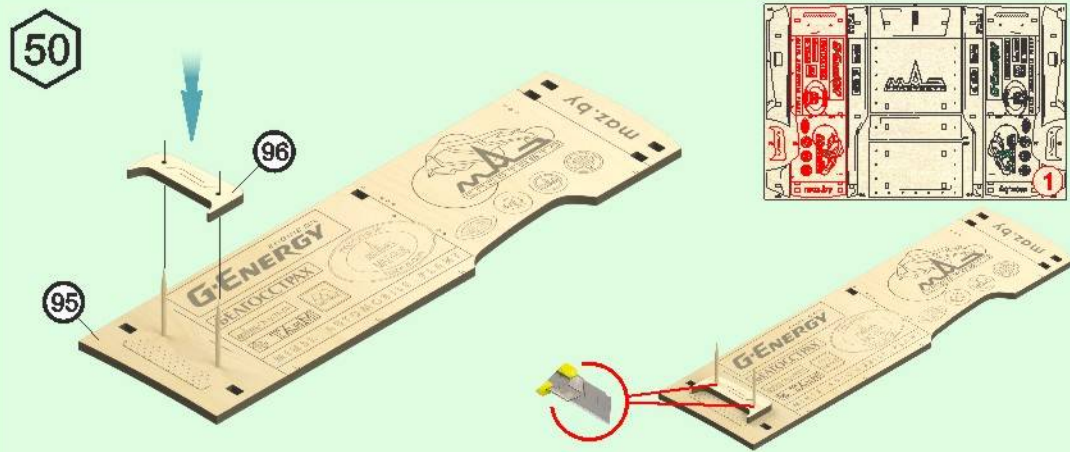

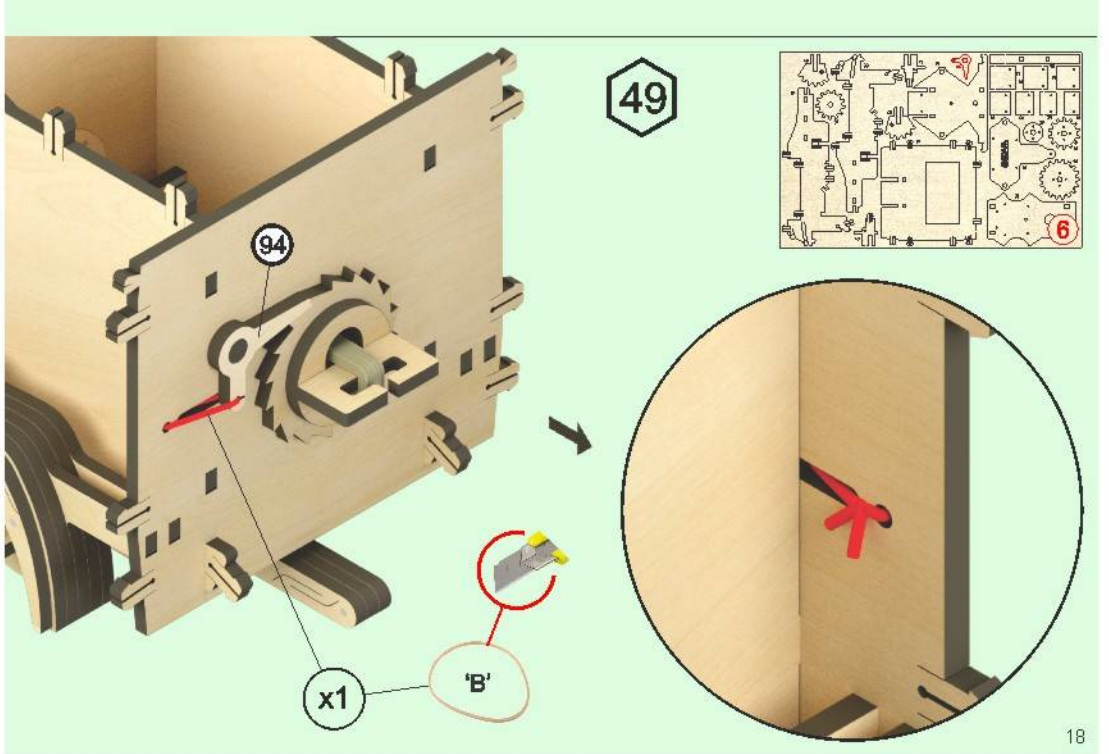
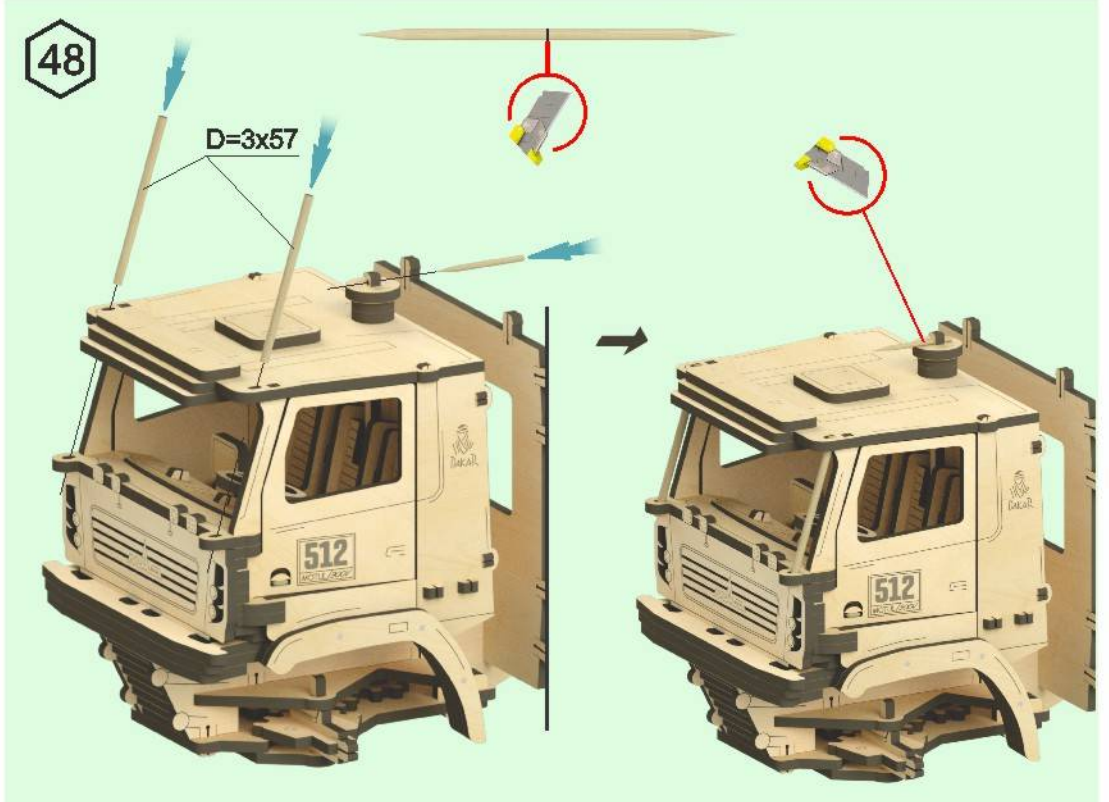
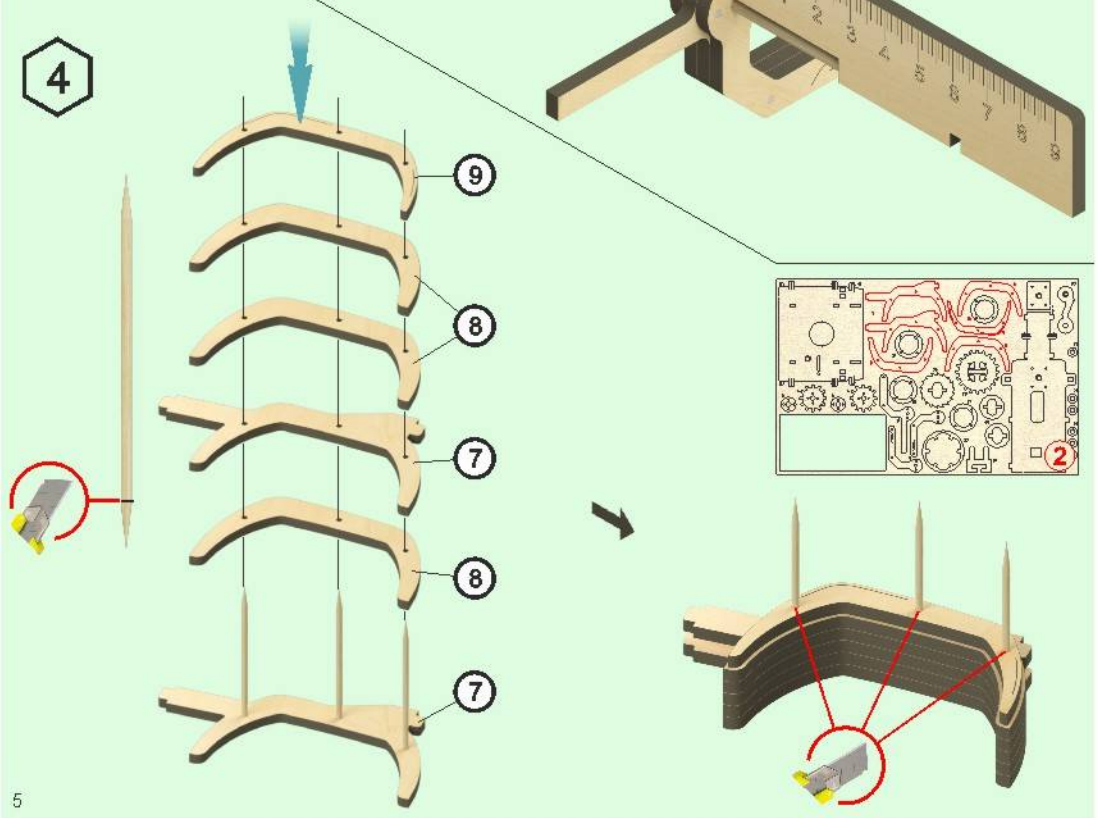
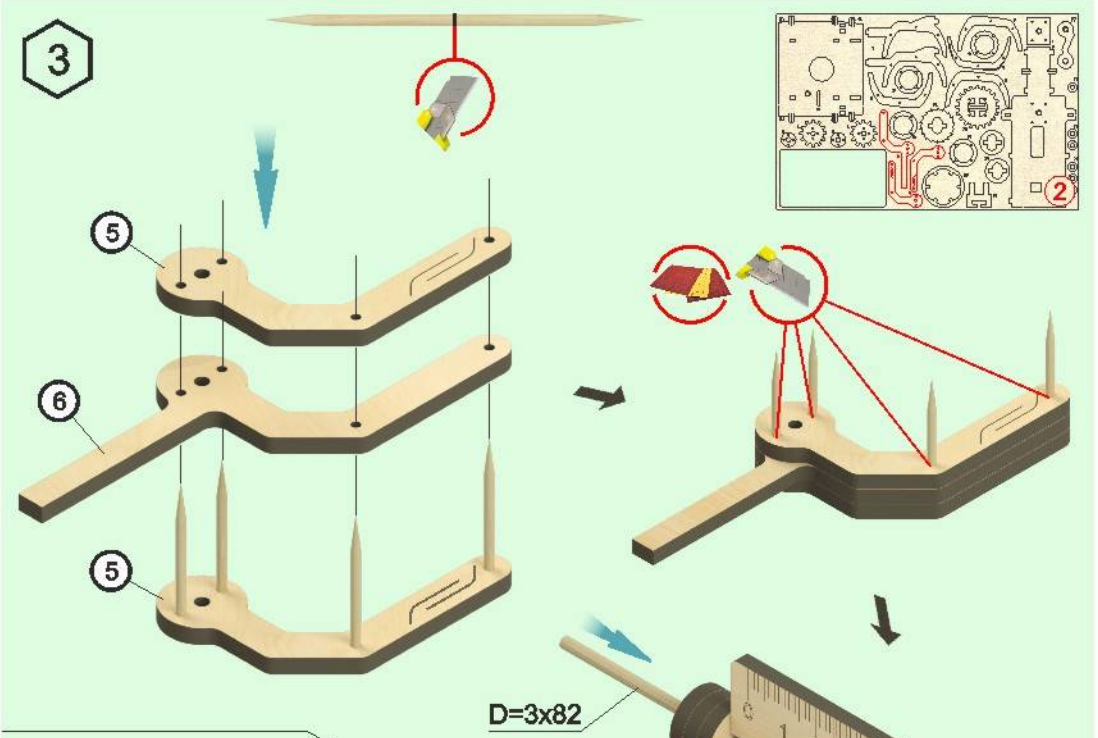

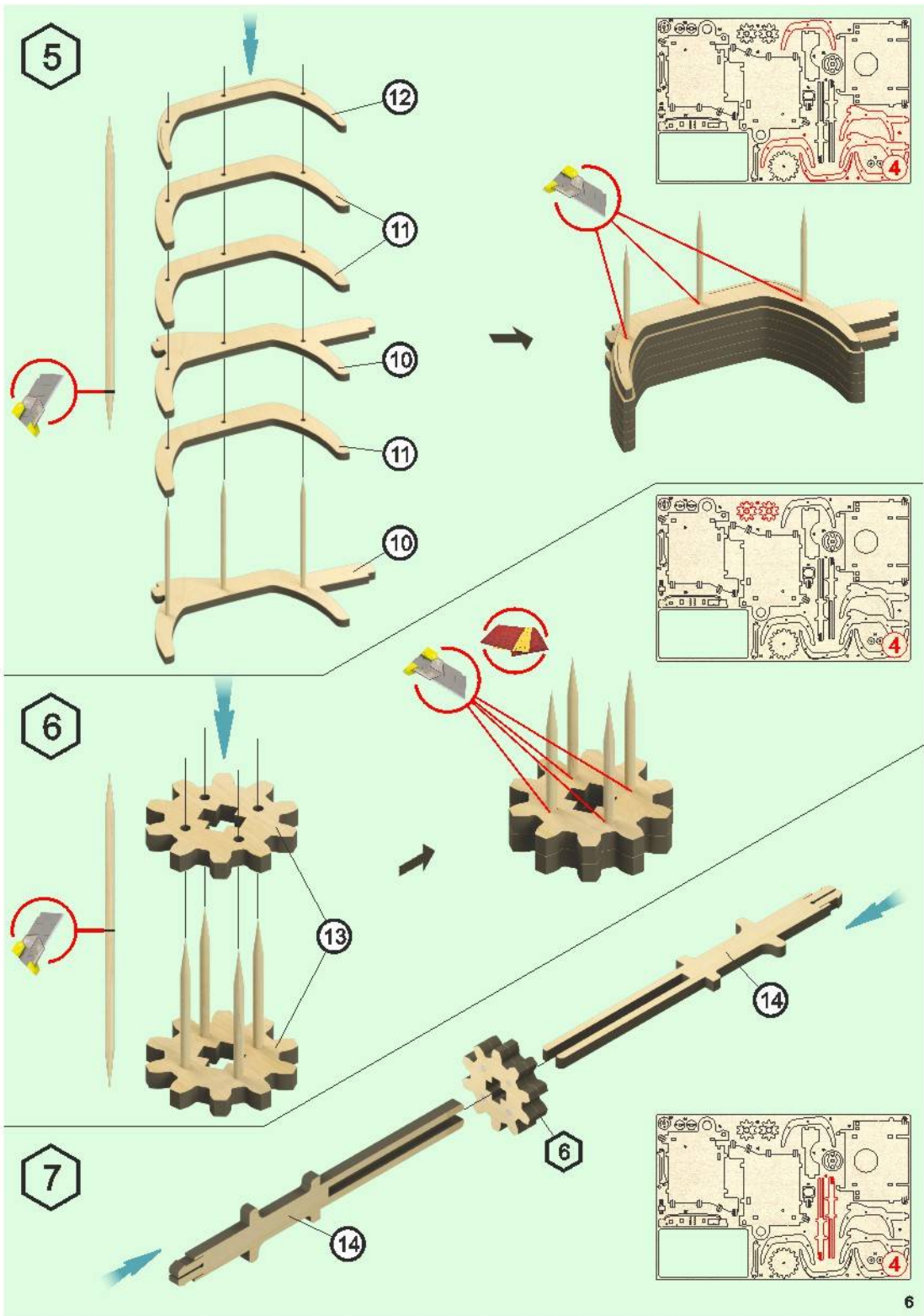
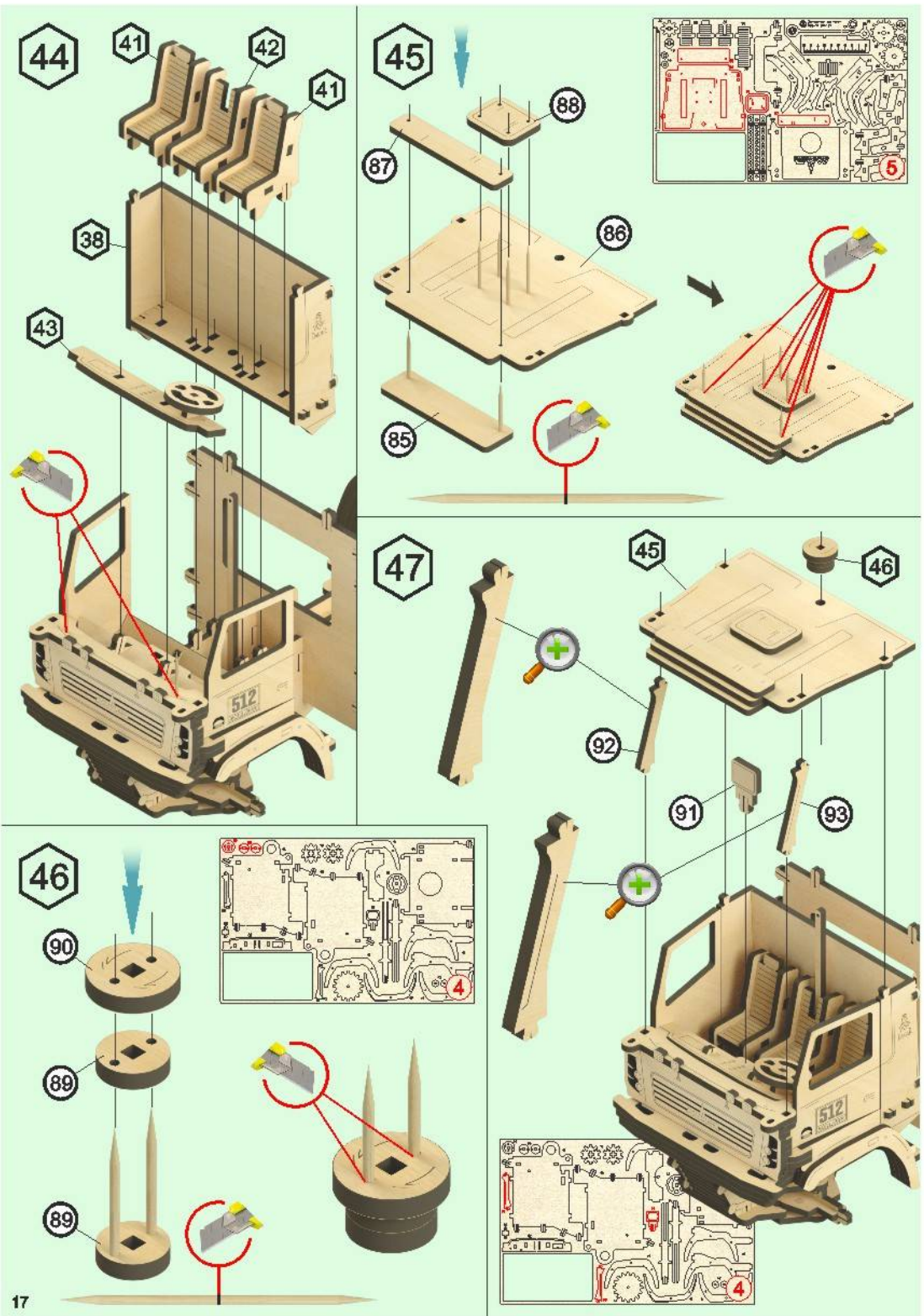

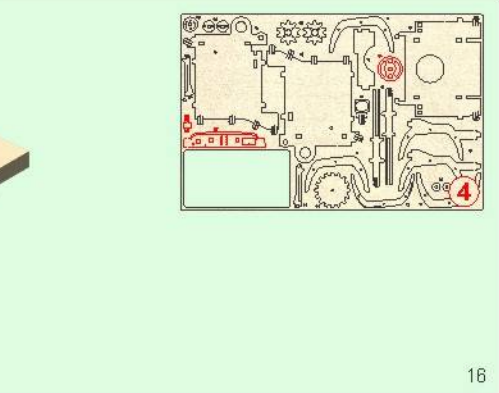
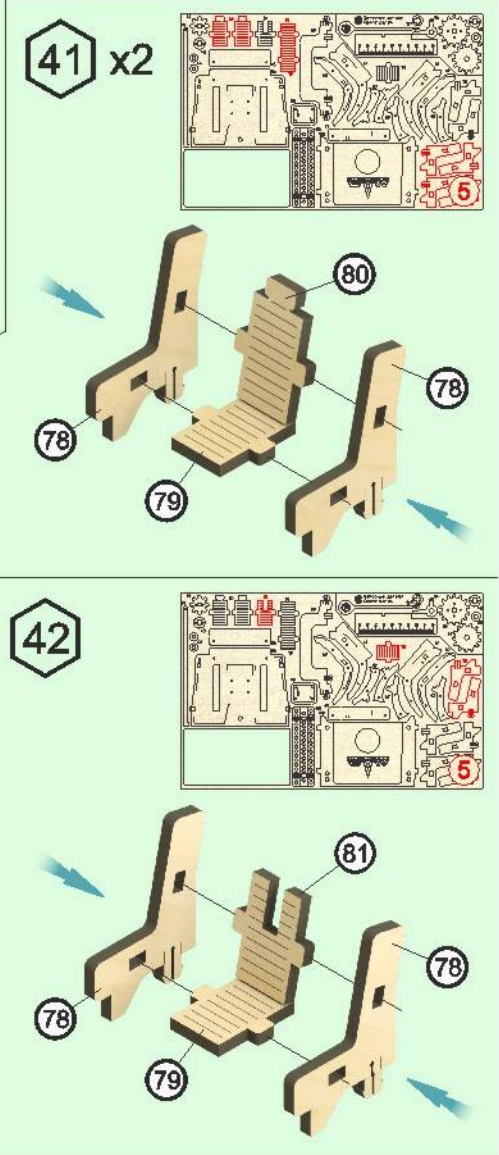
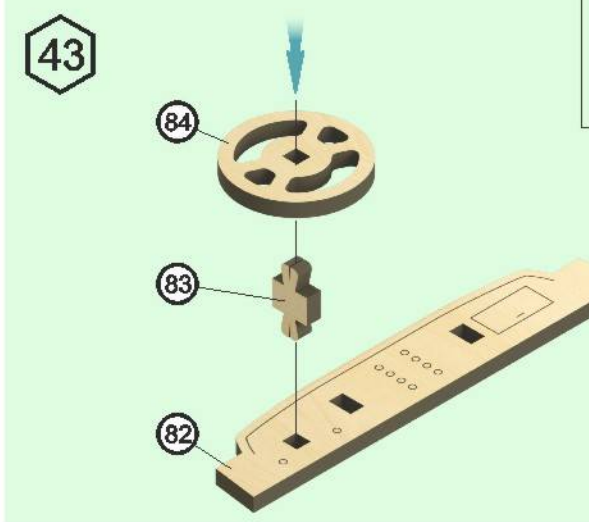
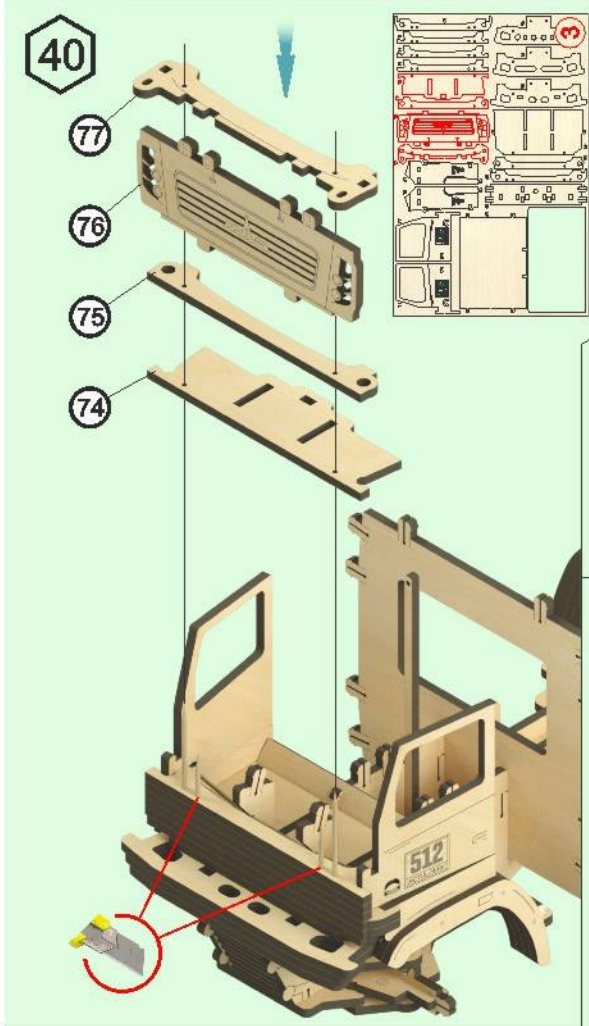
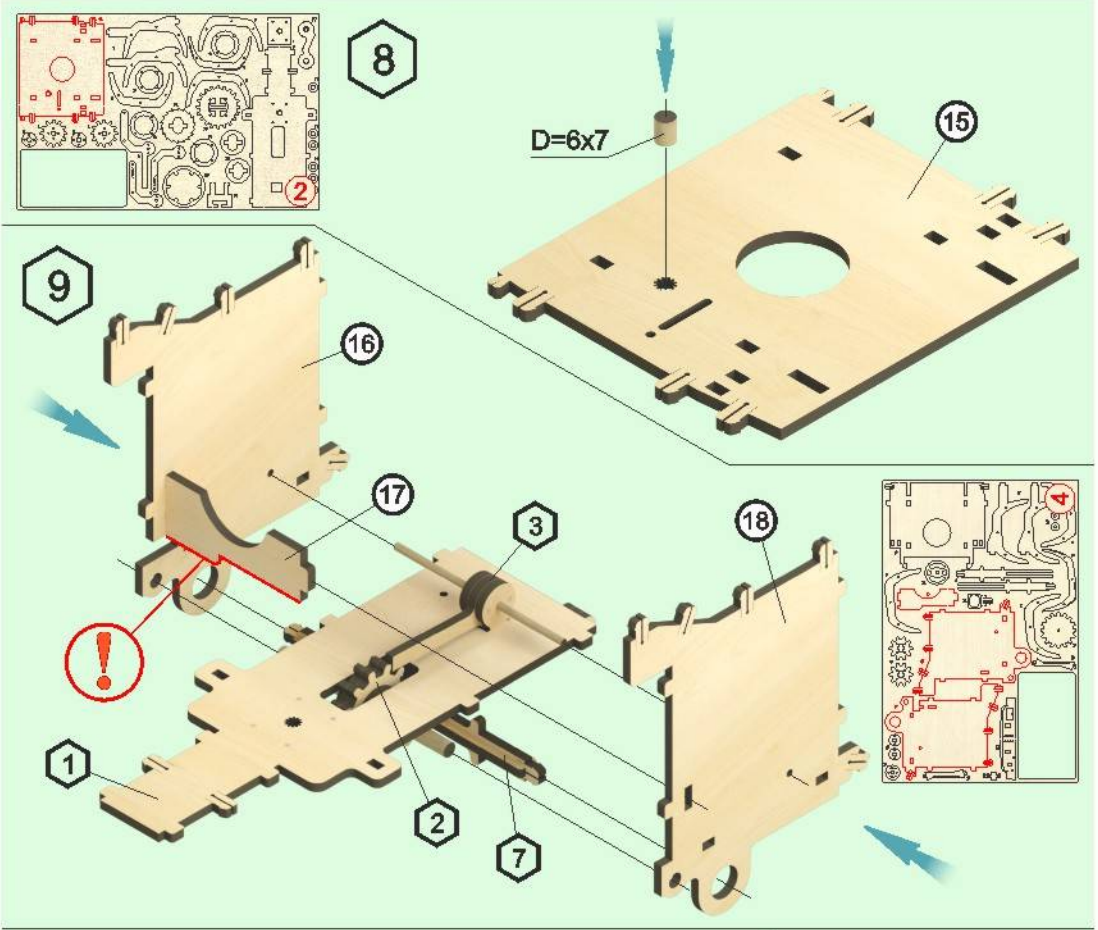

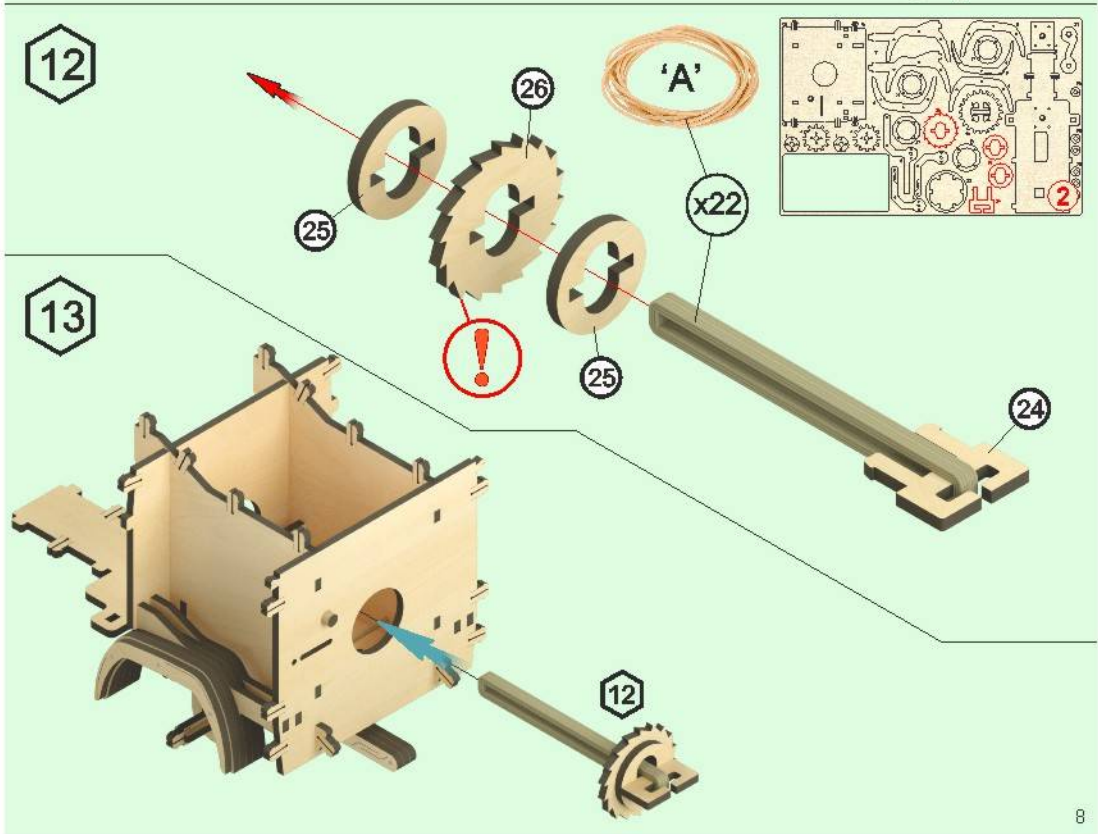
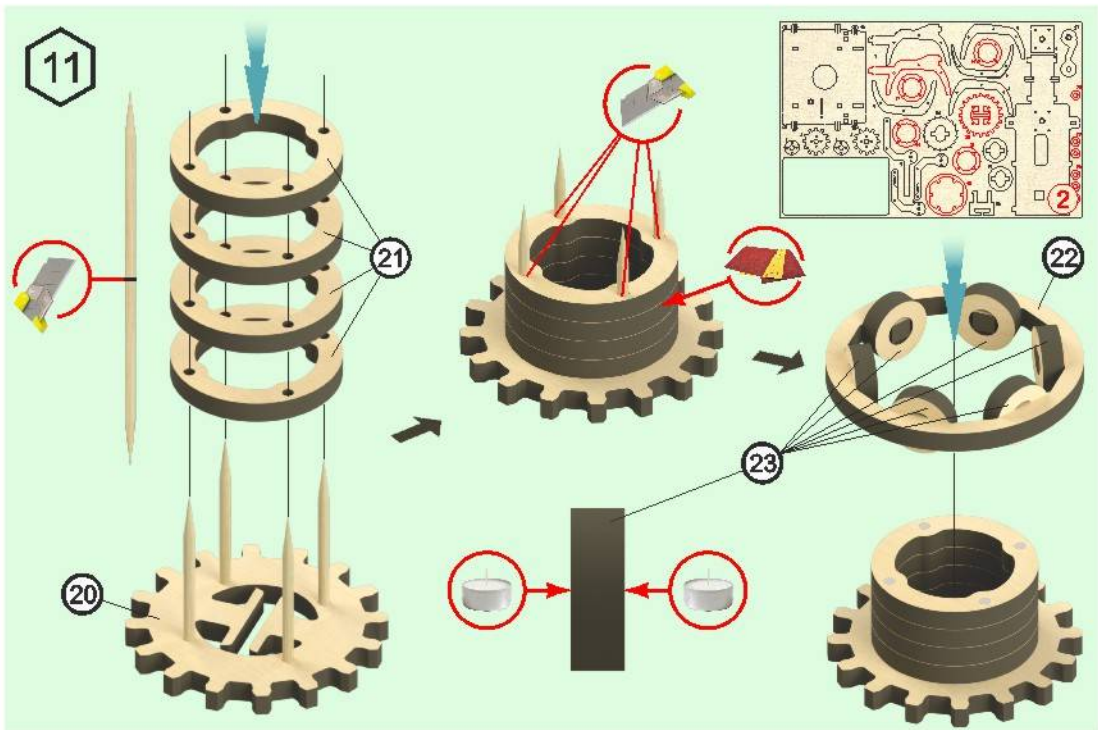
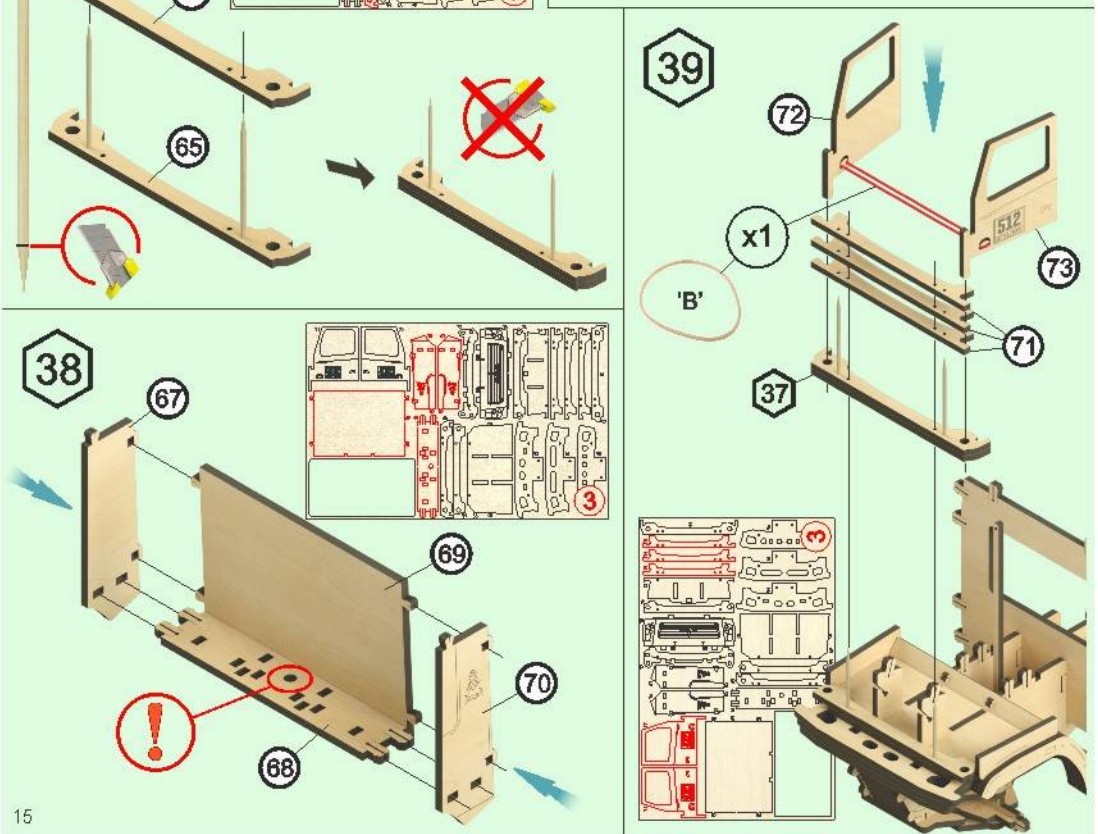
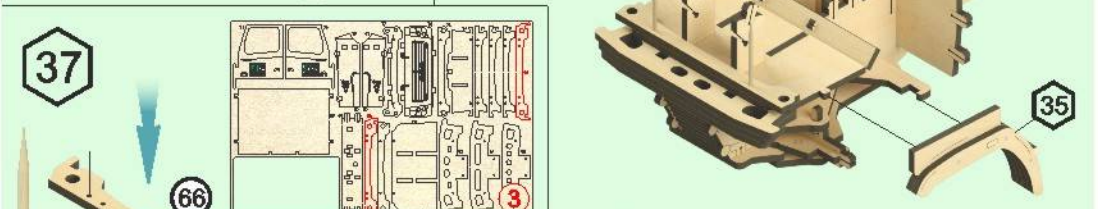
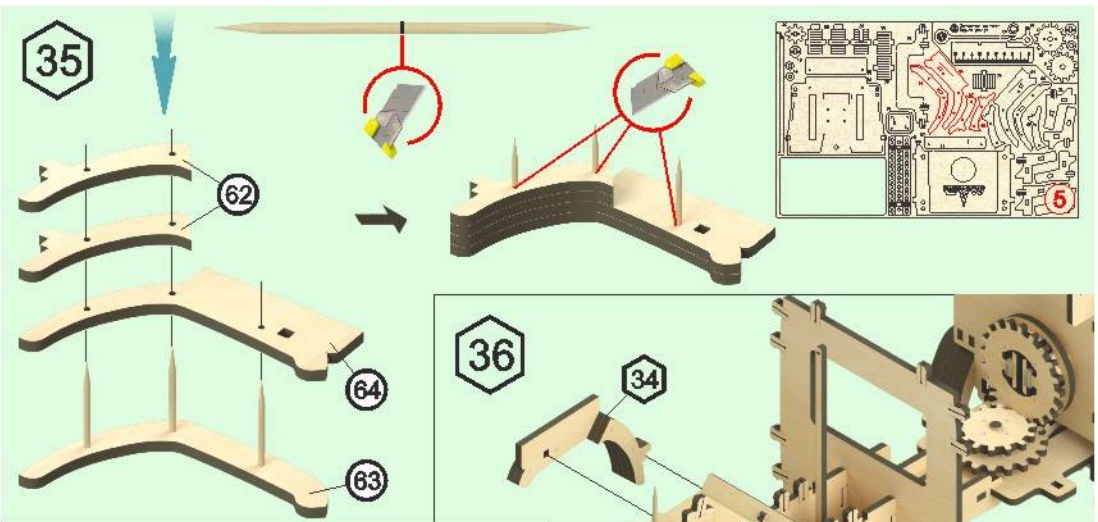

14

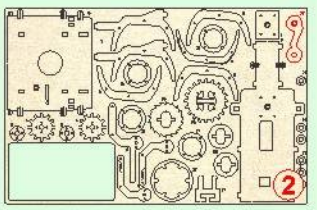
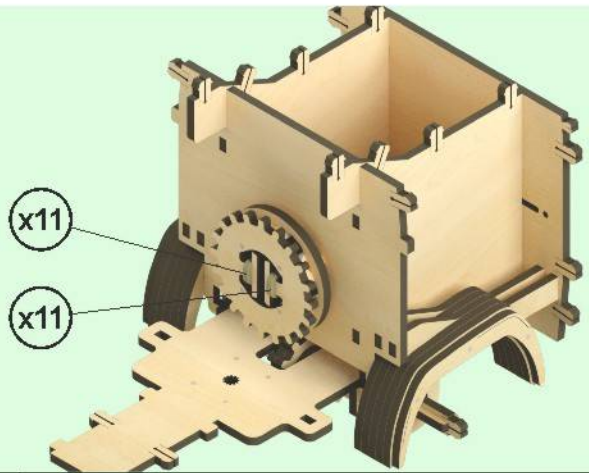
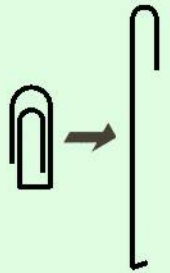

15

D=6x7

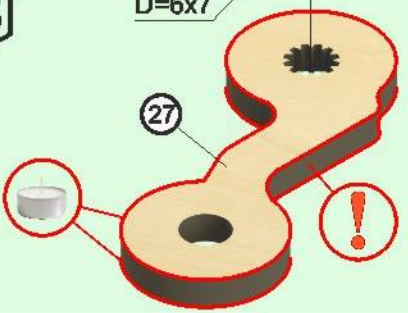

16

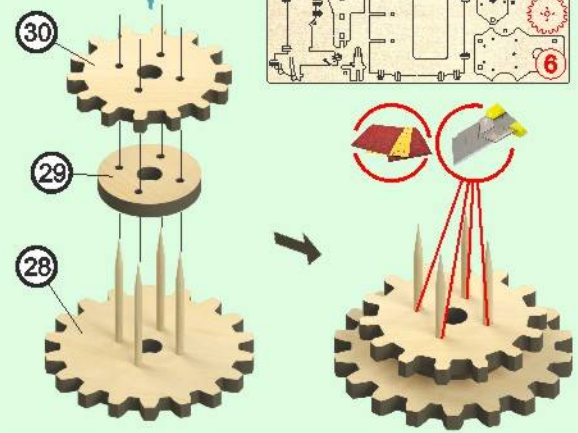

17

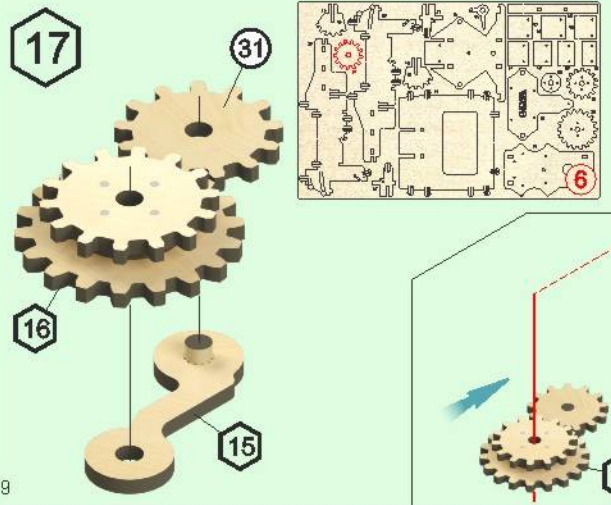

18

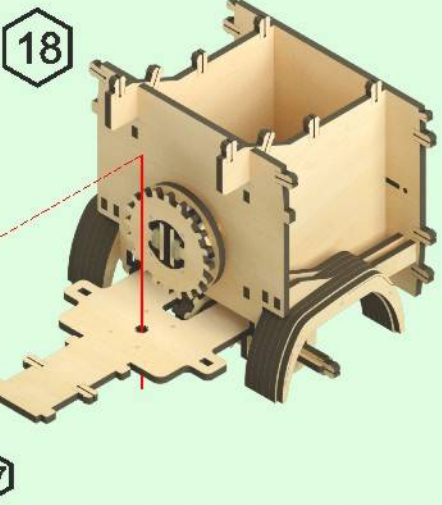

32

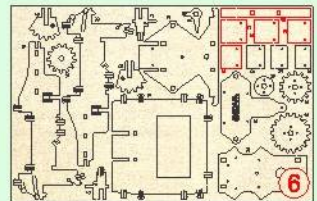
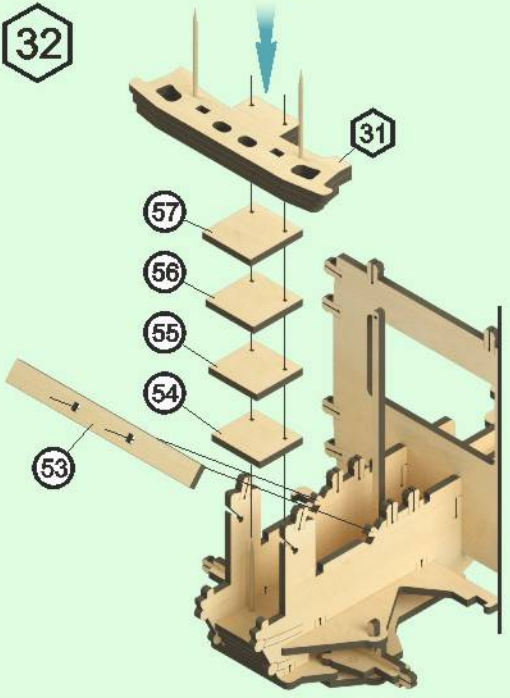

33

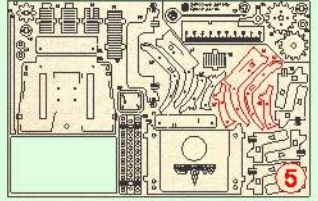
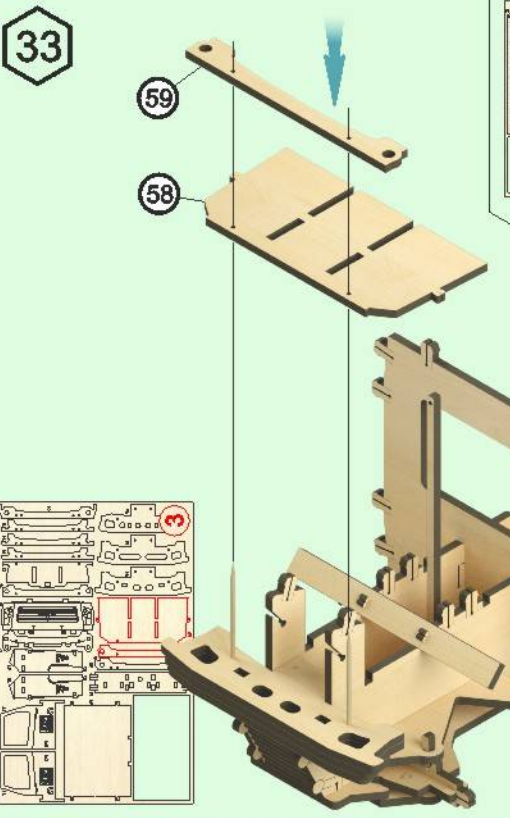

34

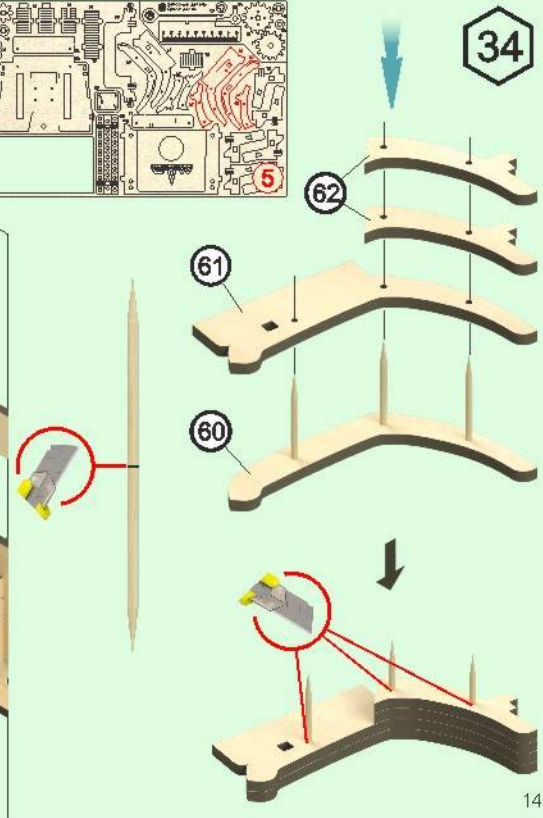

29

'B' x2

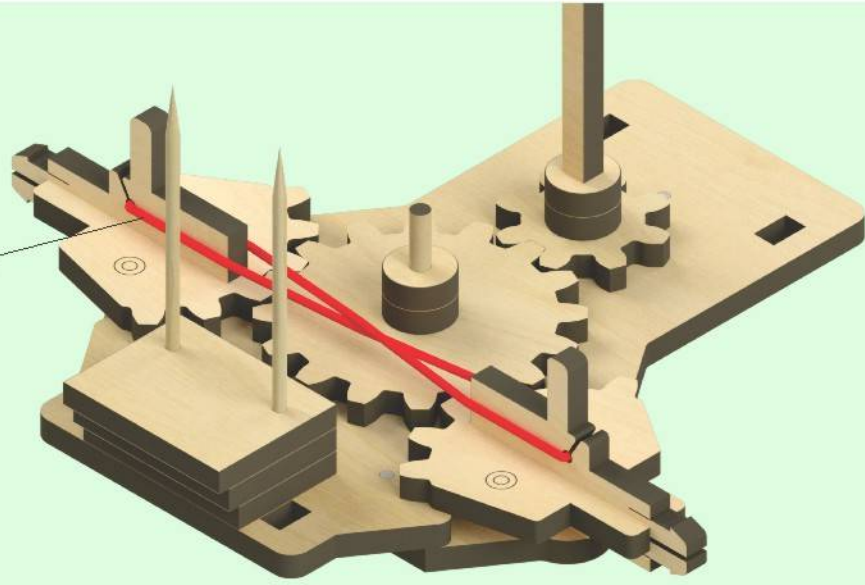

19

D=6x24

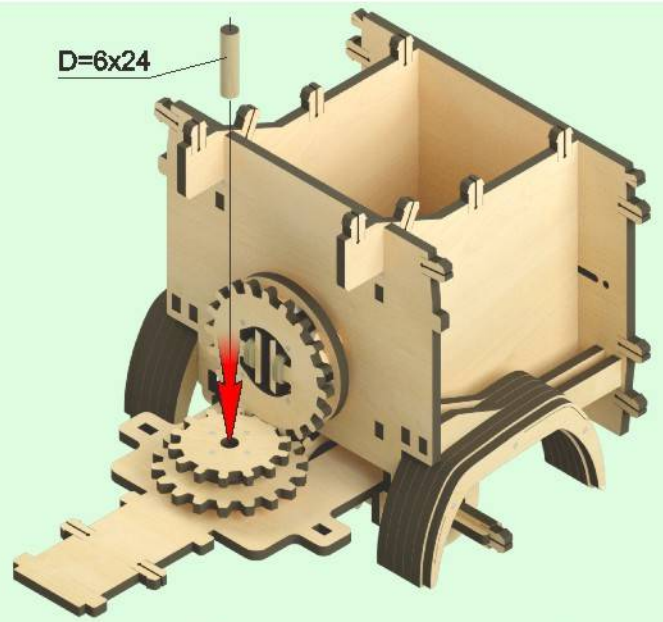

30

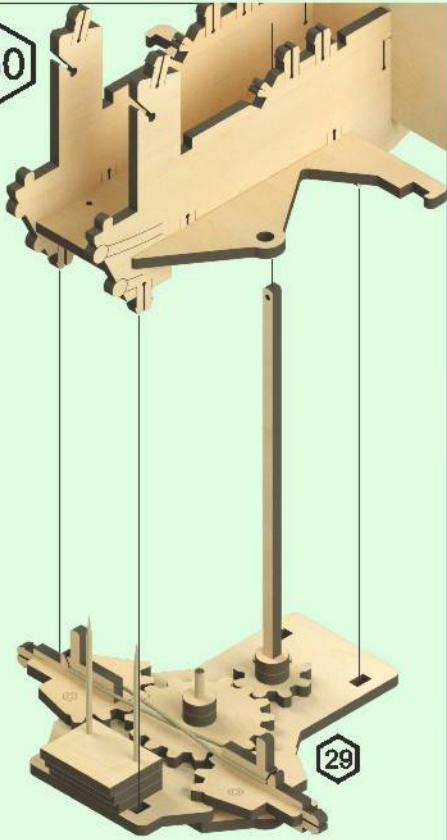

31

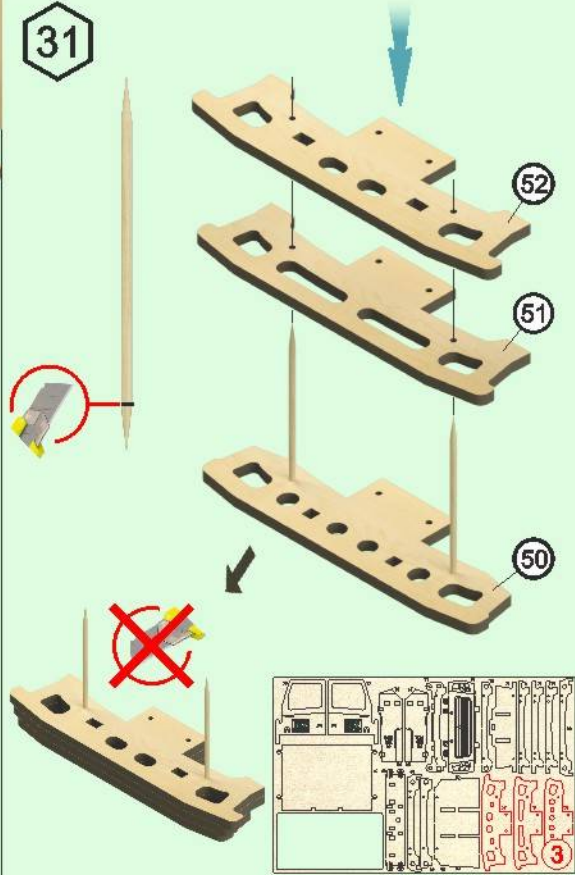

20

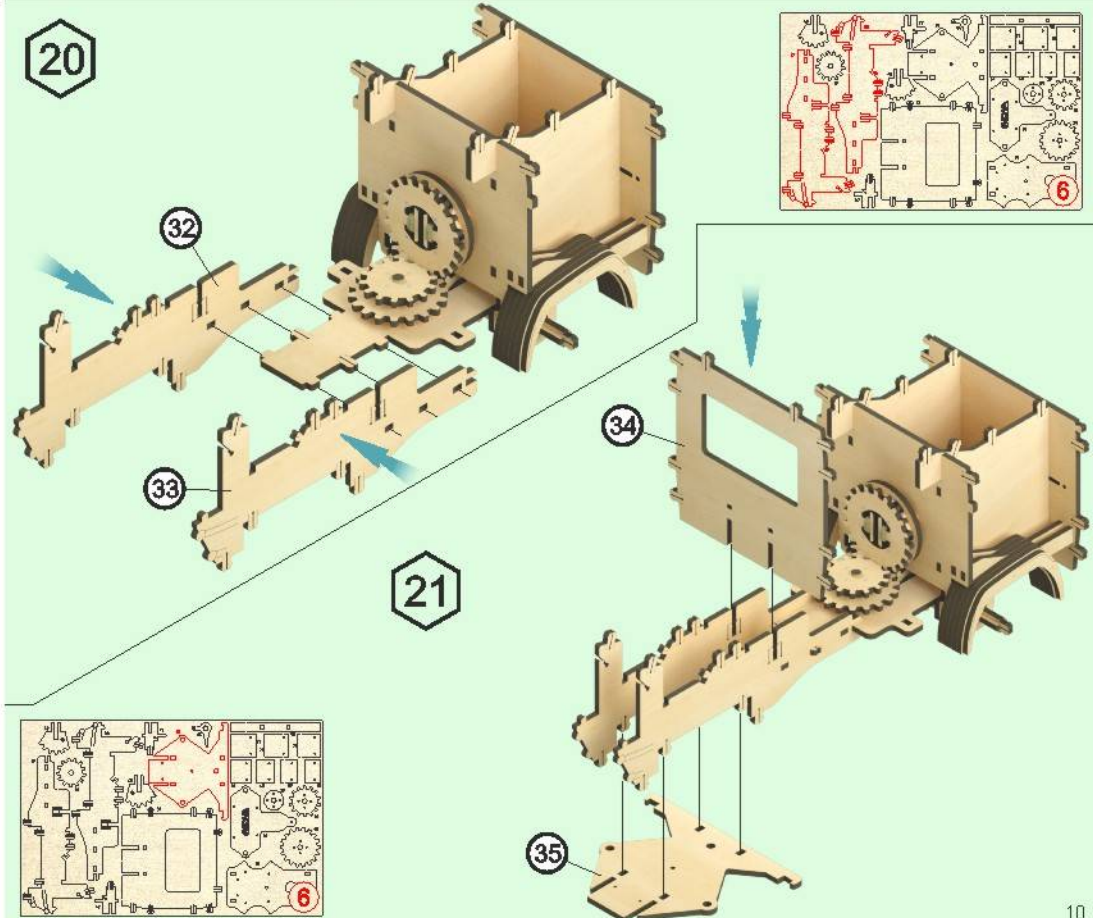

21

