

58

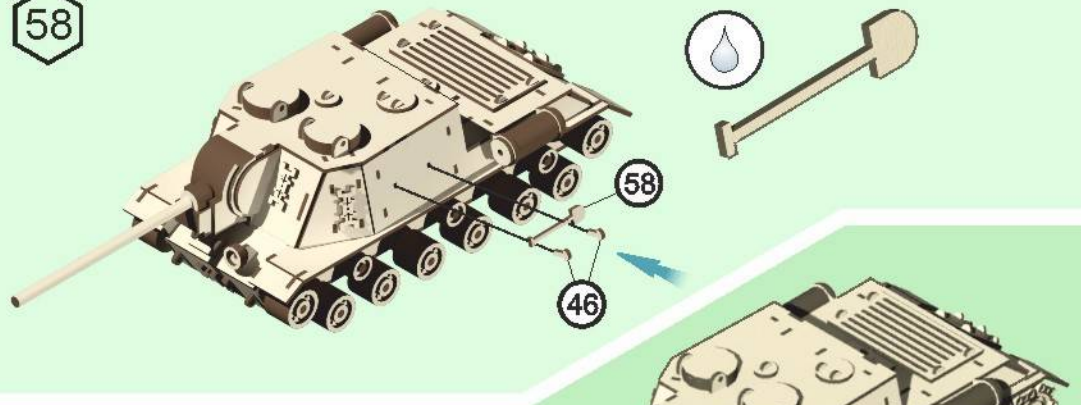

59

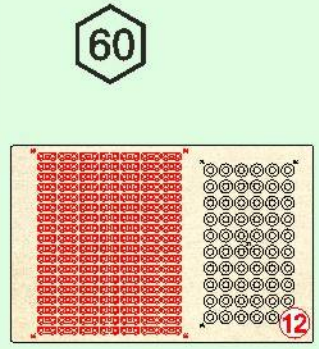
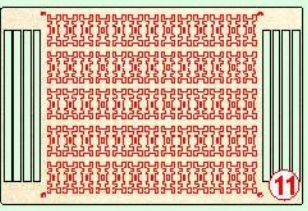
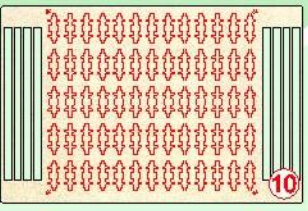
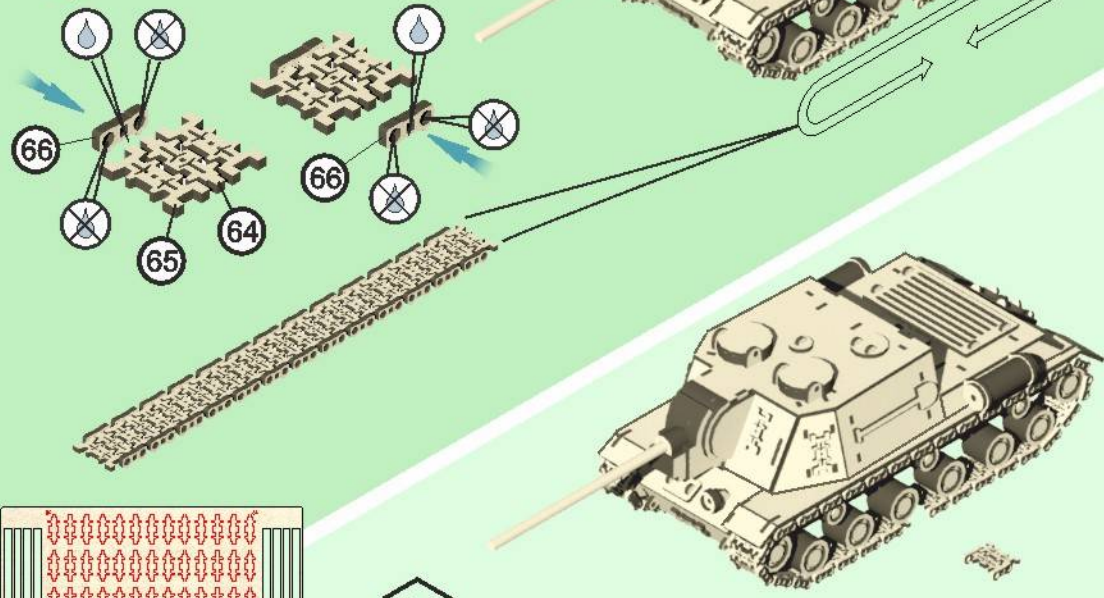

60

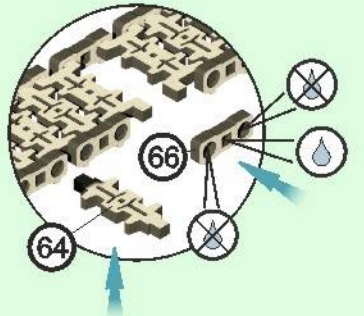

Инструкция

по сборке модели "ISU 152".
Assembly instruction for model "ISU 152"
Le istruzioni per il montaggio del modello "ISU 152"

Для сборки необходимо использовать любой клей для дерева!
For the assembly you can use any wood glue!
Per il montaggio si deve utilizzare qualsiasi colla per legno

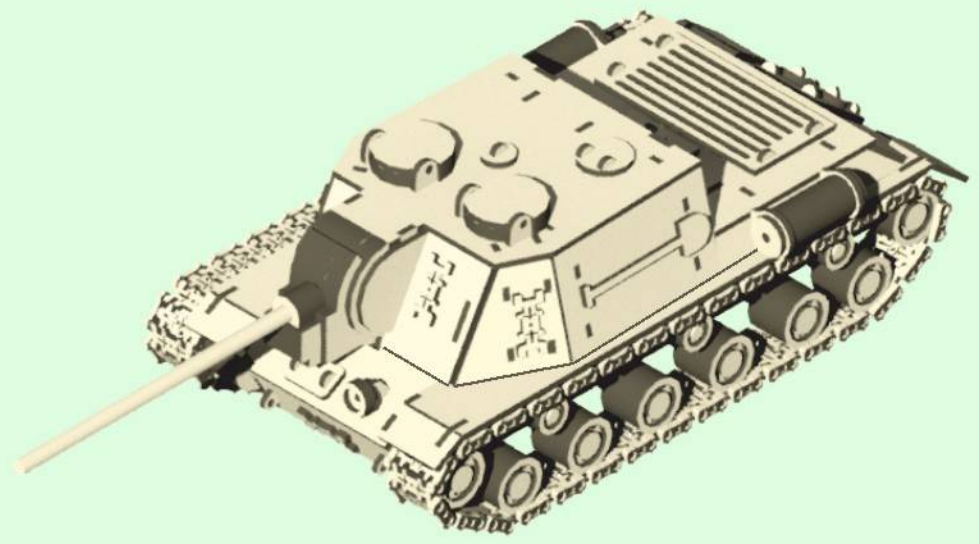

Использовать клей/ use glue/ usare colla



Не использовать клей/ do not use glue/ non usare colla



Древесина подвержена воздействию влаги. Для лучшего соединения/входа деталей использовать свечку, канцелярский нож, наждачную бумагу или подсушить изделие!
Wood exposed to moisture. For the best connection/ogin details to use a candle, a box cutter, sandpaper, or dry the product!
Il legno è esposto ad umidità. Per una migliore connessione/Inserimento dei dettagli si deve utilizzare candela, coltello di cancelleria, carta abrasiva o far asciugare il prodotto



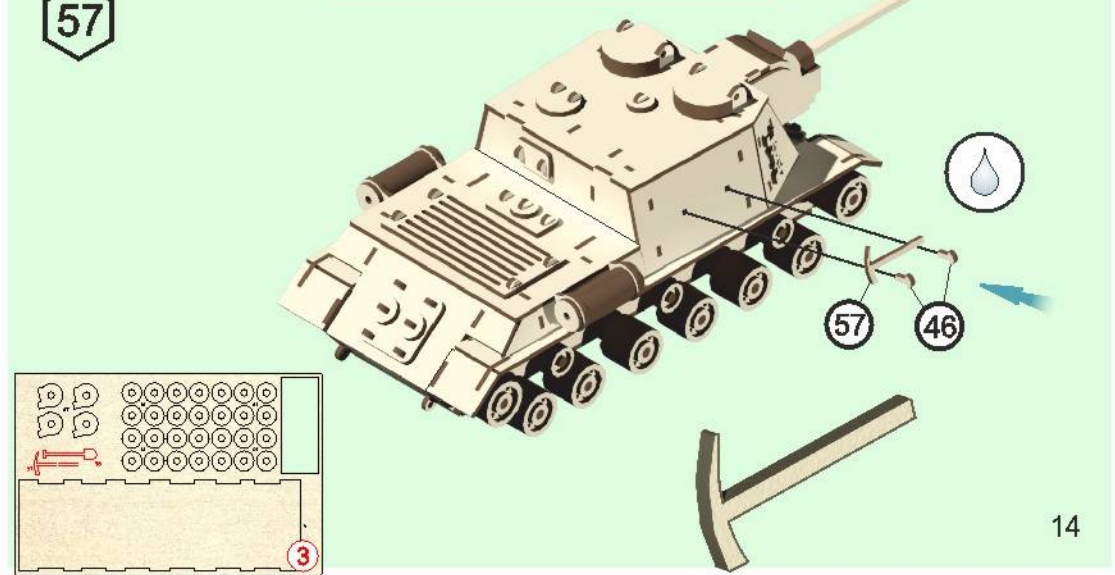
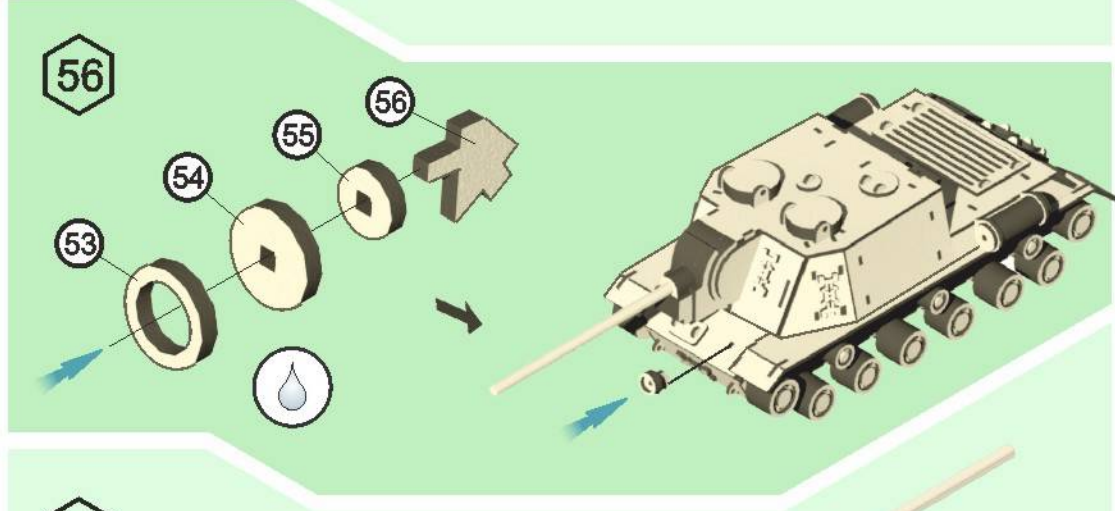
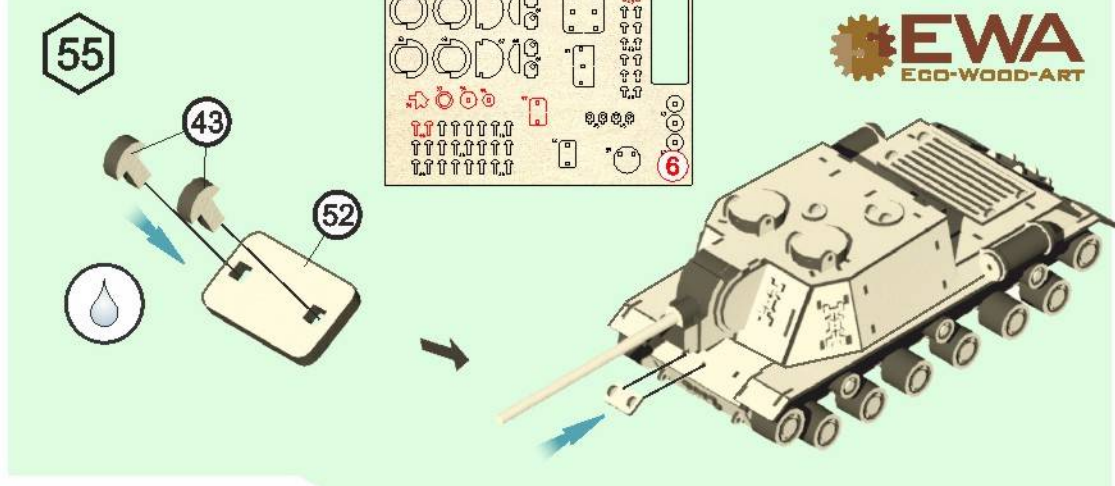
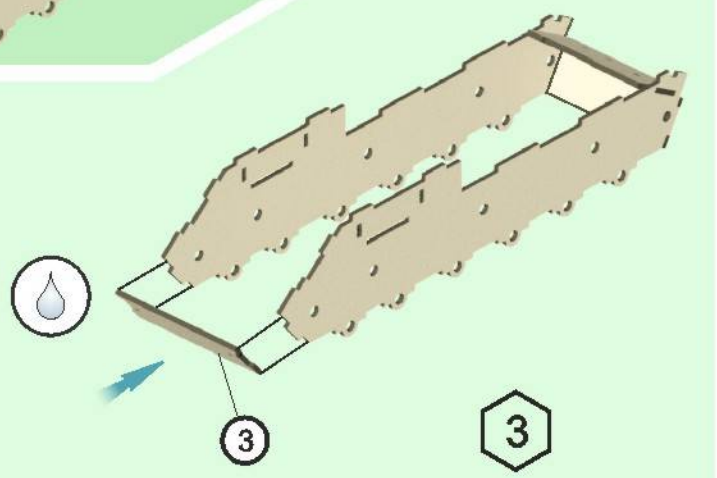
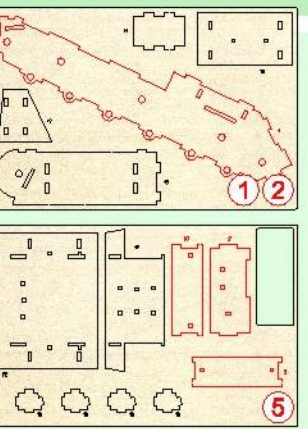
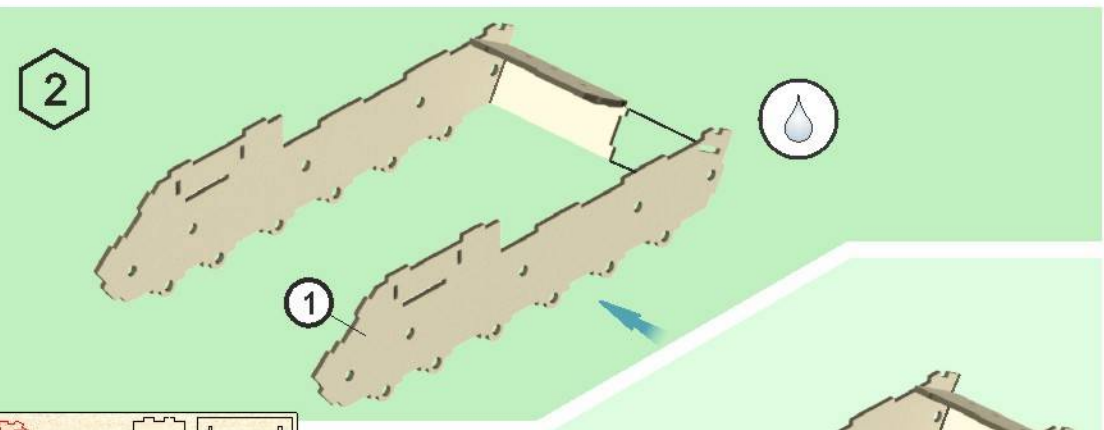
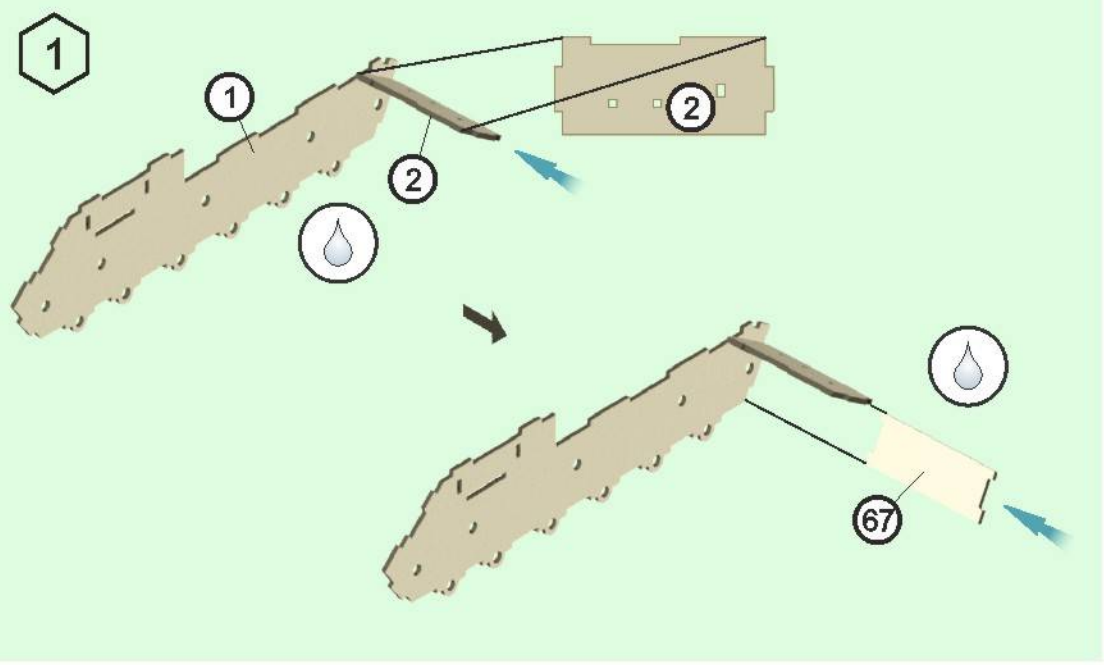

52

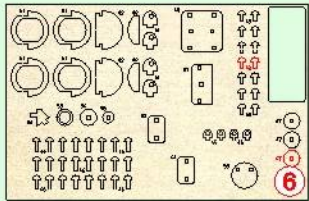
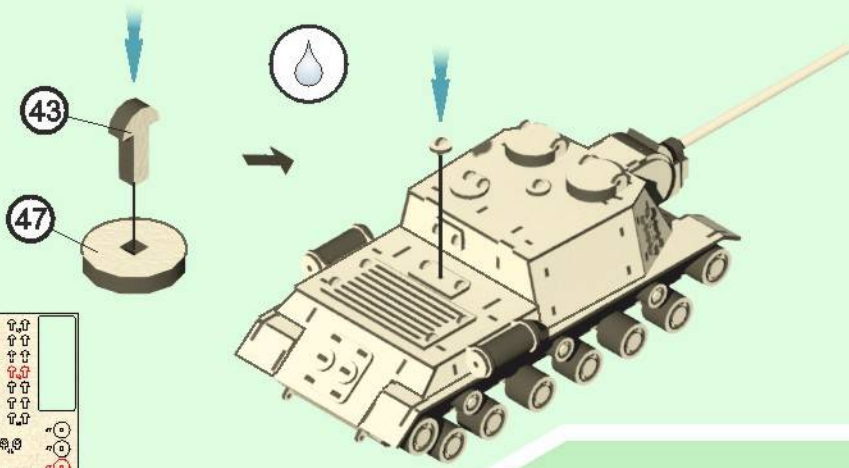

53

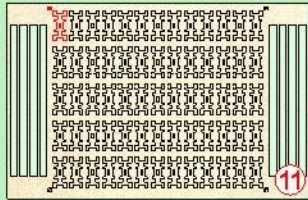
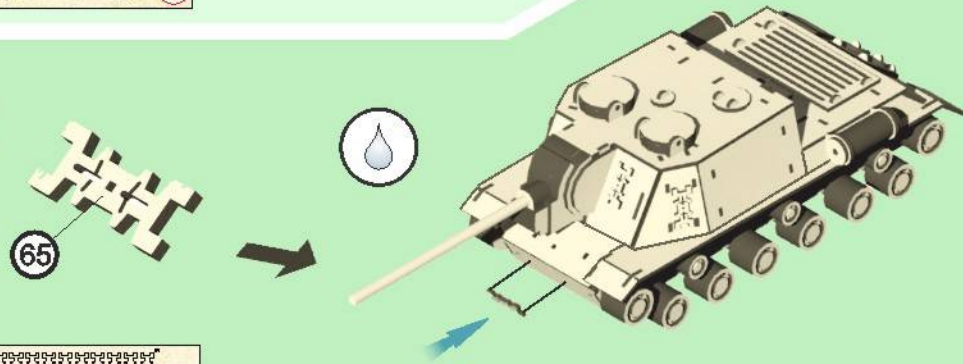

54

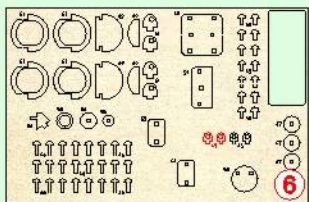
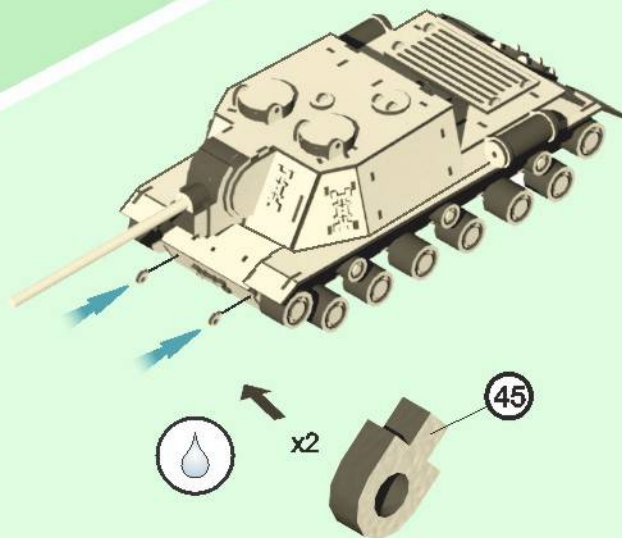

4

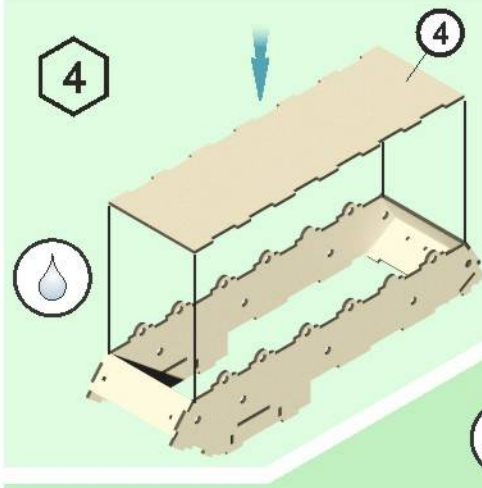

5

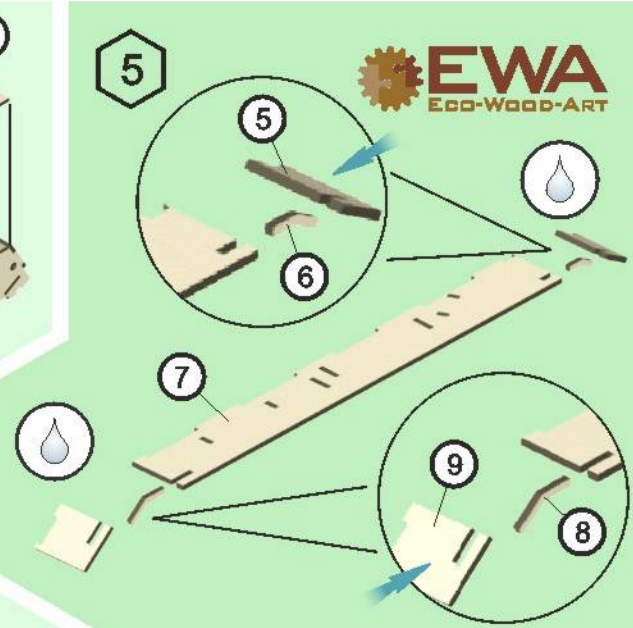

EWA
ECO-WOOD-ART

6



7

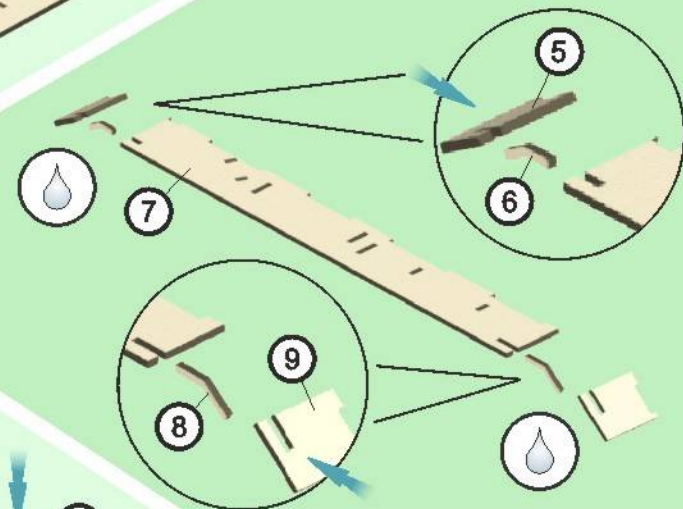

8

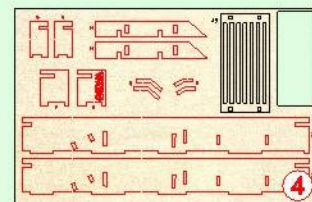
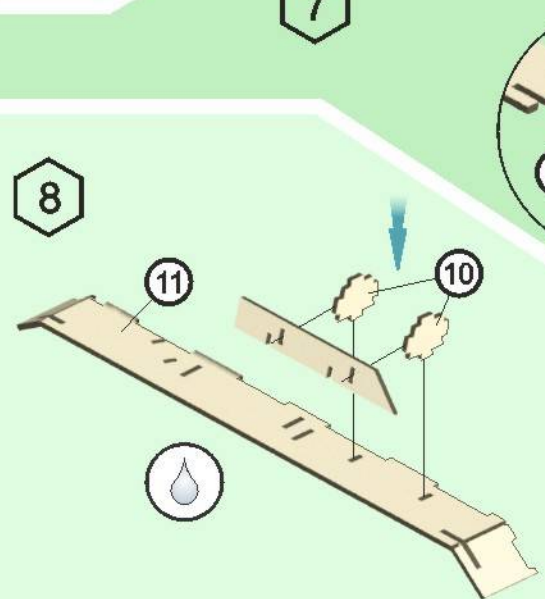

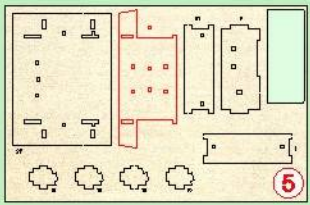

9

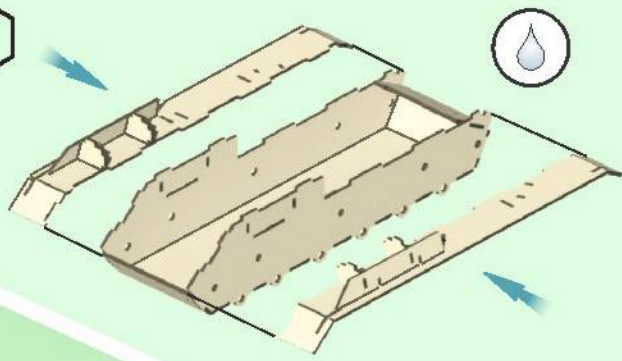

10

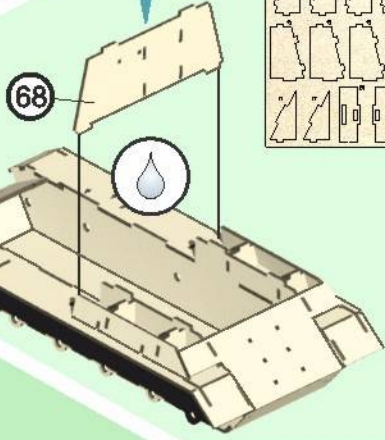
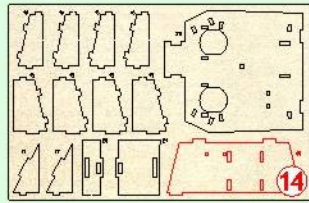
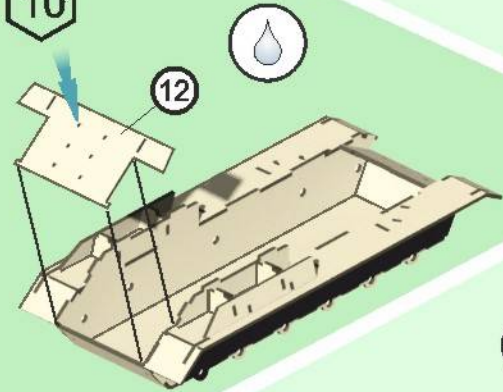

11

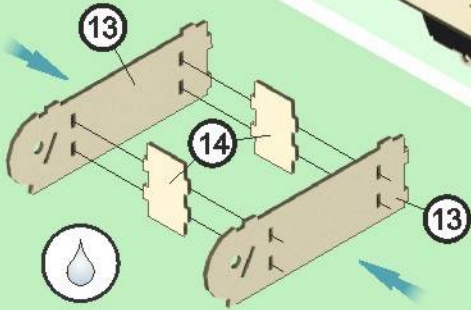

12

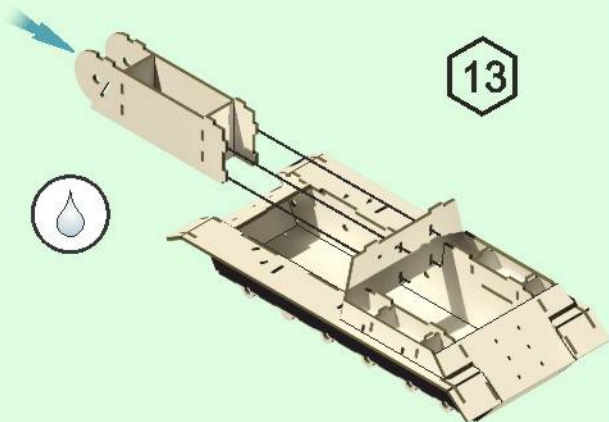
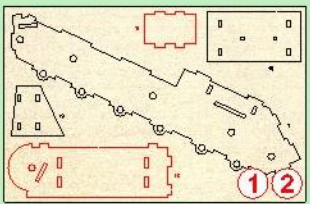

13

49

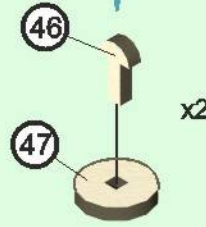

x2

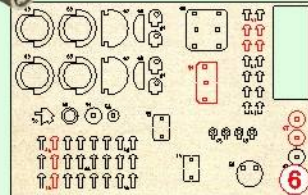
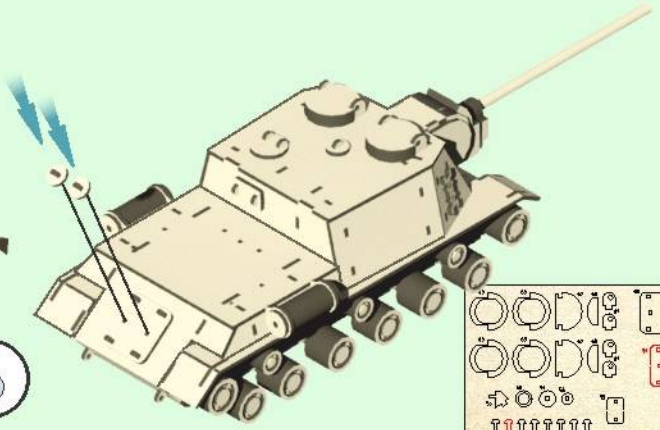

6

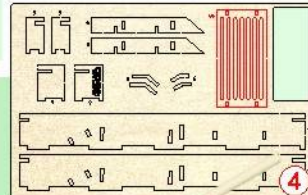

4

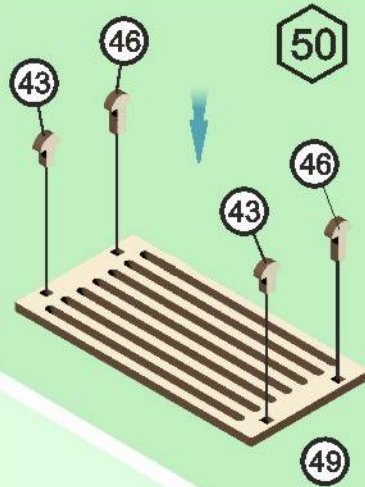

50

51

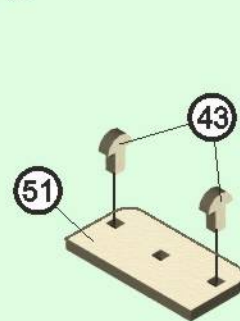

51

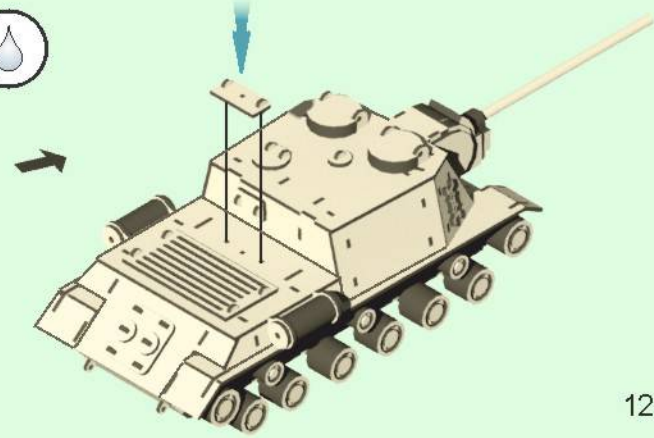

46

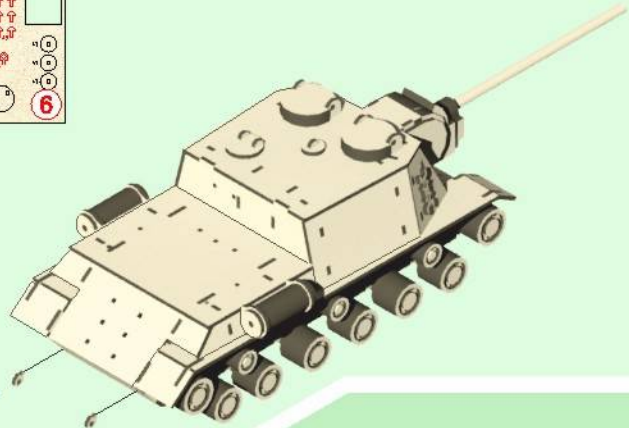
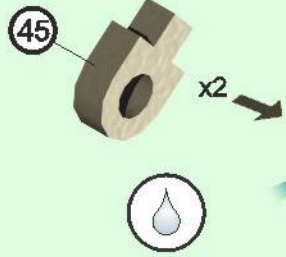
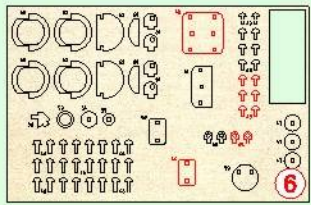

47

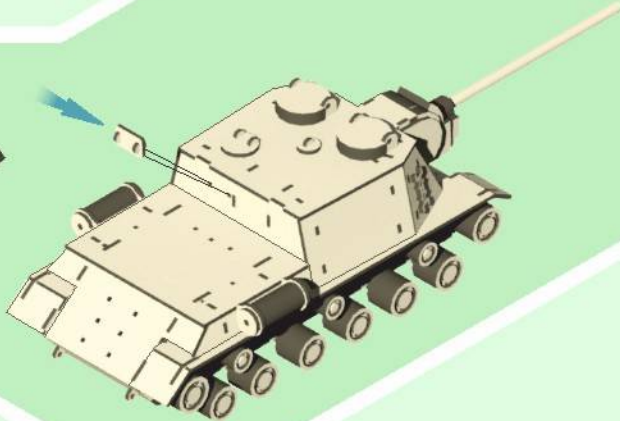
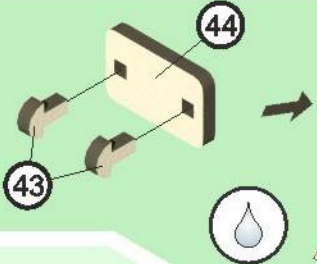

48

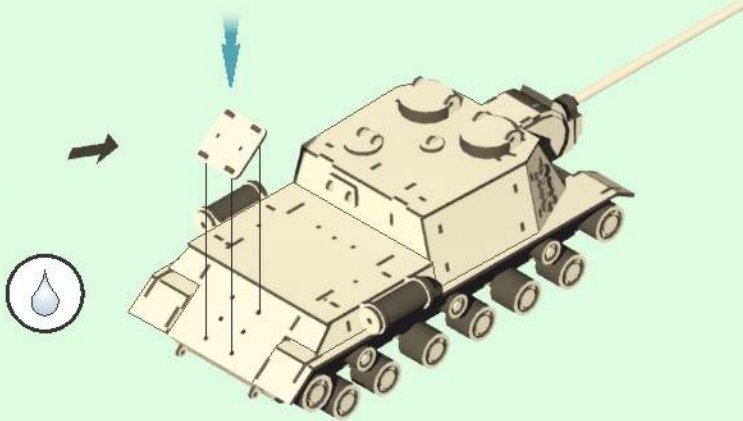
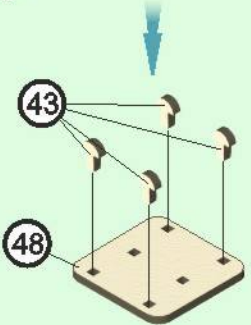

14

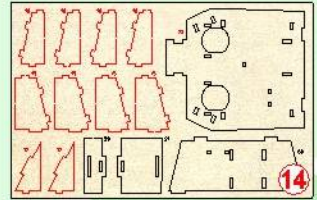
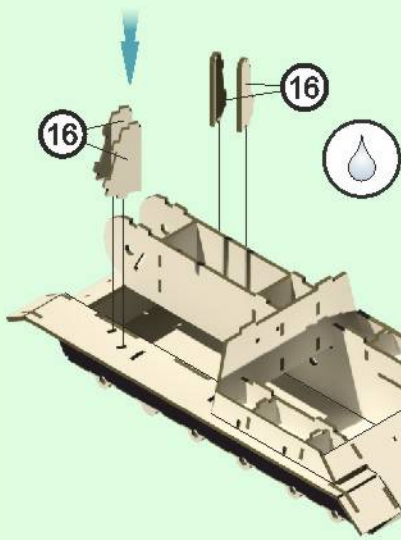

15

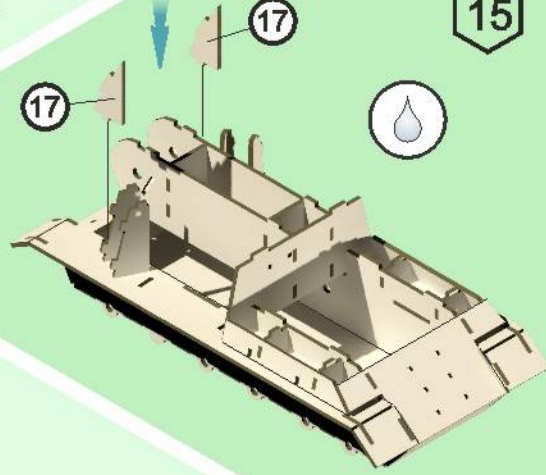

16

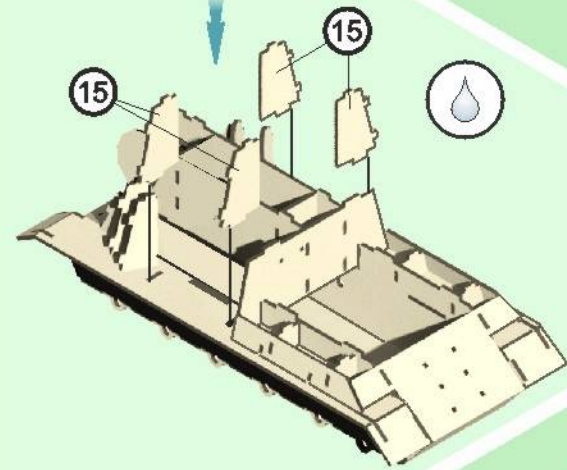

17

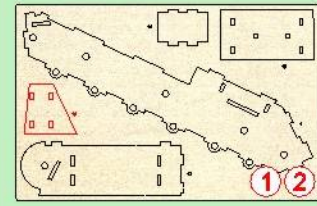
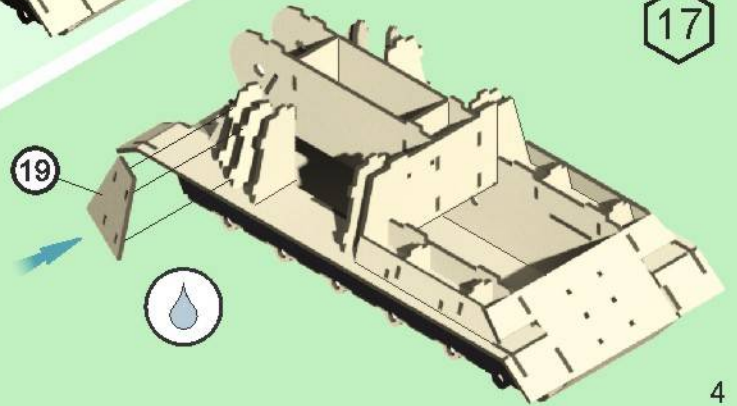

18

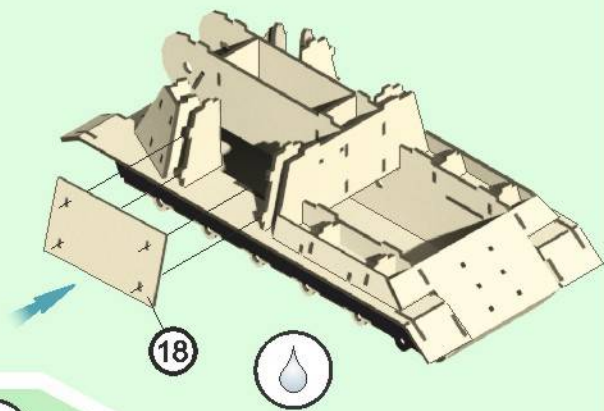
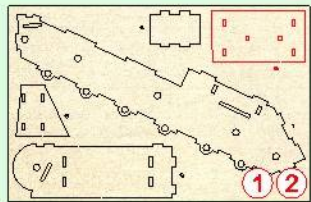

19

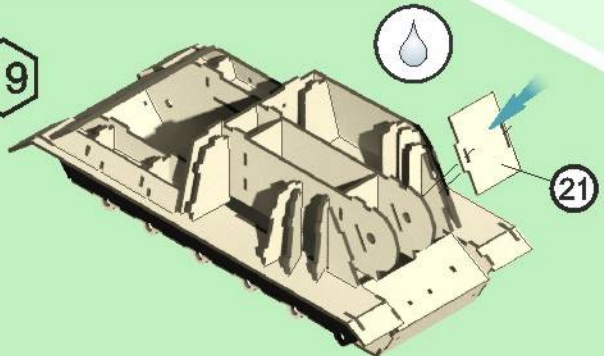

20

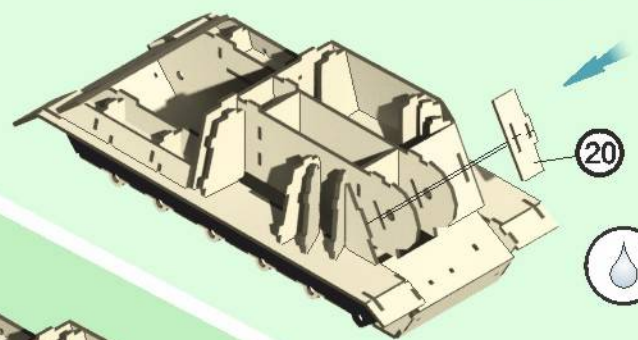

21

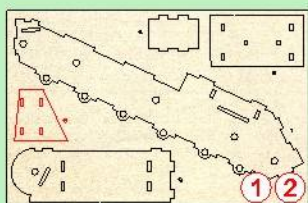
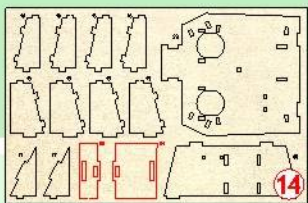
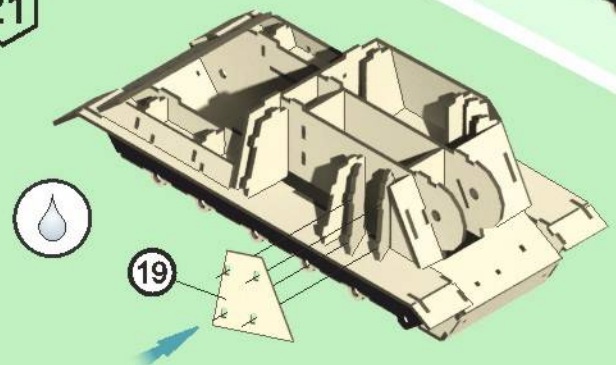

42

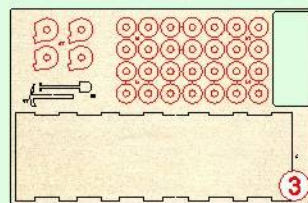
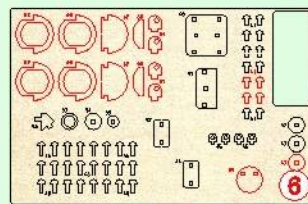
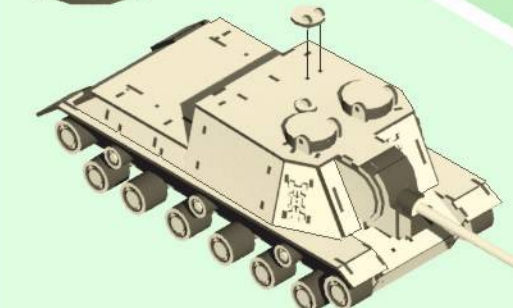
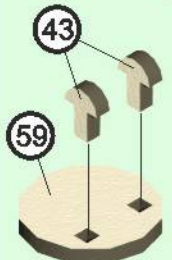
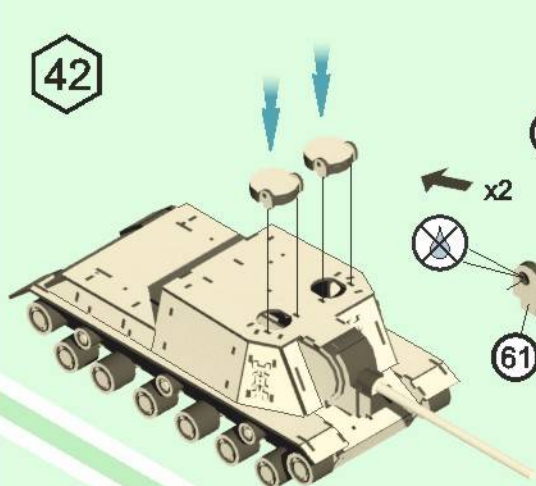

43

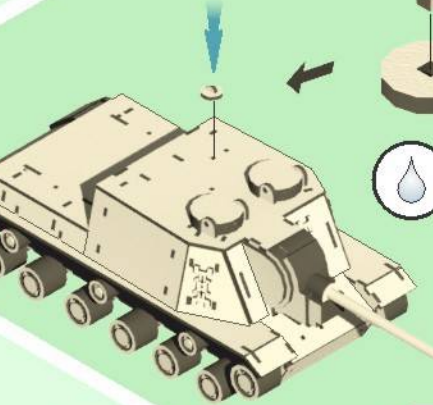
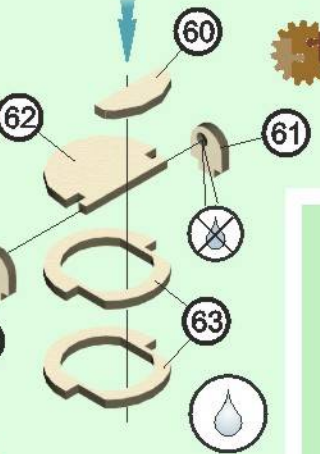

44

45

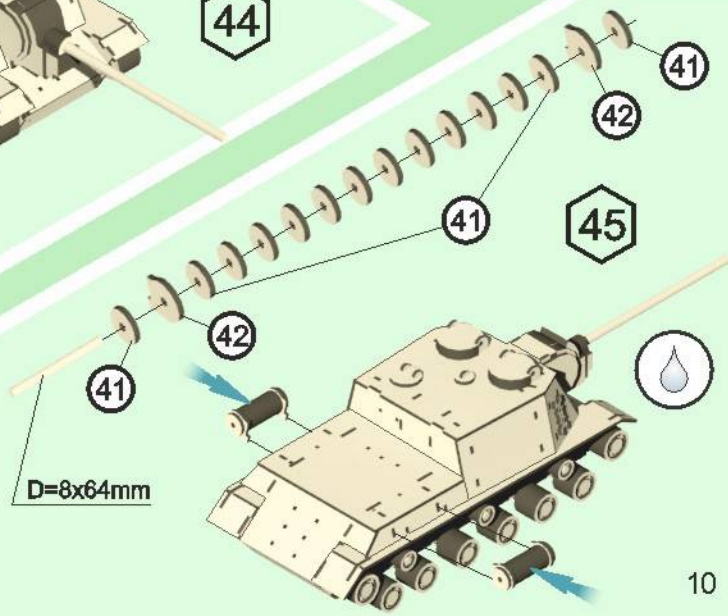

D=8x64mm

38

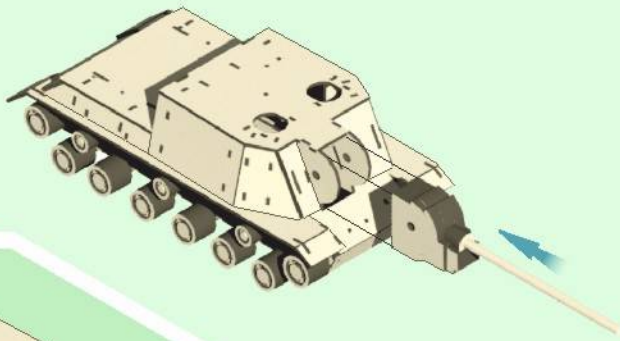

39

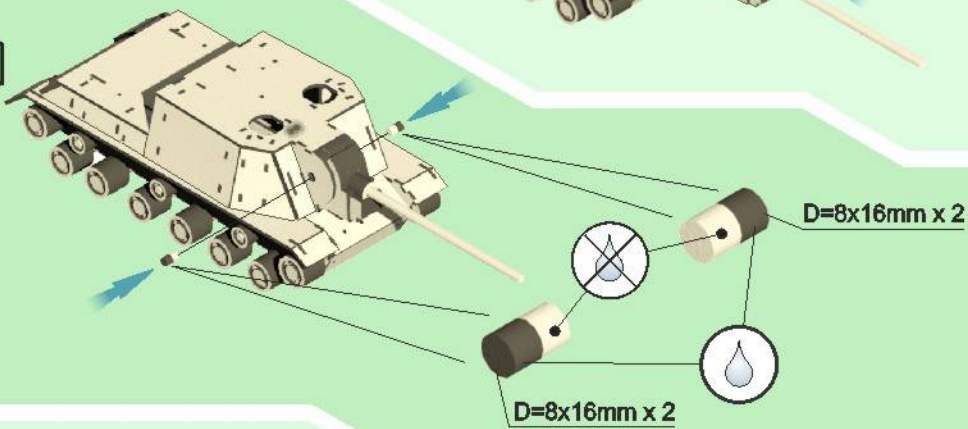

40

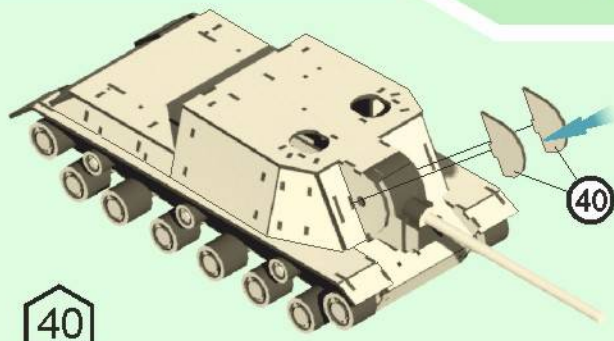

41

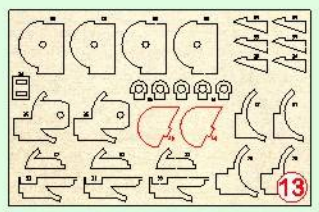
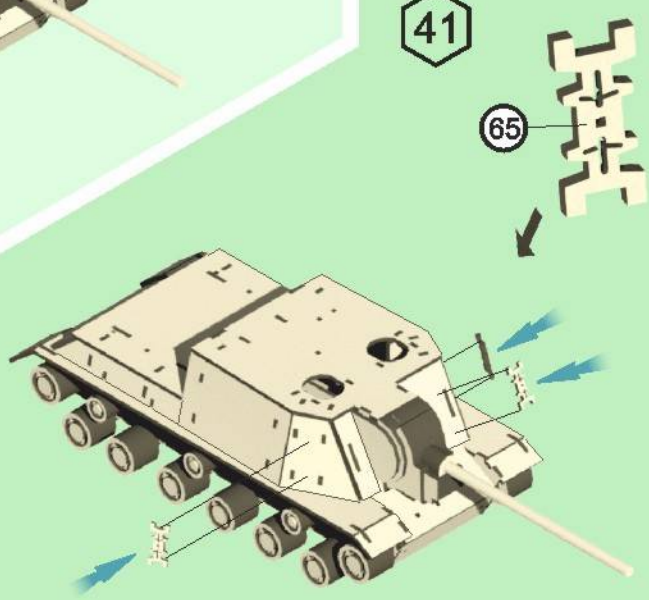

13

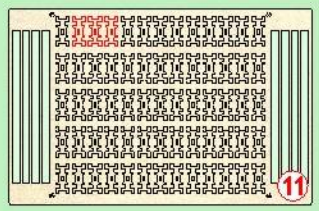

11

9

22

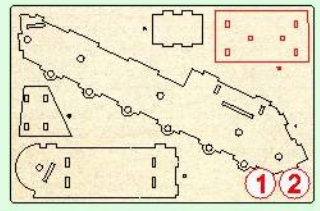
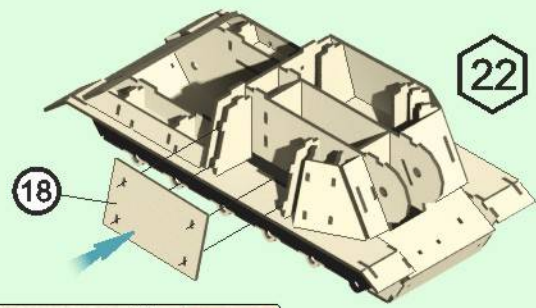

1 2

23

EWA
ECO-WOOD-ART

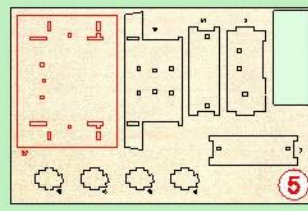

5

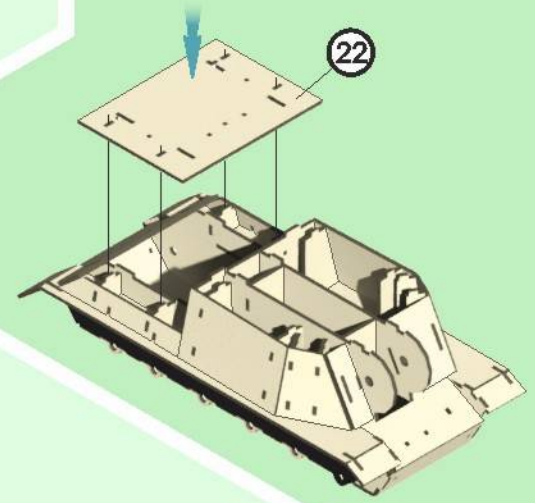

24

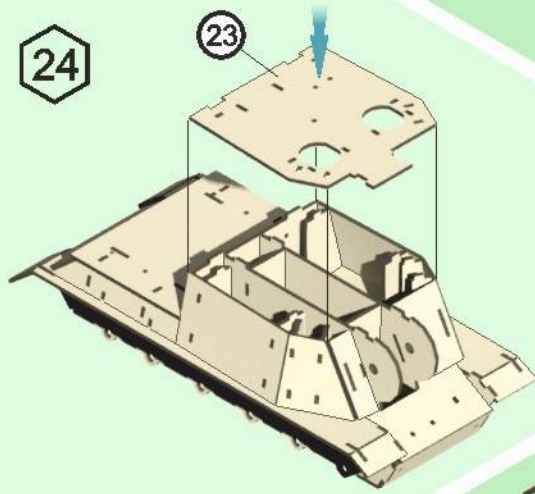

25

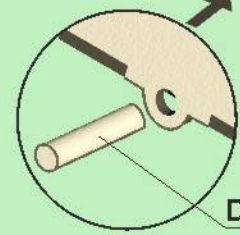
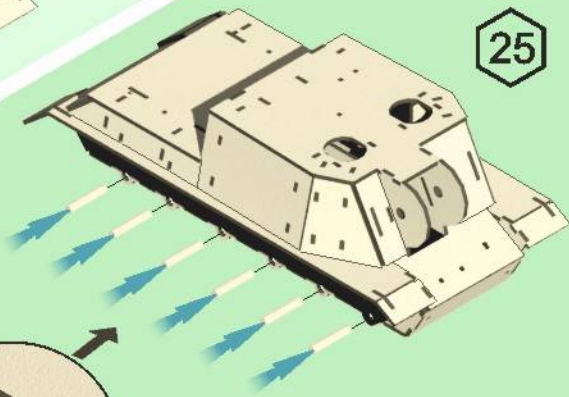

D=8x40mm x 6

6

