

11

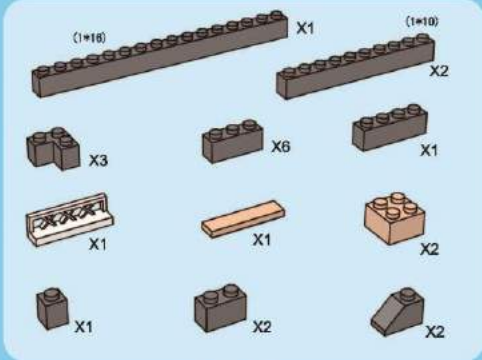

12

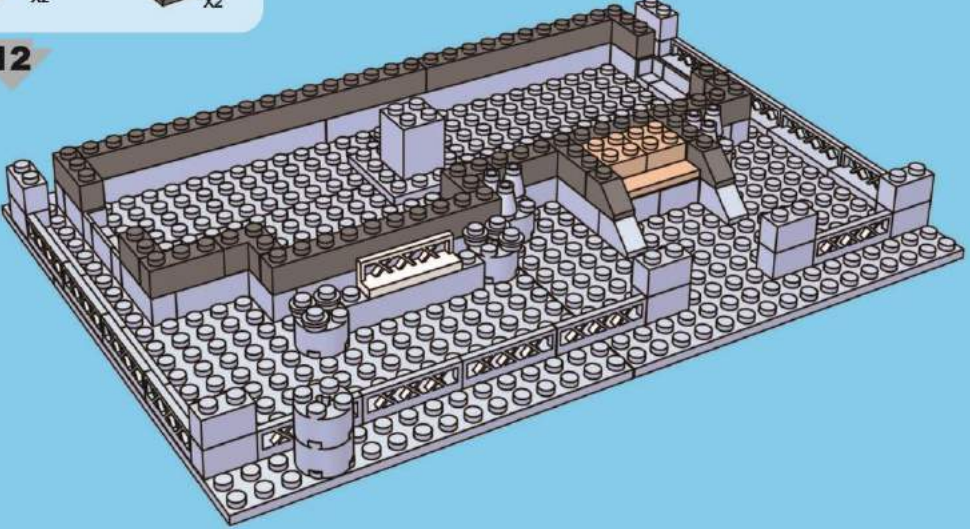

- (2x8) X1
- (1x8) X1
- X1
- X2
- X4
- X2
- X2
- X8
- X1
- X4
- X4
- X4
- X4

15

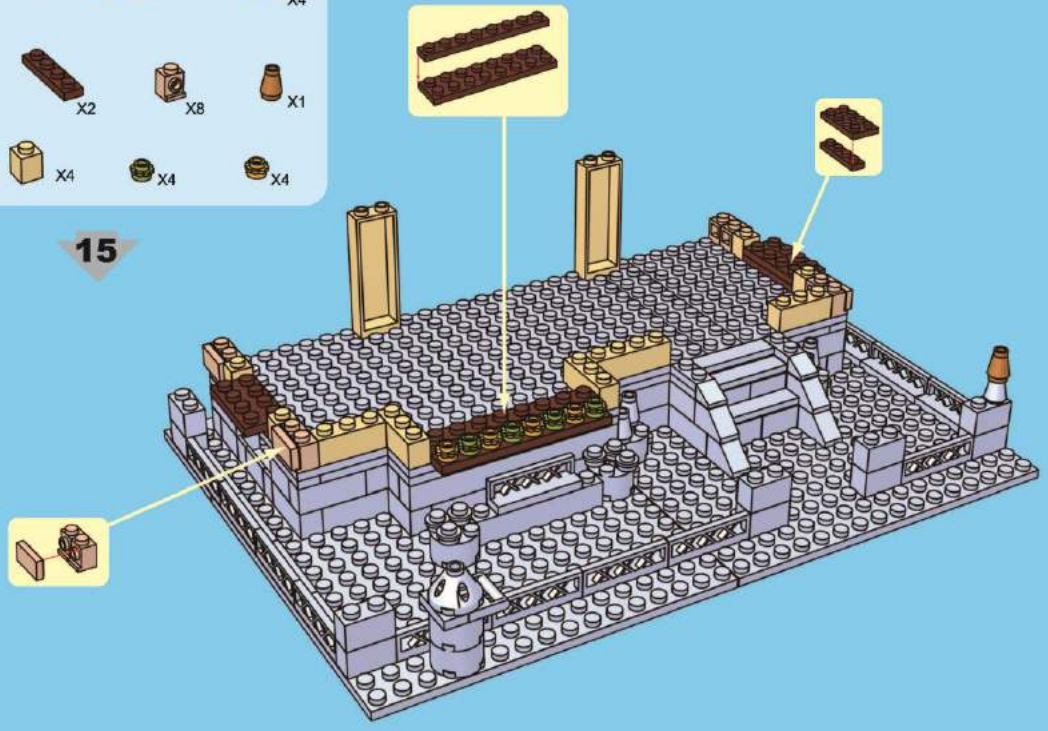

- X2
- X4
- X1
- X1
- X2
- X1
- X2
- X6

16

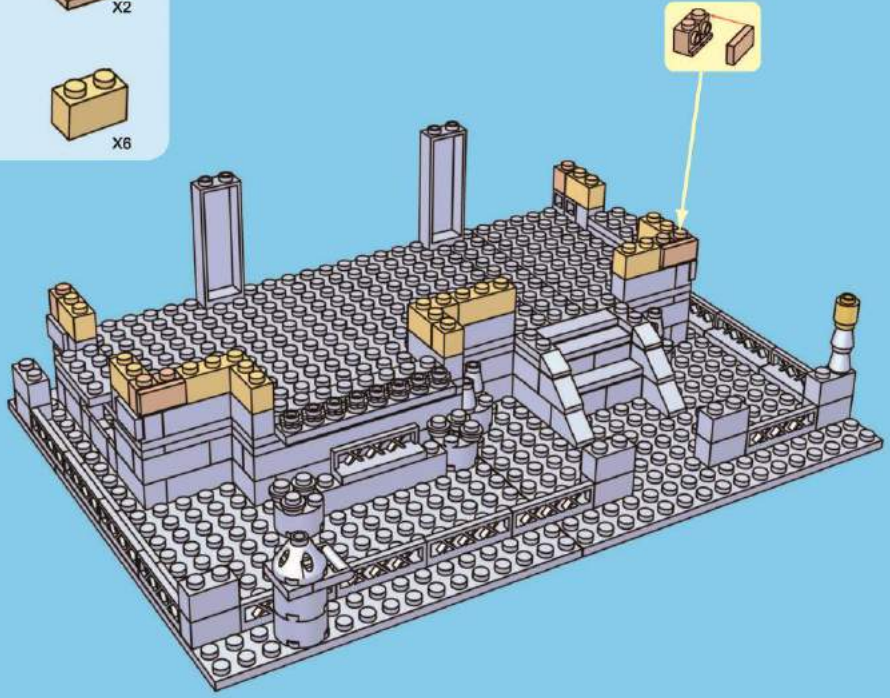

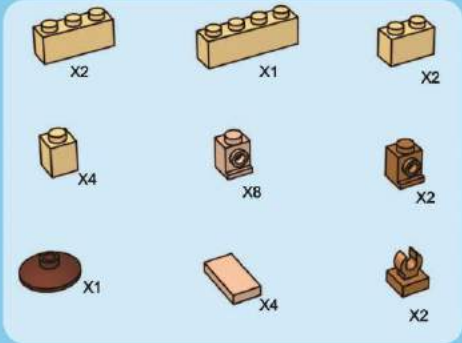

17

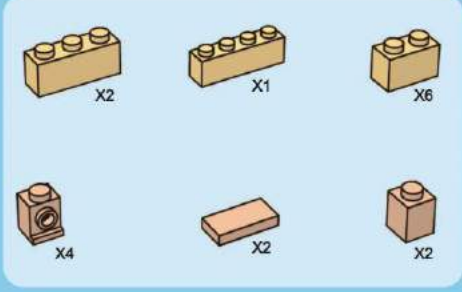
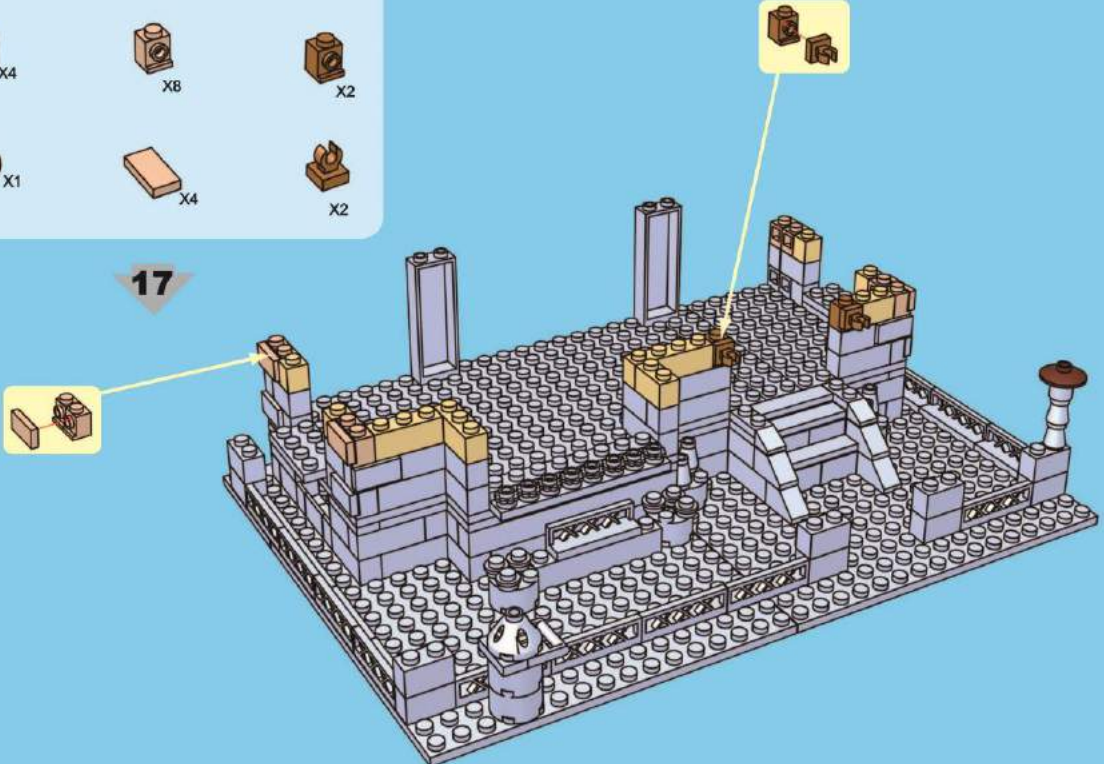

18

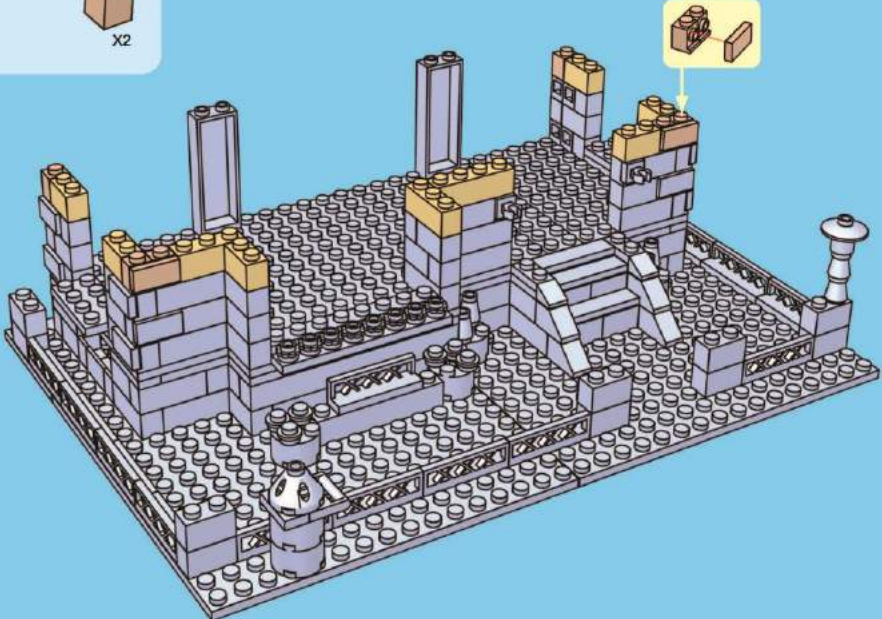

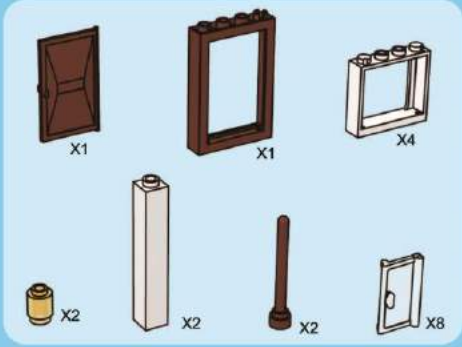

19

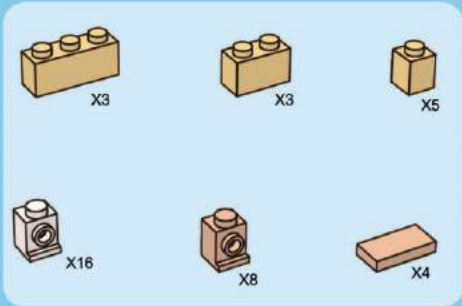
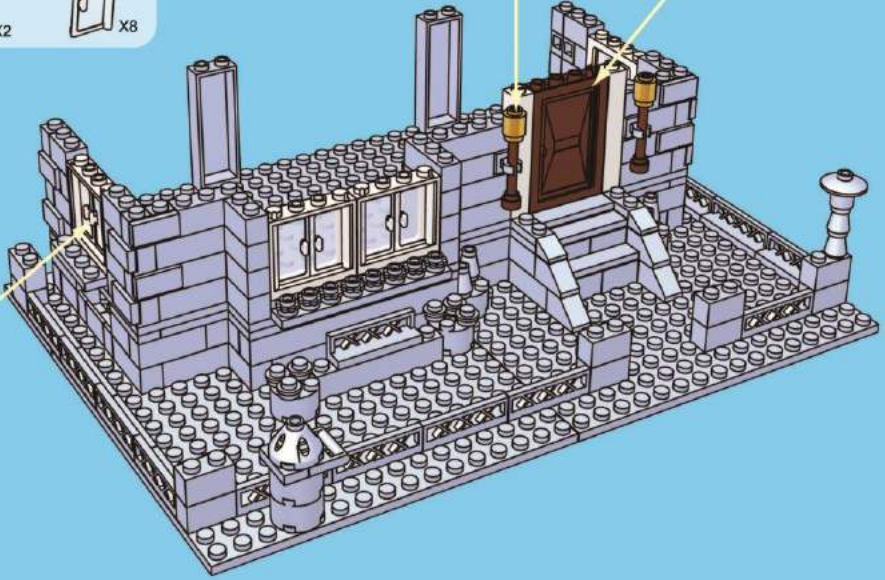
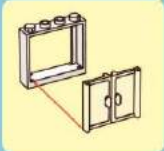

20

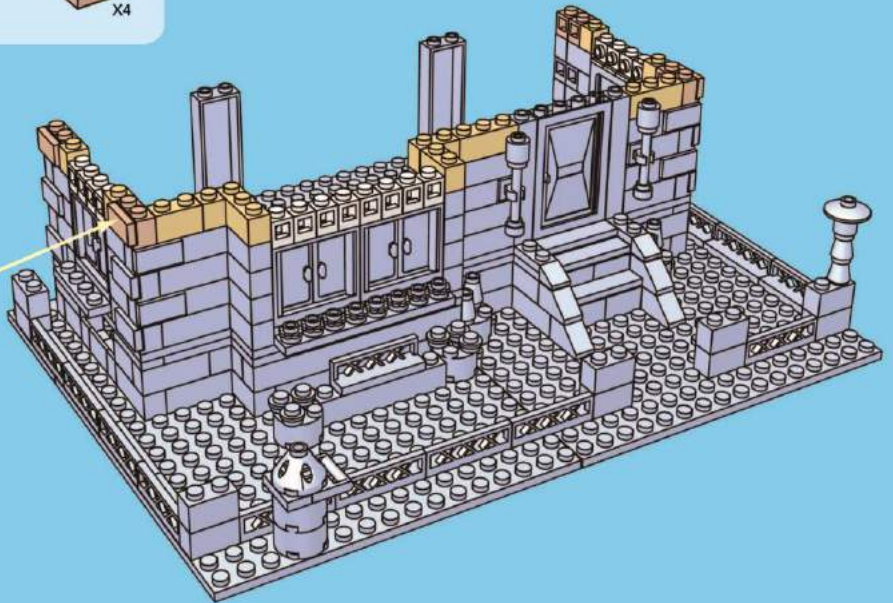

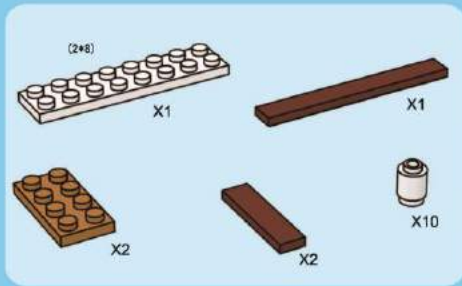

21

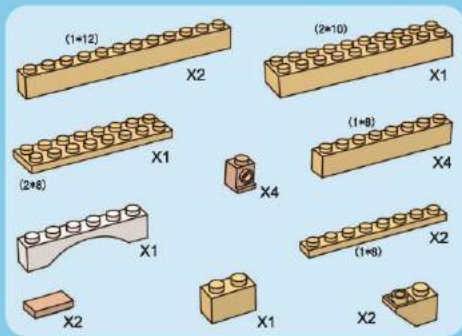
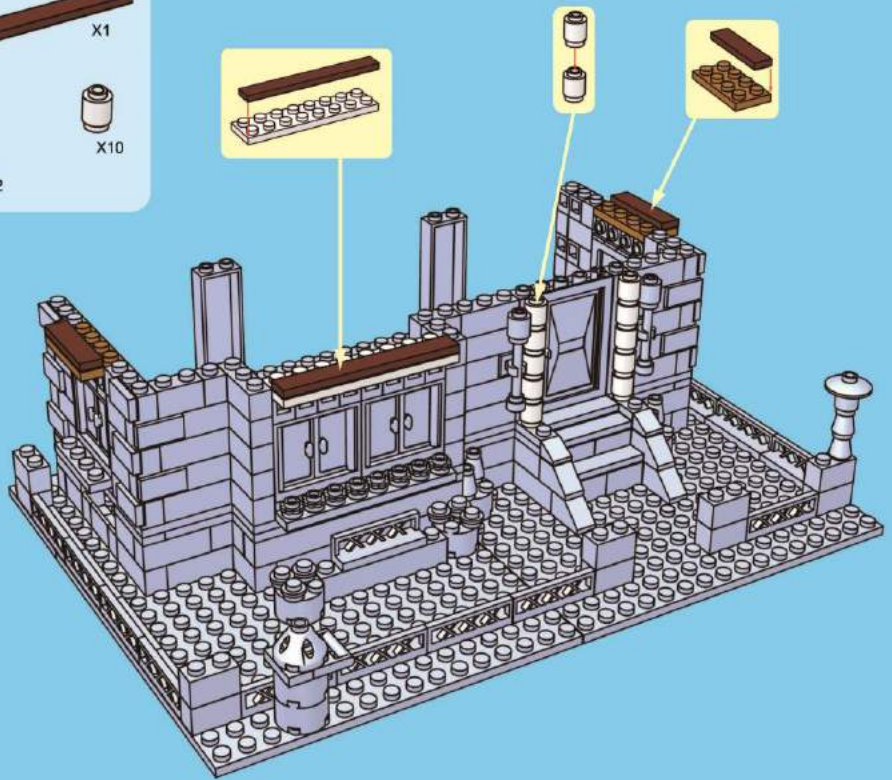

22

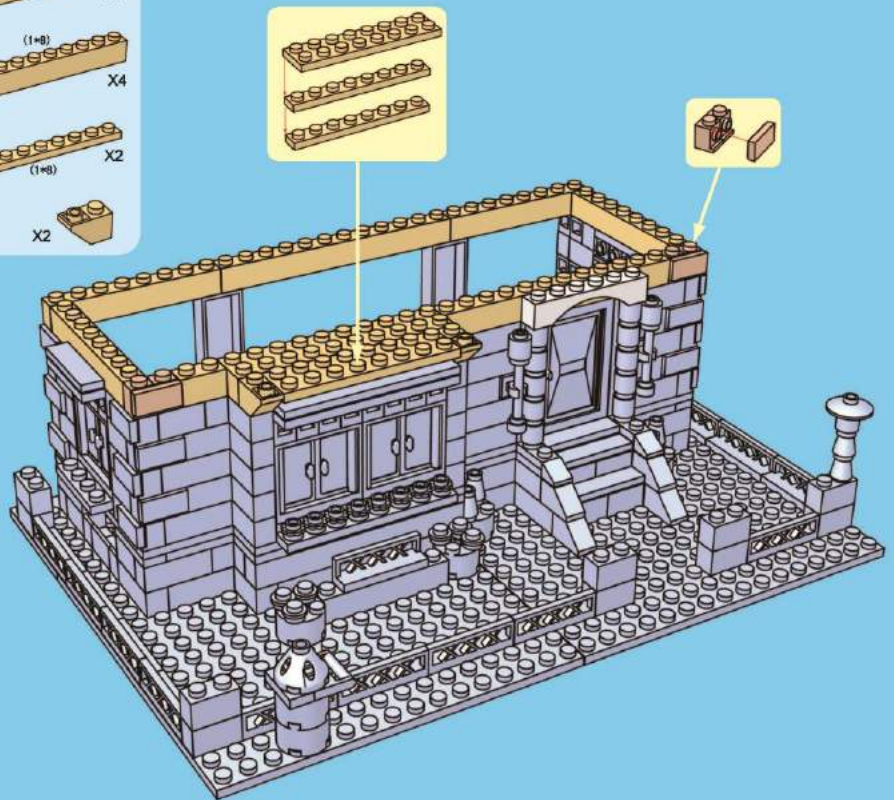

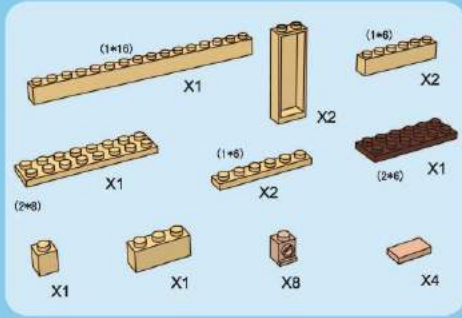

23

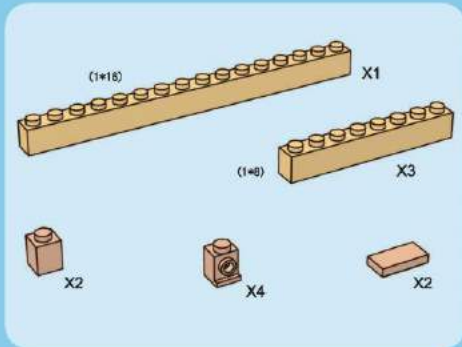
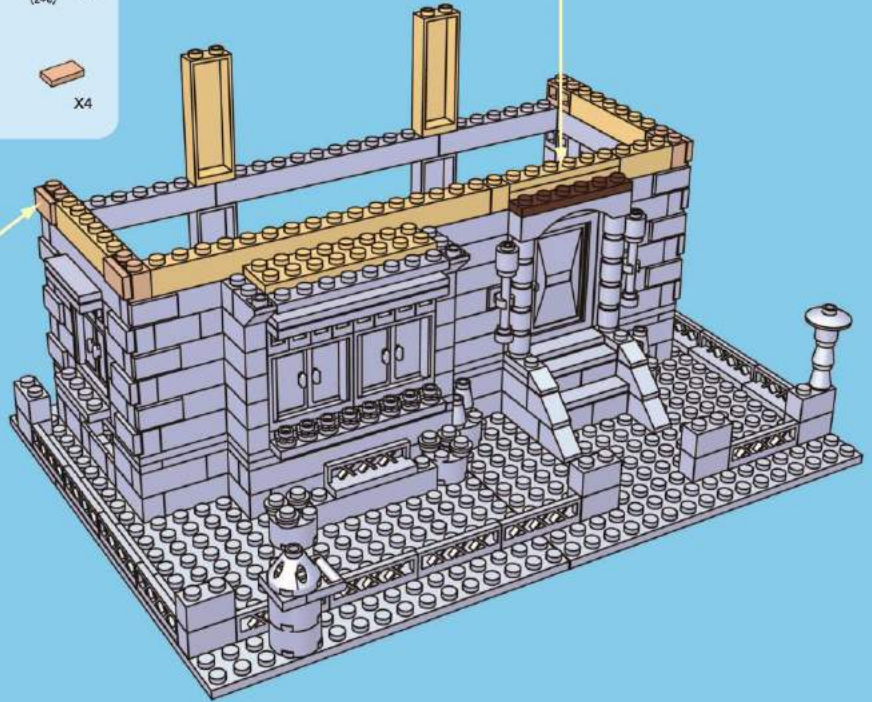
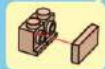

24

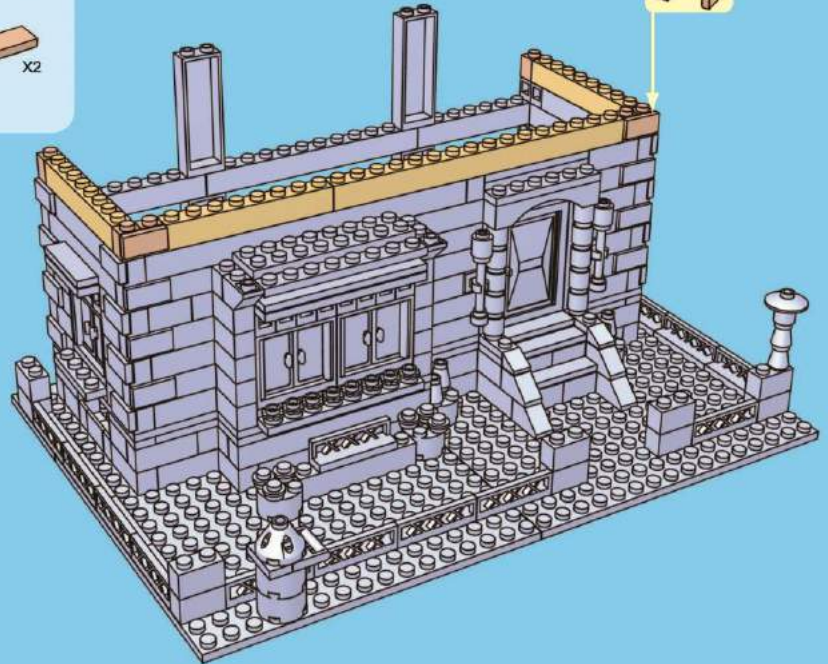

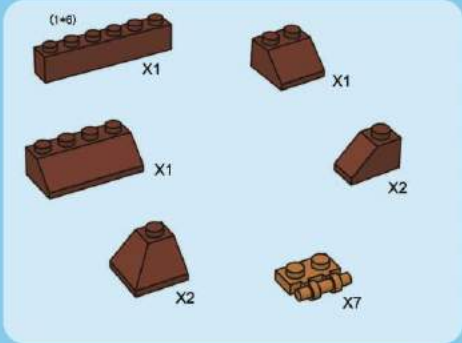

25

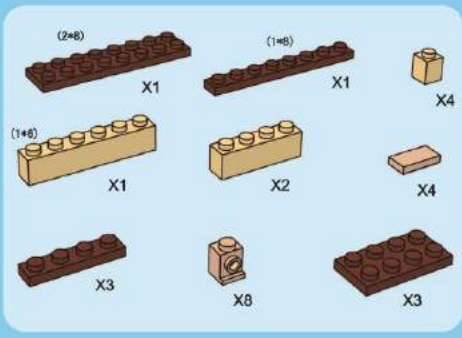
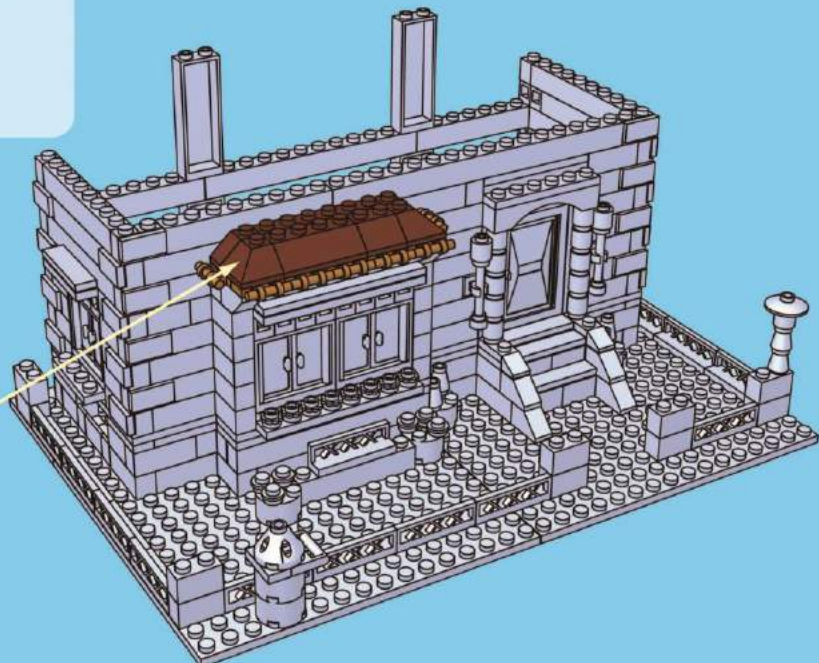

26

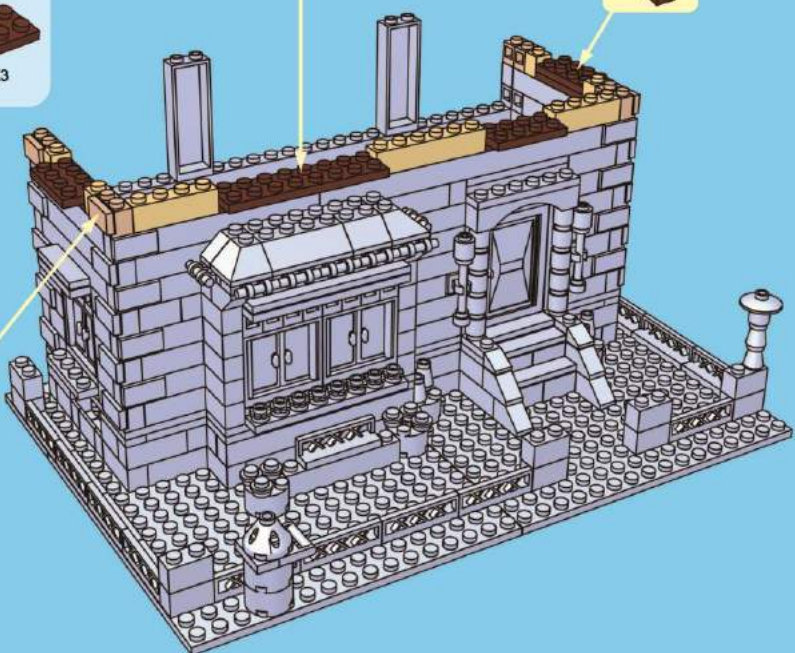

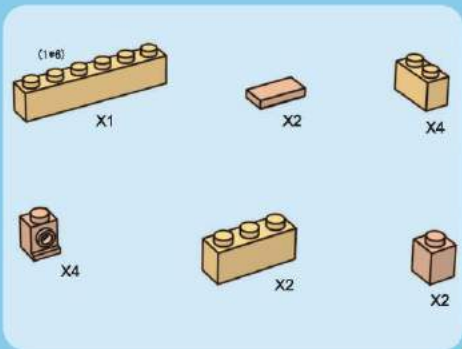

27

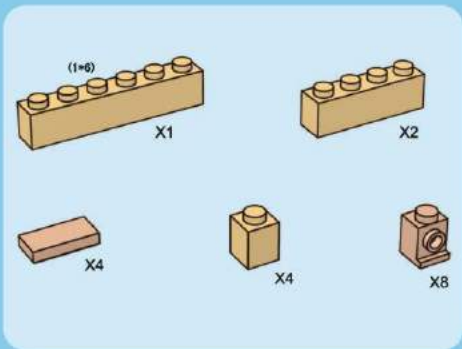

28

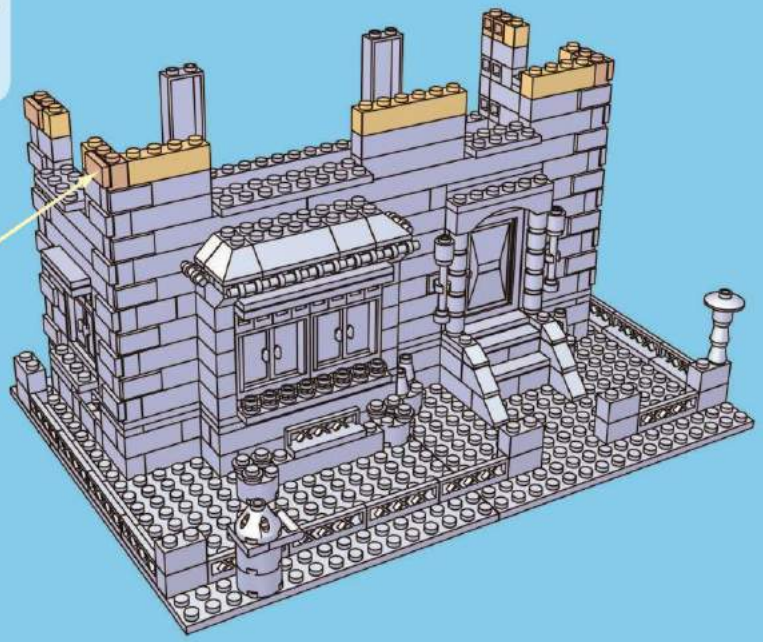

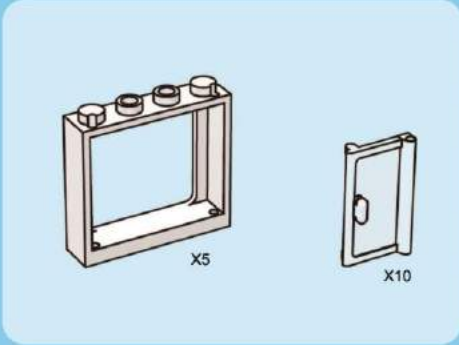

29

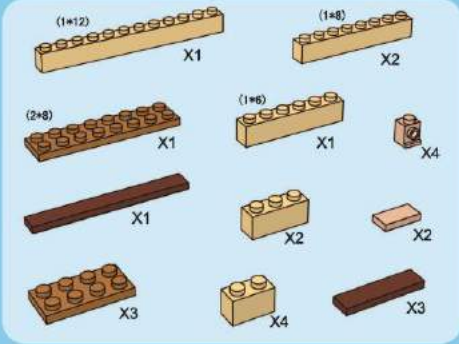
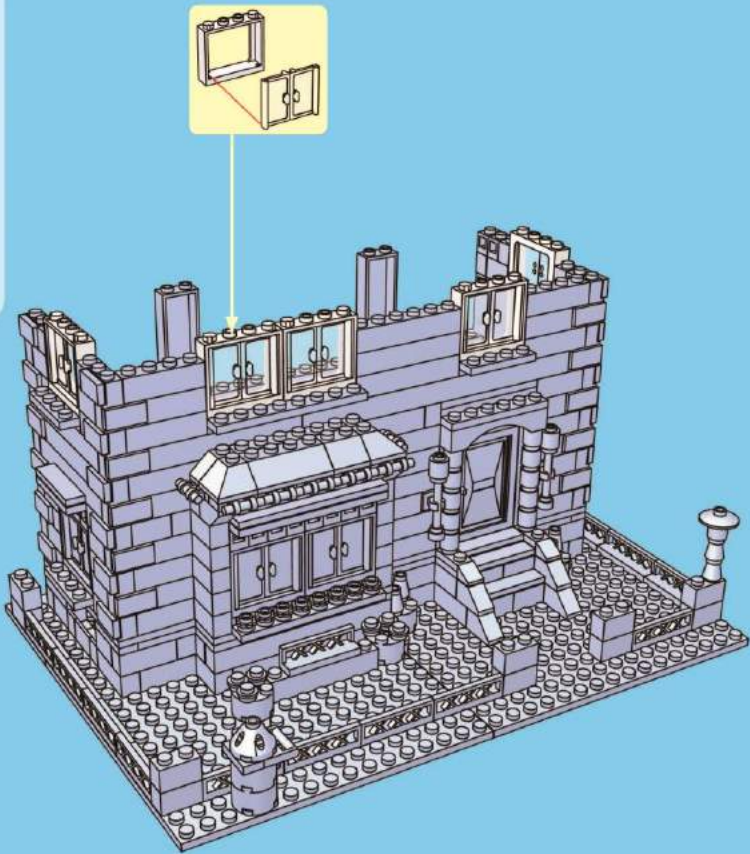

30

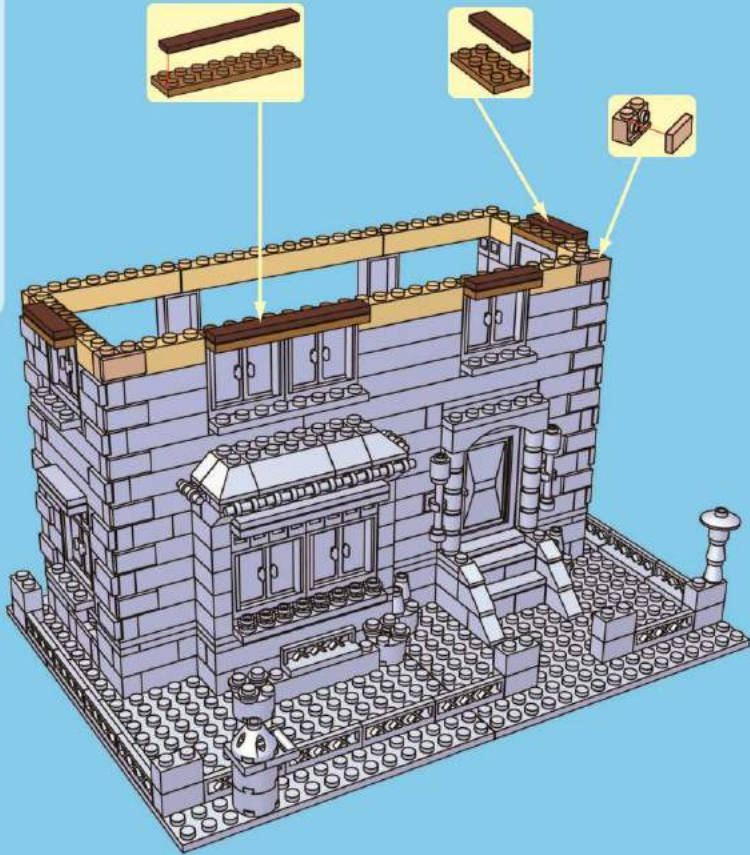

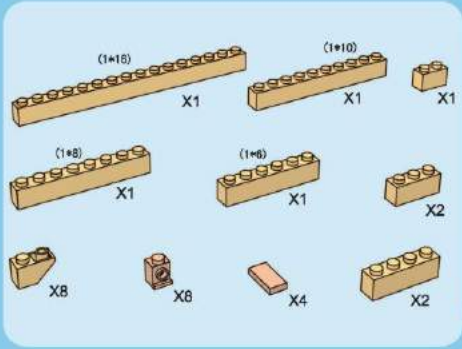

31

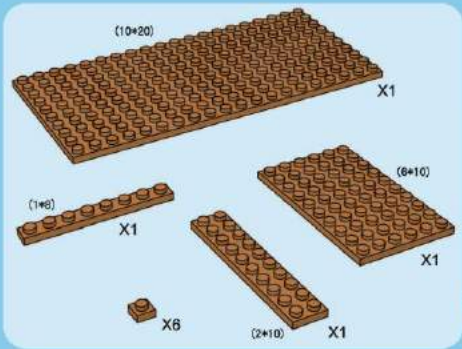
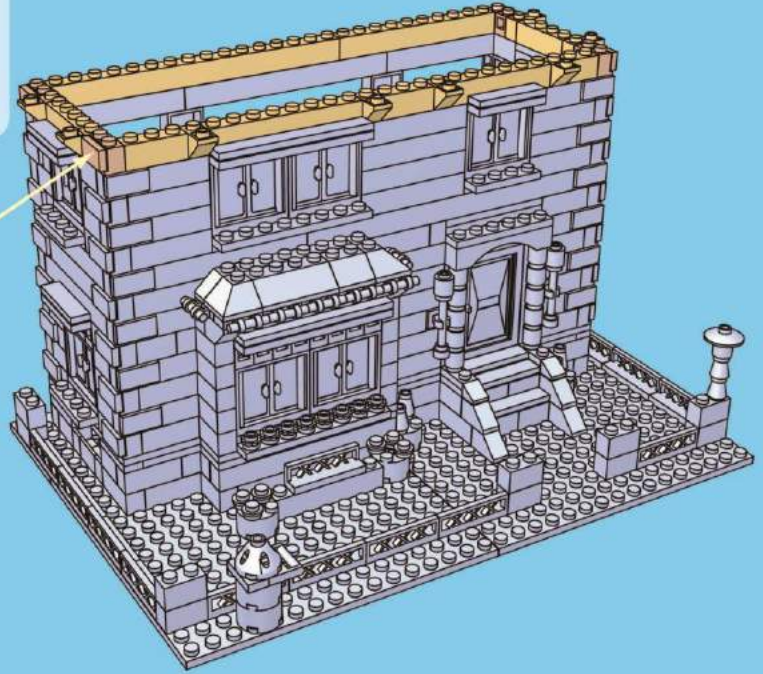

32

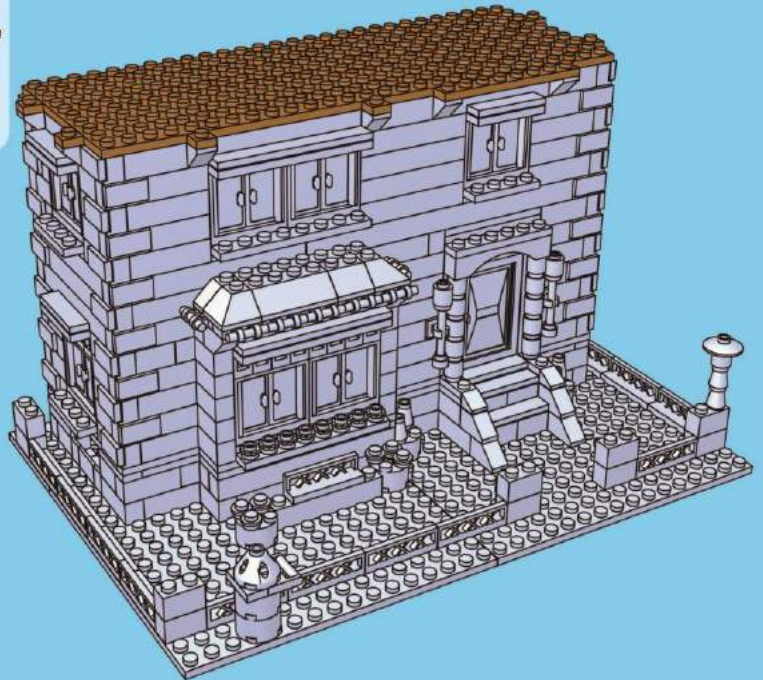

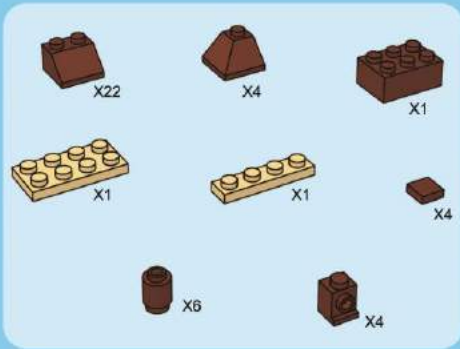

37

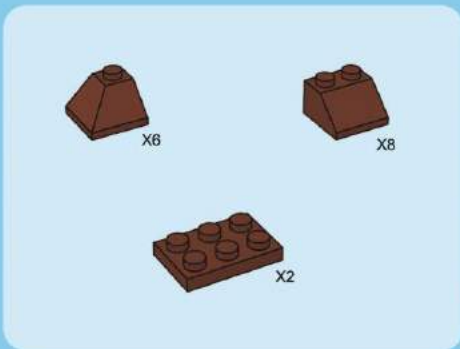
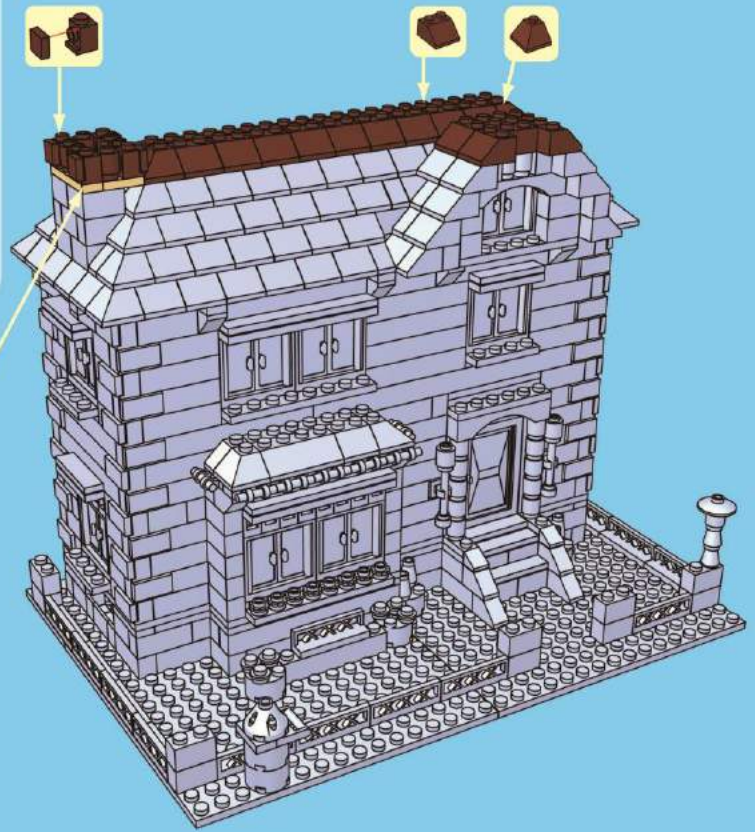
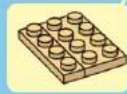

38

