

# INSTALLATION INSTRUCTION ODEON LIGHT

## ART.3321/1,3322/1,3323/1

①

**OFF**

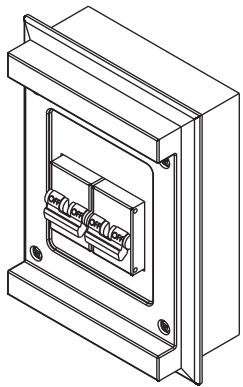

②

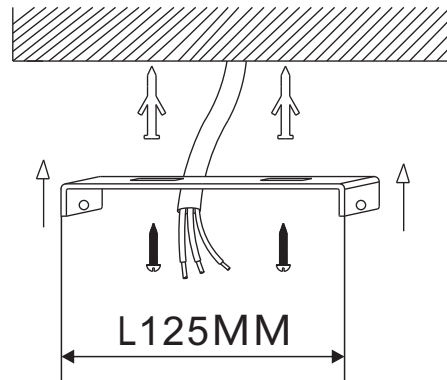

③

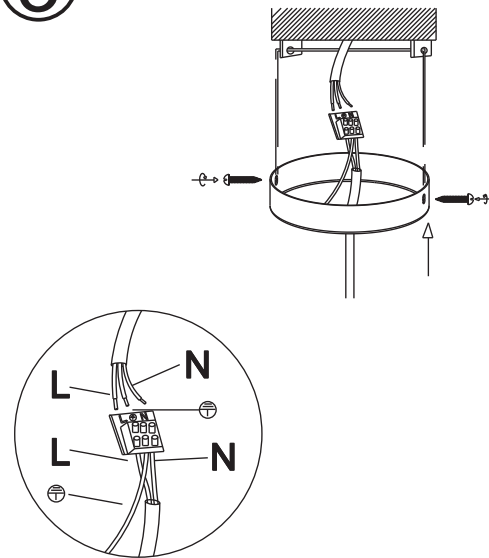

④

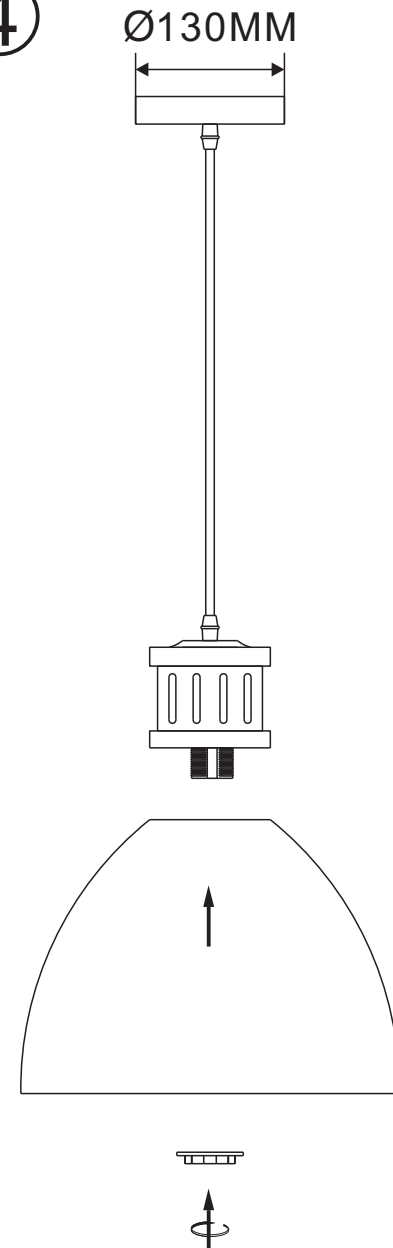

⑤

**ON**

