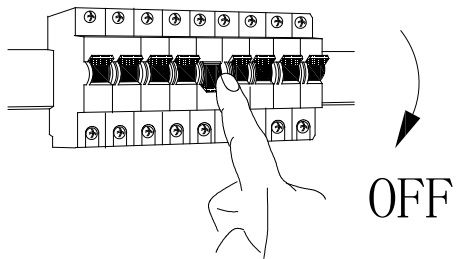
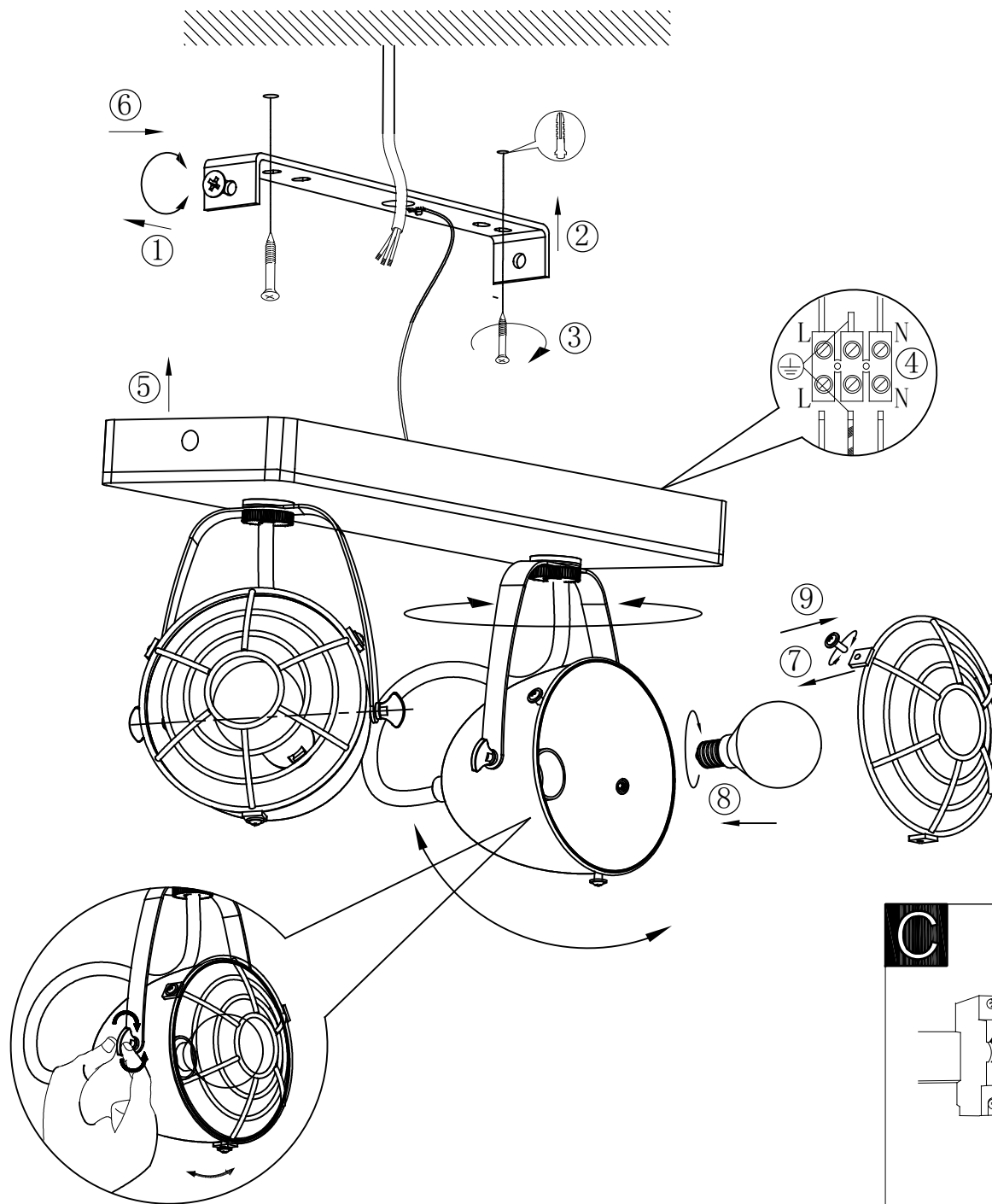
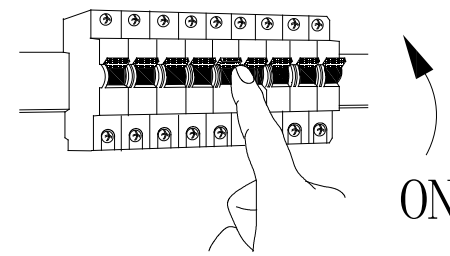

A**B****C**

B49077
www.eglo.com