

Кухонный набор POINT 150  
(Kitchen POINT 150)

Код ТН ВЭД ЕАЭС

9403 40 100 0

9403 90 300 0



отрезать  
и приклеить

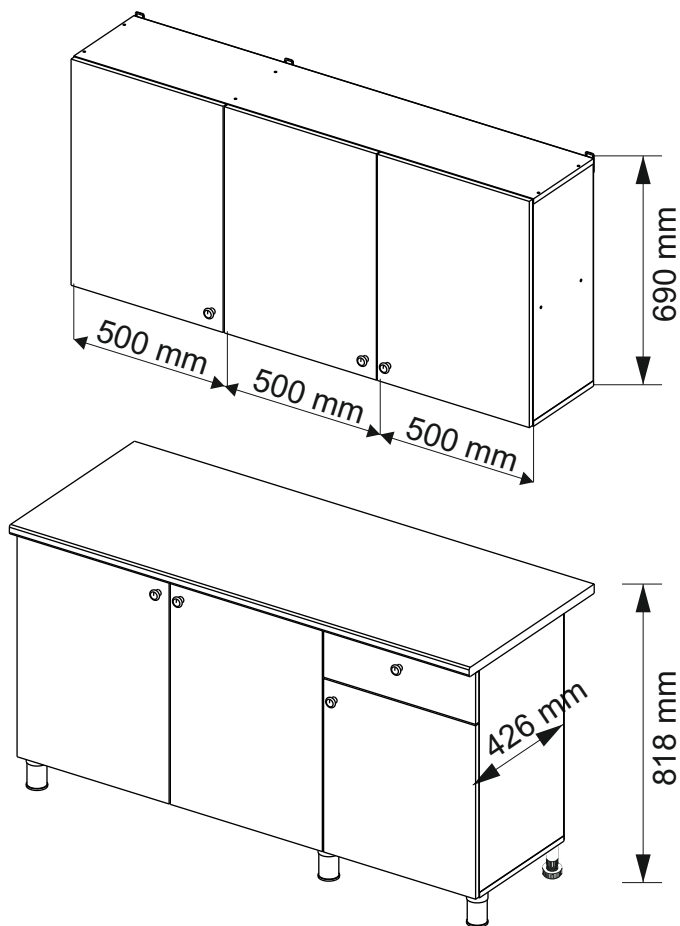

1500	690/ 818	306/ 600

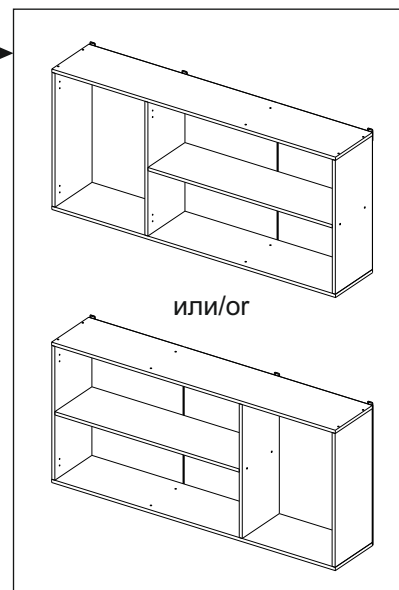

White - Белый

Комплектовочная ведомость / Set package sheet

Упак/ Package	Наименование	Description	Цвет детали/ Décor	Размер / Size, mm	Кол-во/ Quantity	№
1	Фурнитура	Furniture/Cabinetry hardware	-	-	-	-
2	Столешница	Worktop	Antares	1500x600	1	12
	Крышка	Top	White	1500x405	1	8
	Деталь ящика	Side drawers	White	100x400	2	10
	Деталь ящика	Side drawers	White	100x418	1	11
	Бок правый/ср	Side right/middle	White	658x286	2	5
	Вязка	Connecting element	White	982x286	1	7
	Вязка	Connecting element	White	975x405	1	6
	Крышка	Top	White	1500x286	2	9
3	Бок правый	Side right	White	674x405	1	3
	Бок левый	Side left	White	658x286	1	4
	Соед элемент	Connecting back element	-	656 mm	2	16
	Бок левый	Side left	White	674x405	1	1
	Бок средний	Side middle	White	674x405	1	2
4	Панель	Drawer panel	см упак/look at the package	156x496	1	13
	Створка	Door		526x496	1	14
	Створка	Door		686x496	5	15
	ХДФ	Back element	White	686x502	2	17
	ХДФ	Back element	White	686x490	1	18
	ХДФ	Back element	White	686x496	3	19
	ХДФ	Back element	White	450x407	1	20

(PL) Instrukcja montażu

(CZ) Návod k montáži

(D) Montageanleitung

(GB) Assembly instruction

(F) Model d'emploi

(HU) Szerelési útmutató

(I) Istruzione di montaggio

(NL) Handleiding voor de montage



(RU) Инструкция по монтажу

(RO) Instrucțiuni de montare

(SK) Návod k montáži

(TR) Montaj talimatı

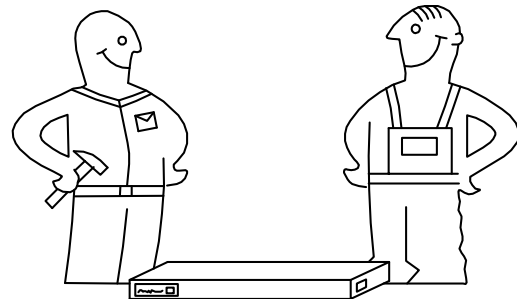
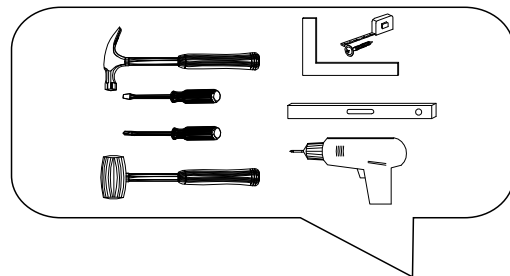



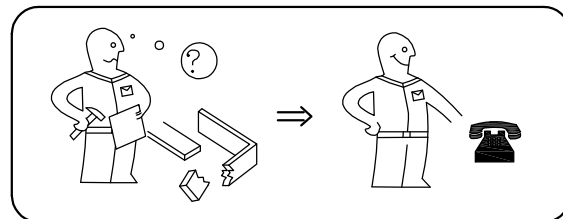
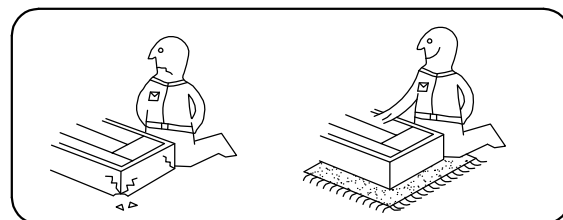



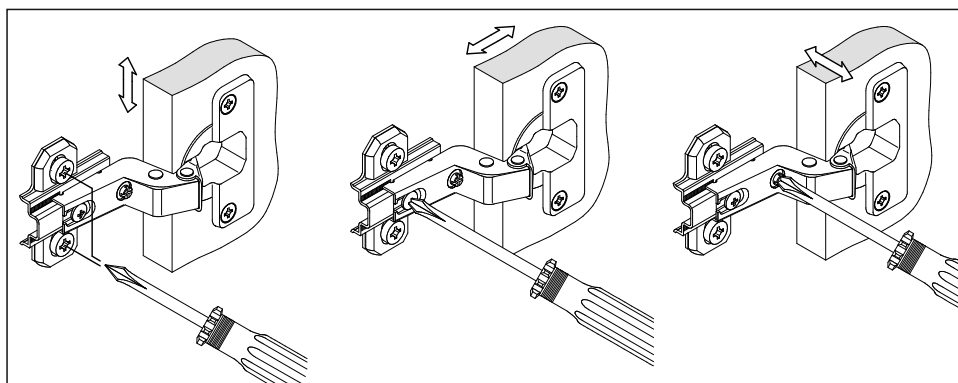
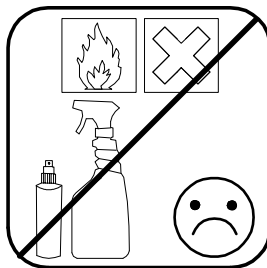
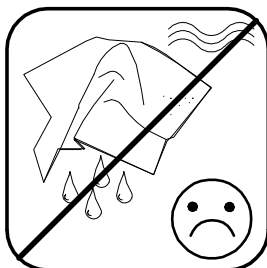
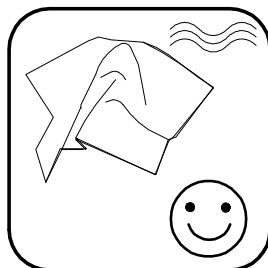
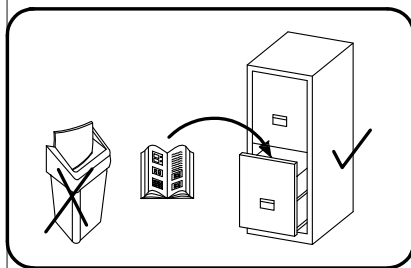

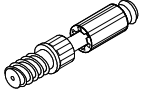

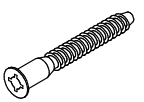



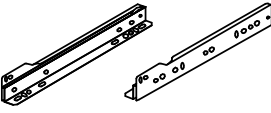
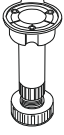
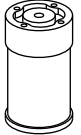

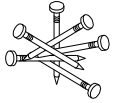

⚠ <b>Uwaga • Upozornění • Achtung • Attention • Caution • Figyelem</b> <span style="float: right;">⚠</span> <b>Attenzione • Opgelet • Внимание • Atenție • Upozornenie • Dikkat</b>	
PL	Czyszczenie należy wykonać wyłącznie za pomocą ściereczki lub lekko nawilżonego ręcznika. Nie stosować środków czyszczących do szorowania.
CZ	Čistění je nutné vykonávat výhradně pomocí utěrky nebo lehce navlhčeného ručníku. Nepoužívejte čisticí prostředky obsahující abrazivní částice.
D	Bitte nur mit einem Staubtuch oder leicht feuchtem Lappen reinigen. Keine scheuernden Putzmittel verwenden.
GB	Please only clean with a duster or a damp cloth. Do not use any abrasive cleaners.
F	Le nettoyage se fait uniquement à l'aide d'un torchon ou d'une serviette légèrement mouillée.
HU	A tisztítás kizárólag törülköruha vagy enyhén nedvesített törölköző segítségével végezhető. Súroló hatású tisztítószereket nem szabad használni.
I	Pulire esclusivamente con un panno o un asciugamano umido.
NL	Reinig alleen met een stofdoek of een lichtjes vochtige doek. Gebruik geen schurende poetsmiddelen.
RU	Очищайте от пыли тряпкой или слегка влажной ветошью. Не допускается применение чистящих средств, не предназначенных для ухода за мебелью.
RO	Curățarea trebuie efectuată numai cu o cârpă sau cu un prosop ușor umezit. Nu utilizați agenți de curățare abrazivi.
SK	Čistení je nutné vykonávať výhradne pomocí utierky alebo ľahko zvlhnutým ručníkom. Nepoužívajte čistiace prostriedky obsahujúce abrazívne častice.
TR	Lütfen sadece bir toz bezilye veya hafif nemli yumuşak bir bezle siliniz. Aşındırıcı temizlik malzemeleri kullanmayınız.

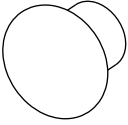

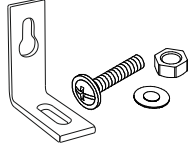
**Karta serwisowa • Servisní list • Service Karte • Service card • Carte de service • Szervizkártya**  
**Scheda di servizio • Service kaart • Сервисная карта • Fisa service • Servisný list • Servis karti**



1		2		5	7x50	6	6,3x10,5	10	3,5x25
									
8 x		8 x		28 x		28 x		12 x	
15		18	3,5x15	24	400 mm	35	100 mm	59	100 mm
									
1 x		60 x		1 x		3 x		3 x	
45		48		53		71	∅ 5 mm	72	
									
8 x		50 x		3 x		2 x		22 x	
91	Hinge A	125	K1	92	Hinge B	28		3	
									
8x		7 x		2 x		2 x		5 x	

73		90	Hinge C
			
8 x		2 x	

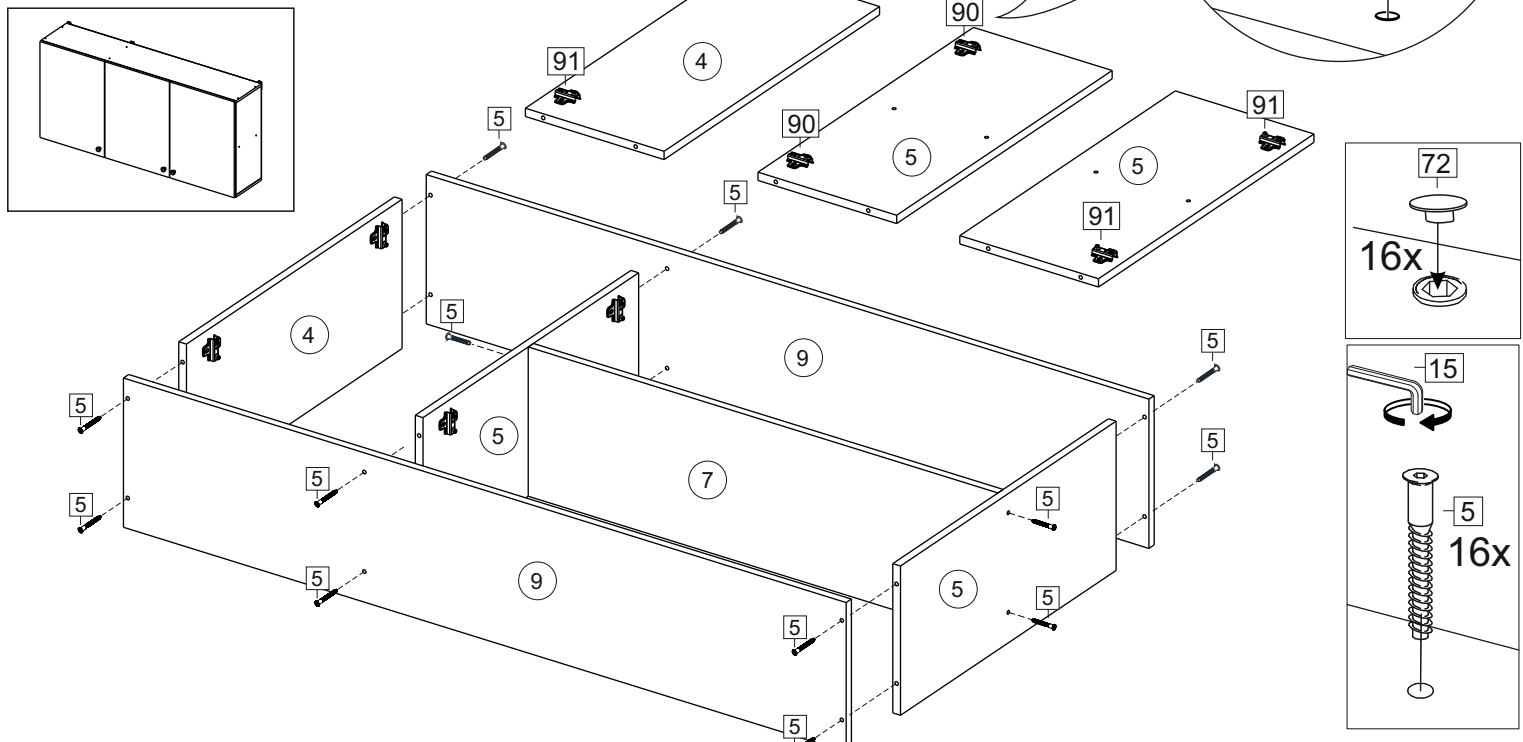

4

