

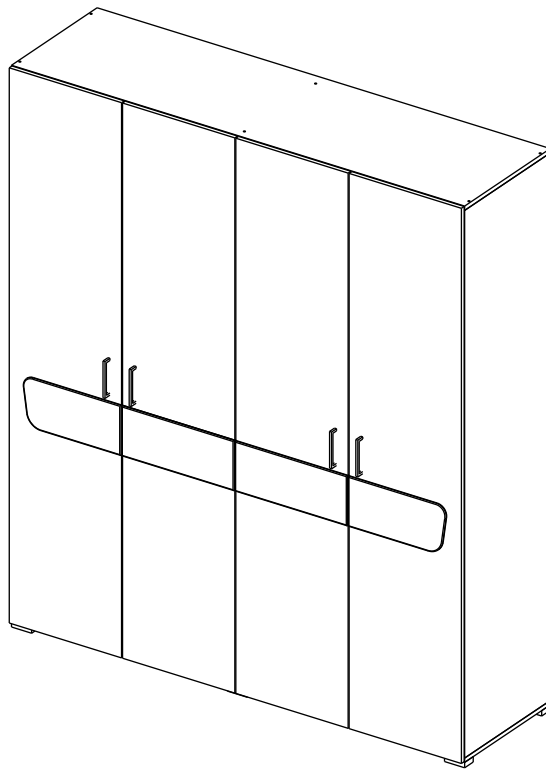

отрезать  
и приклеить



1800	2074	520

32ШМК2511  
32ШМФ2512

Комплектовочная ведомость/Set package sheet

Упак/ Package	Наименование	Description	Цвет детали/ Décor	Размер / Size, mm	Кол-во/ Quantity	№
1	Фурнитура	Furniture/Cabinetry hardware	-	-	-	-
2	Боковина левая	Side left	White	2022x500	1	1
	Боковина средняя	Side middle	White	2022x500	1	2
	Боковина правая	Side right	White	2022x500	1	3
3	Крыша	Top	White	1800x500	2	4
	Вязка	Connecting element	White	875x500	5	5
	Тяга	Connecting element	White	875x100	1	6
	ДВП	Back element	White	390x897	2	7
	ДВП	Back element	White	1660x448	4	8
	Соед элемент	Connecting back element	-	1638 мм	2	16
	Штанга	Wardrobe tube	-	870 мм	1	17

Продается отдельно/Sold separately

1	Створка левая	Door left	White	2050x446	1	9
	Створка левая внутр	Door left internal	White	2050x446	1	10
	Створка правая внутр	Door right internal	White	2050x446	1	11
	Створка правая	Door right	White	2050x446	1	12

White - Белый

Pine grand - Сосна гранд

Вставка МДФ 8 мм	Insert	Pine grand	446x186	2
Вставка МДФ 8 мм левая	Insert left	Pine grand	388x186	1
Вставка МДФ 8 мм правая	Insert right	Pine grand	388x186	1

(PL) Instrukcja montażu

(CZ) Návod k montáži

(D) Montageanleitung

(GB) Assembly instruction

(F) Model d'emploi

(HU) Szerelési útmutató

(I) Istruzione di montaggio

(NL) Handleiding voor de montage



(RU) Инструкция по монтажу

(RO) Instrucțiuni de montare

(SK) Návod k montáži

(TR) Montaj talimatı

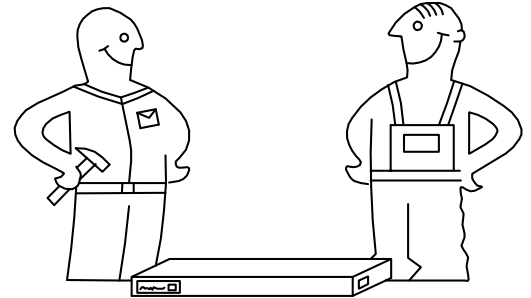
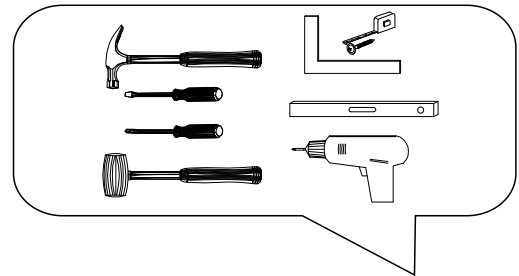



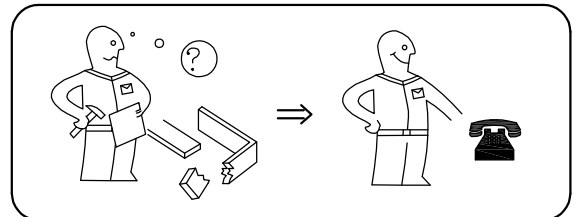
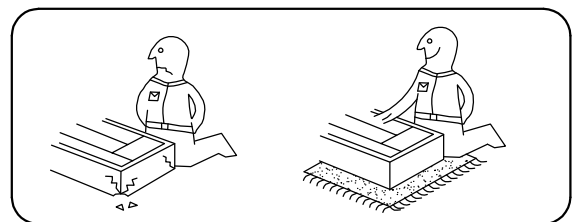



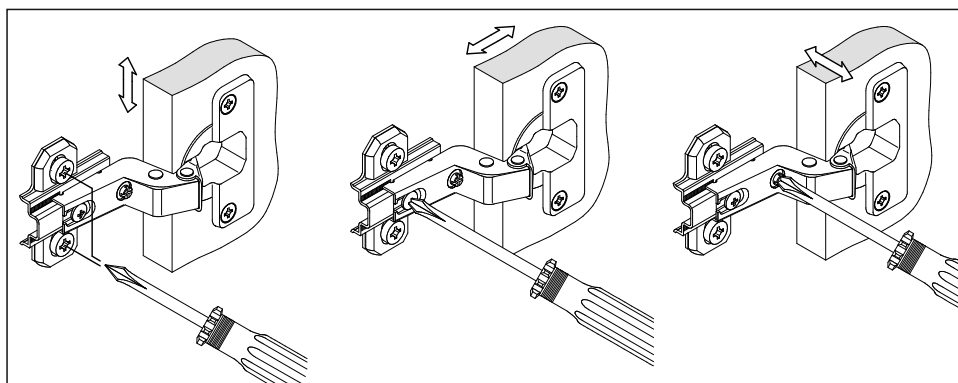
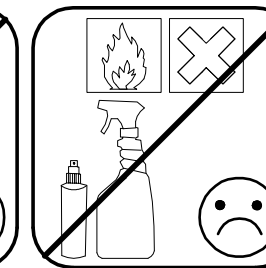
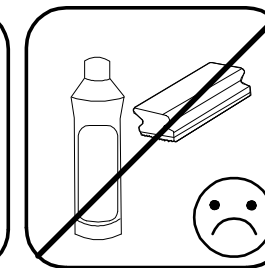
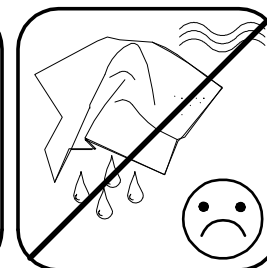
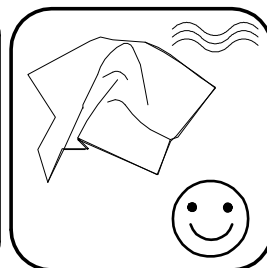
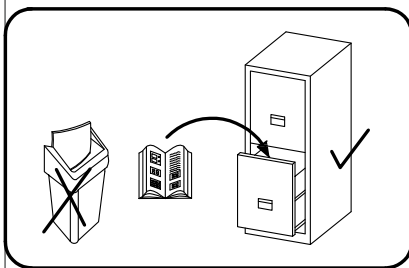

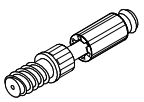

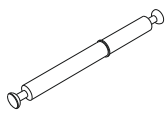
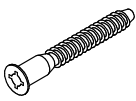
⚠ <b>Uwaga • Upozornění • Achtung • Attention • Caution • Figyelem</b> <span style="float: right;">⚠</span> <b>Attenzione • Opgelet • Внимание • Atenție • Upozornenie • Dikkat</b>	
PL	Czyszczenie należy wykonać wyłącznie za pomocą ściereczki lub lekko nawilżonego ręcznika. Nie stosować środków czyszczących do szorowania.
CZ	Čistění je nutné vykonávat výhradně pomocí utěrky nebo lehce navlhčeného ručníku. Nepoužívejte čisticí prostředky obsahující abrazivní částice.
D	Bitte nur mit einem Staubtuch oder leicht feuchtem Lappen reinigen. Keine scheuernden Putzmittel verwenden.
GB	Please only clean with a duster or a damp cloth. Do not use any abrasive cleaners.
F	Le nettoyage se fait uniquement à l'aide d'un torchon ou d'une serviette légèrement mouillée.
HU	A tisztítás kizárólag törlőruha vagy enyhén nedvesített törölköző segítségével végezhető. Súroló hatású tisztítószereket nem szabad használni.
I	Pulire esclusivamente con un panno o un asciugamano umido.
NL	Reinig alleen met een stofdoek of een lichtjes vochtige doek. Gebruik geen schurende poetsmiddelen.
RU	Очищайте от пыли тряпкой или слегка влажной ветошью. Не допускается применение чистящих средств, не предназначенных для ухода за мебелью.
RO	Curățarea trebuie efectuată numai cu o cârpă sau cu un prosop ușor umezit. Nu utilizați agenți de curățare abrazivi.
SK	Čistení je nutné vykonávať výhradne pomocí utierky alebo ľahko zvlhnutým ručníkom. Nepoužívajte čistiace prostriedky obsahujúce abrazívne častice.
TR	Lütfen sadece bir toz bezilye veya hafif nemli yumuşak bir bezle siliniz. Aşındırıcı temizlik malzemeleri kullanmayınız.

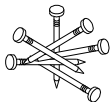
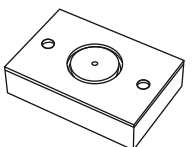

**Karta serwisowa • Servisní list • Service Karte • Service card • Carte de service • Szervizkártya**  
**Scheda di servizio • Service kaart • Сервисная карта • Fisa service • Servisný list • Servis karti**

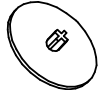
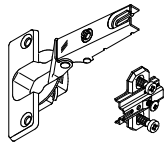
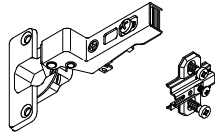
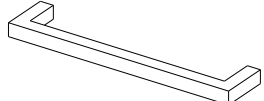

1		2		4		5	7x50	6	6,3x10,5
									
16 x		20 x		2 x		14 x		32 x	
18	3,5x15	15		45		48	2x20	62	80x50x20 mm
									
48 x		1 x		16 x		100 x		6 x	
72	Белый/White	73	Белый/White	91	Hinge A	92	Hinge B	126	C42 128 mm
									
8 x		20 x		8 x		8 x		4 x	
49		71	Белый/White						
									
2 x		8 x							
		Ø 5 mm							

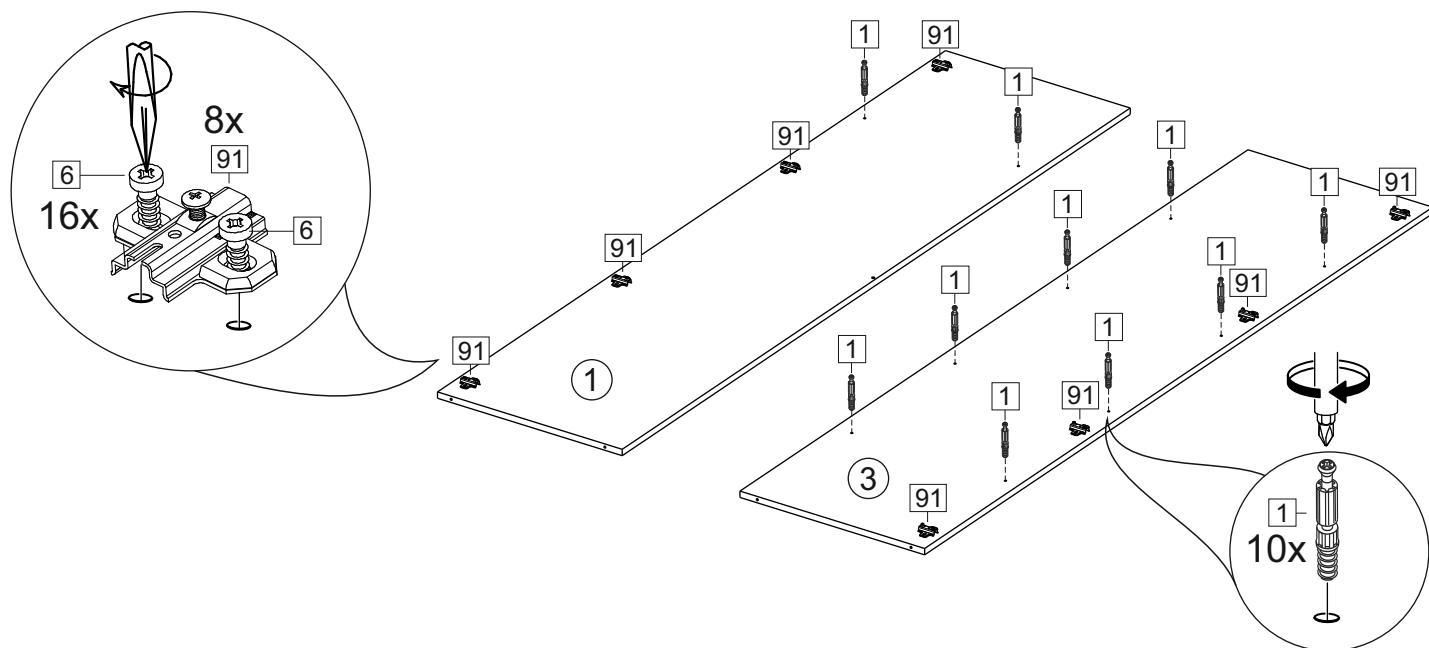

4

