

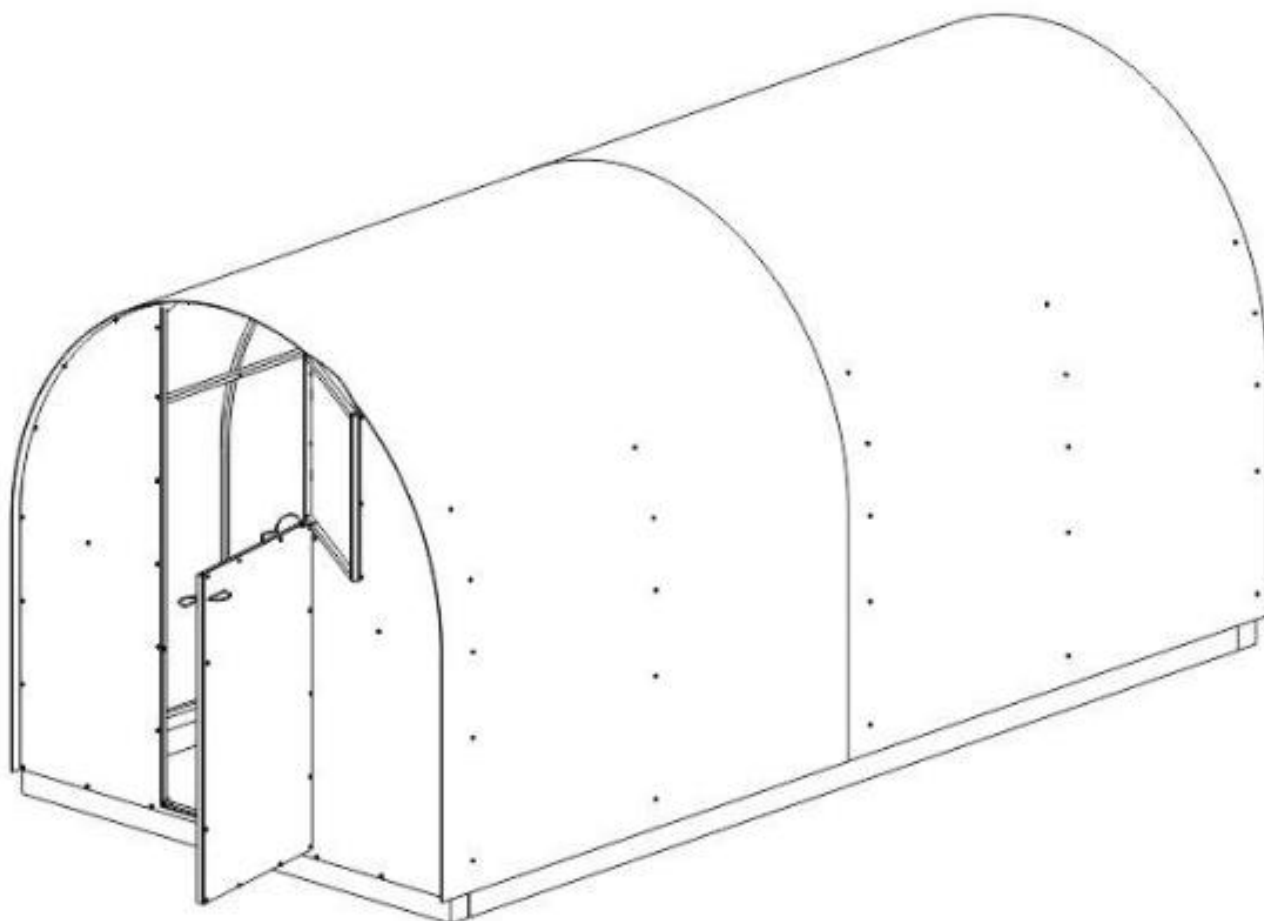











Инструкция по сборке теплицы «Оптима III-Цинк»





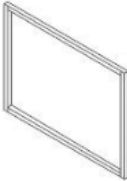

Комплектация

Элементы каркаса

Деталь	Количество	Деталь	Количество
	1 шт.		1 шт.
	2 шт.		4 шт.
	3 шт.		7 шт.
	10 шт.		1 шт.
	1 шт.		1 шт.
	1 шт.		

Крепежи

	количество	размер
	25 шт.	M6 × 50 мм
	25 шт.	M6
	25 шт.	6
	10 шт.	5,5 × 19 мм
	16 шт.	3,9 × 16 мм

Эти крепежи в комплект не входят



5 × 60 мм, 14 шт



5,5 × 25 мм, 150 шт.

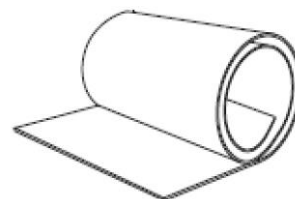

Сотовый поликарбонат 2,1 × 6 м, 3 листа

Рекомендации по сборке

Для сборки вам потребуется следующий инструмент:

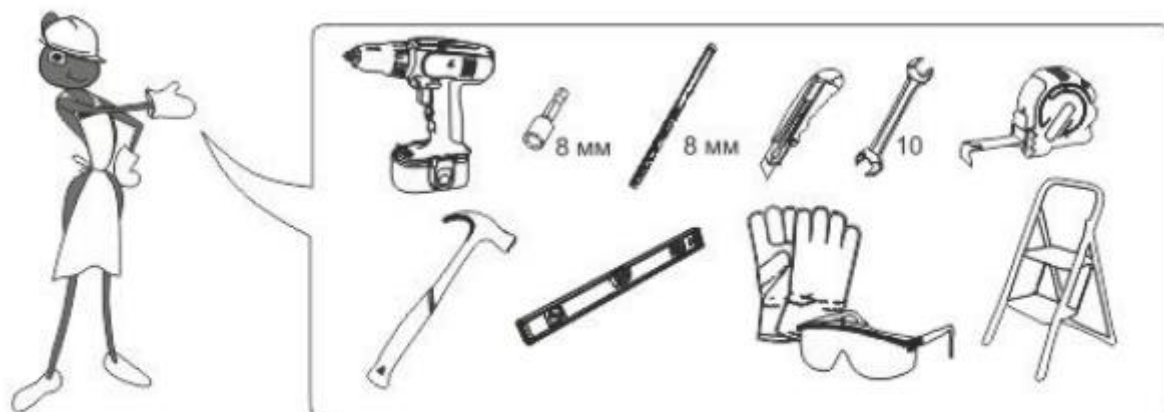

ВАЖНО! Рекомендуем собирать теплицу вдвоём.

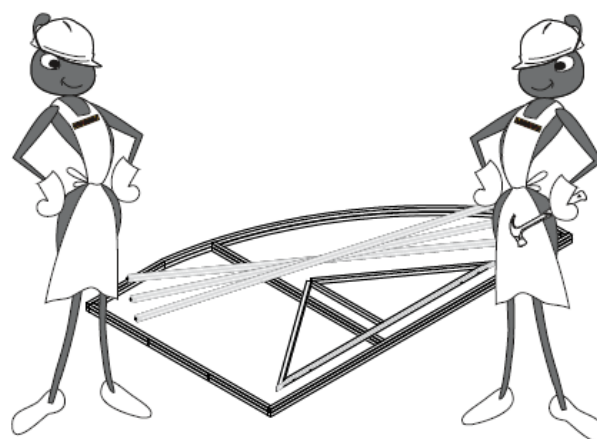
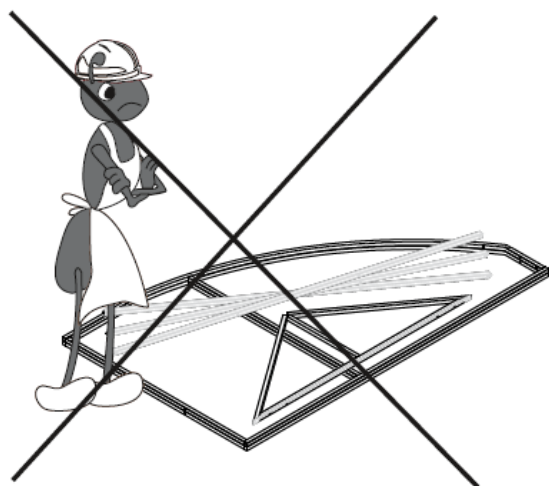

Этапы сборки

Перед началом сборки обязательно ознакомьтесь с инструкцией.

