

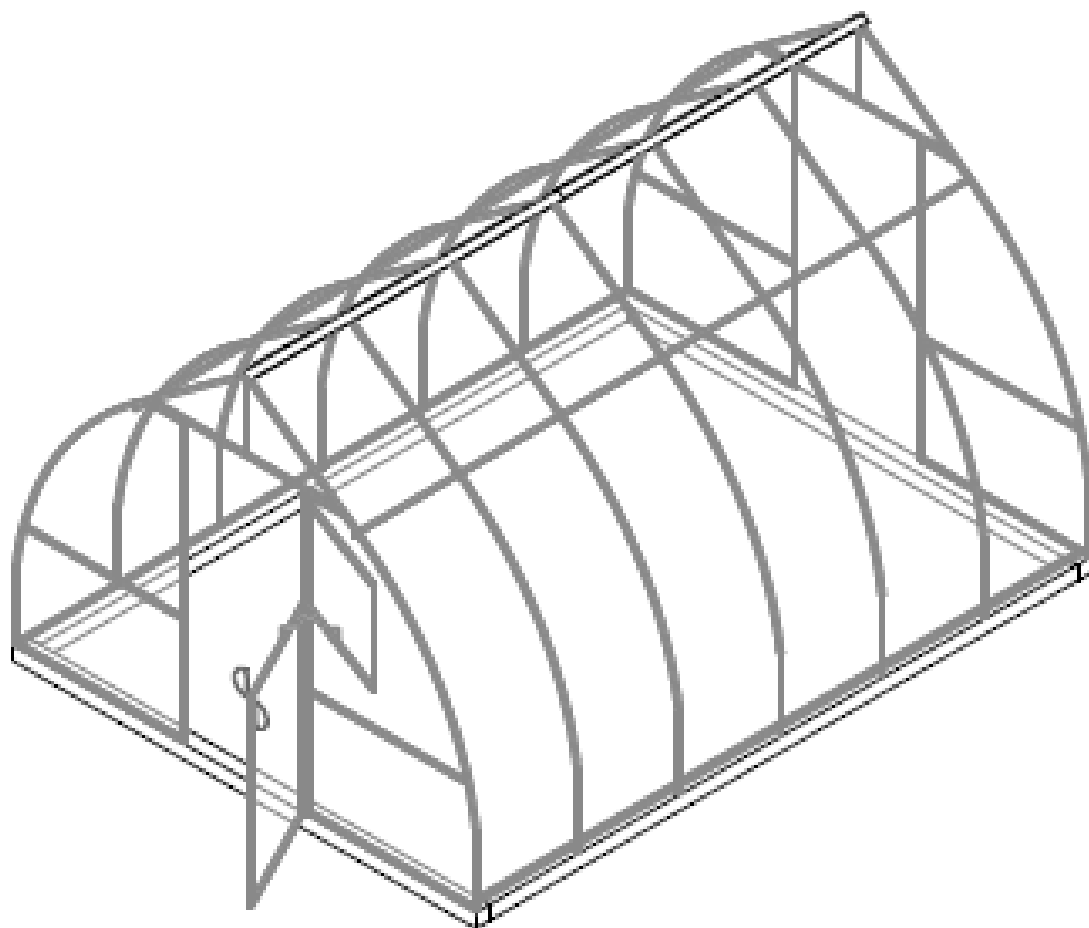

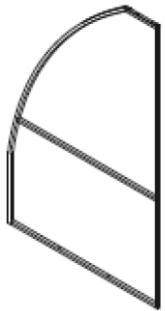







Инструкция по сборке теплицы «Капелюха»

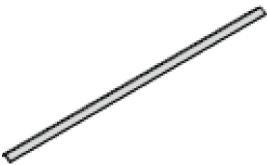





Комплектация

Элементы каркаса

Деталь	Количество	Деталь	Количество
	4 шт.		1 шт.
	2 шт.		7 шт.
	2 шт.		4 шт.
	10 шт.		12 шт.
	10 шт.		1 шт.
	1 шт.		

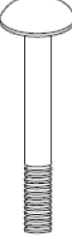
Крепежи

	количество	размер
	20 шт.	4,2 × 16 мм
	44 шт.	3,9 × 16 мм.
	15 шт.	5,5 × 19 мм
	36 шт.	M6 × 50 мм.
	36 шт.	6 мм.
	36 шт.	M6

Эти крепежи в комплект не входят



5 × 60 мм, 18 шт.



5,5 × 25 мм, 220 шт.

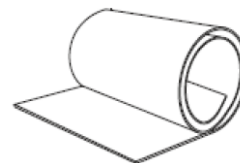

3 шт.

Рекомендации по сборке

Для сборки вам потребуется следующий инструмент:

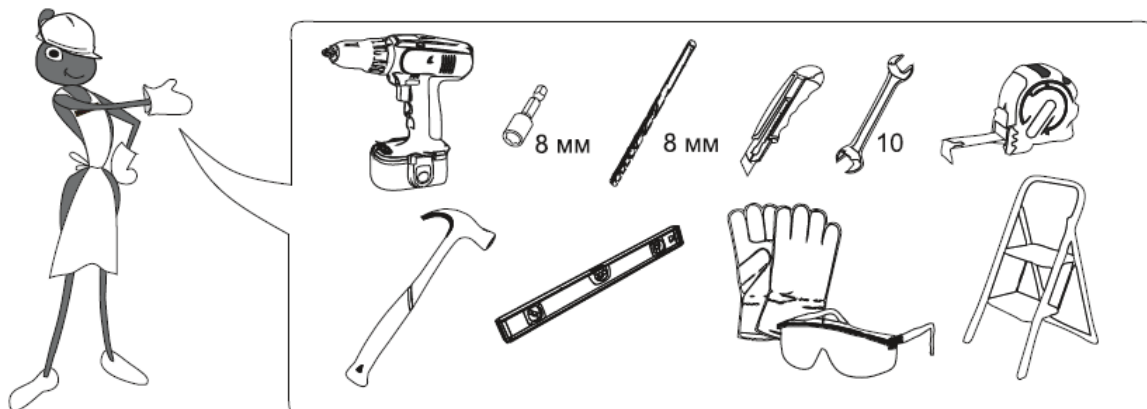

ВАЖНО! Рекомендуем собирать теплицу вдвоём.

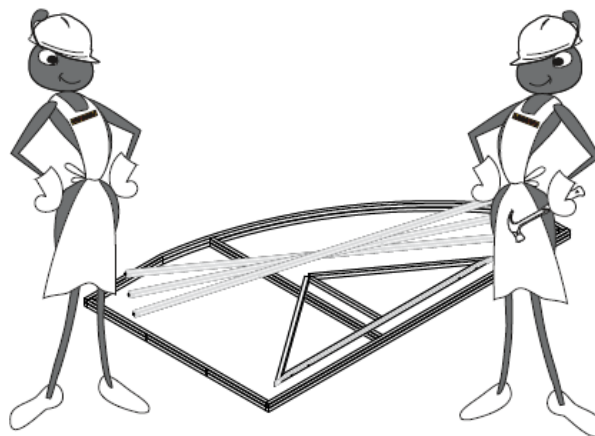
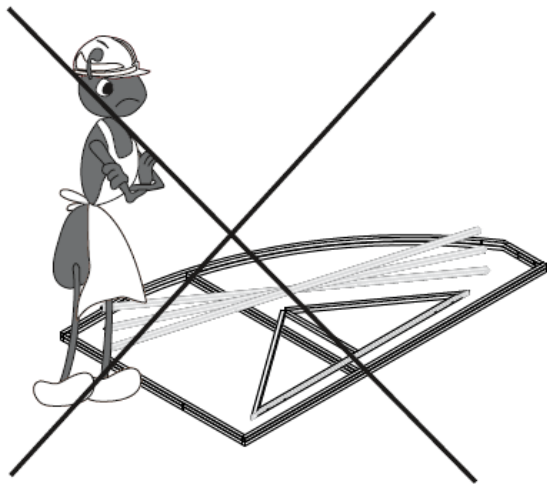

Этапы сборки

Перед началом сборки обязательно ознакомьтесь с инструкцией.

