

ST LUCE

Installing Instructions

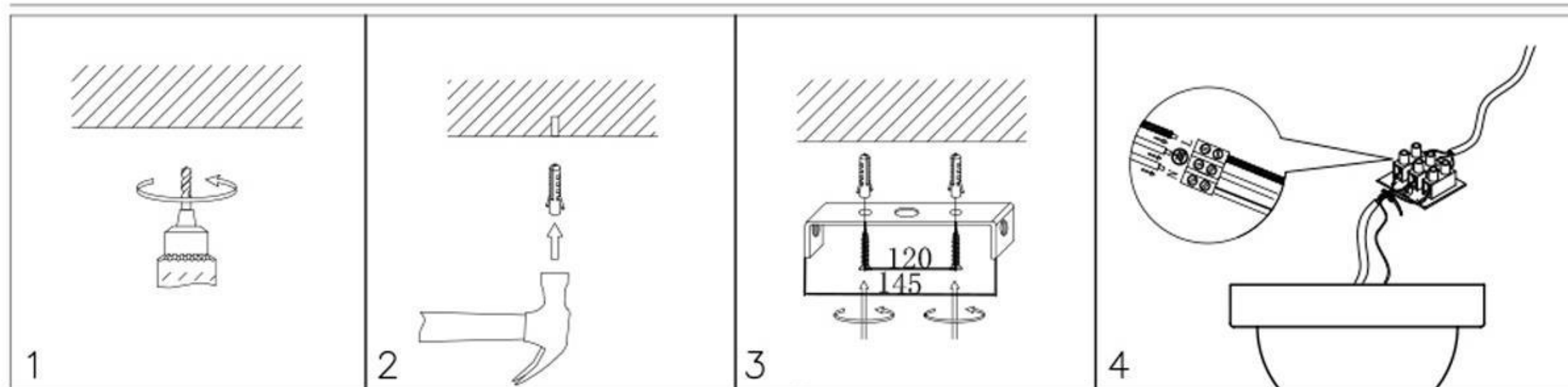

Model:SL438.202.20

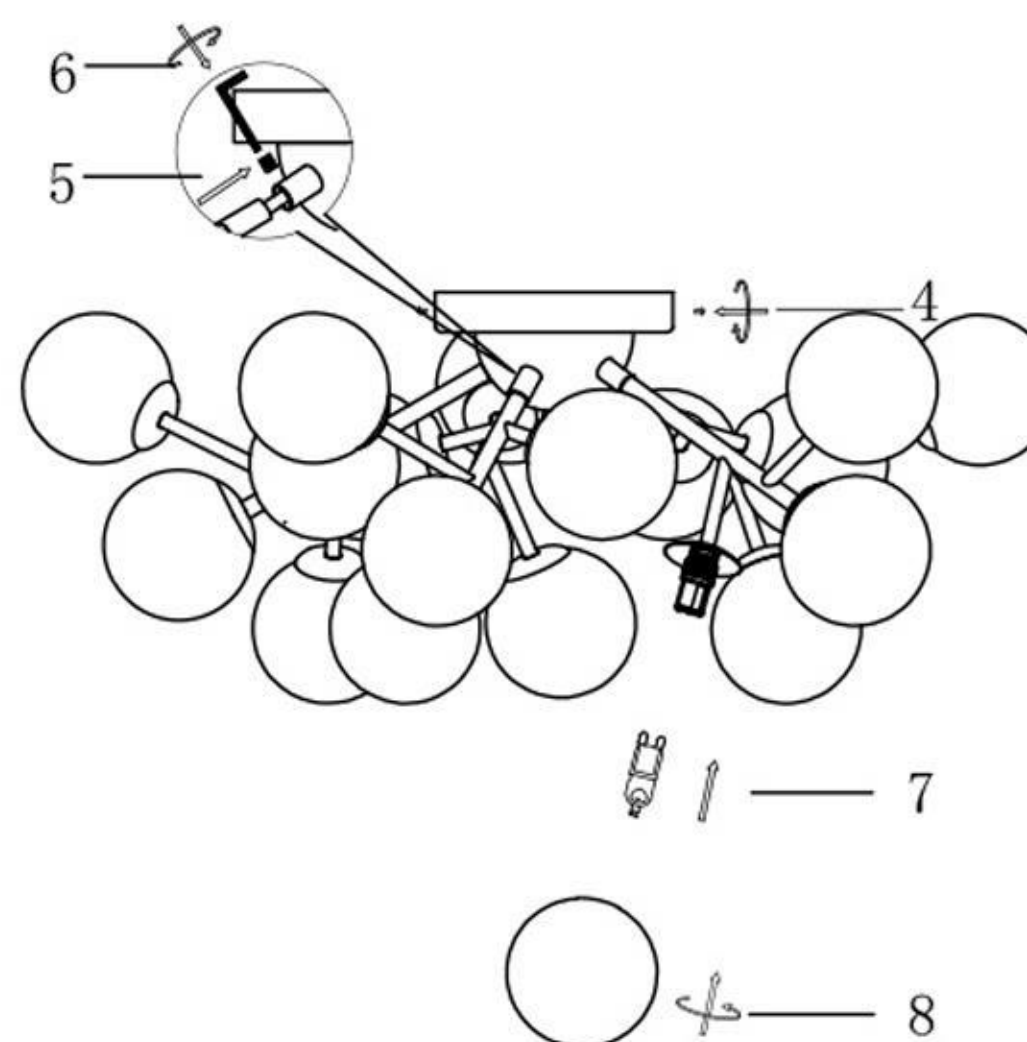
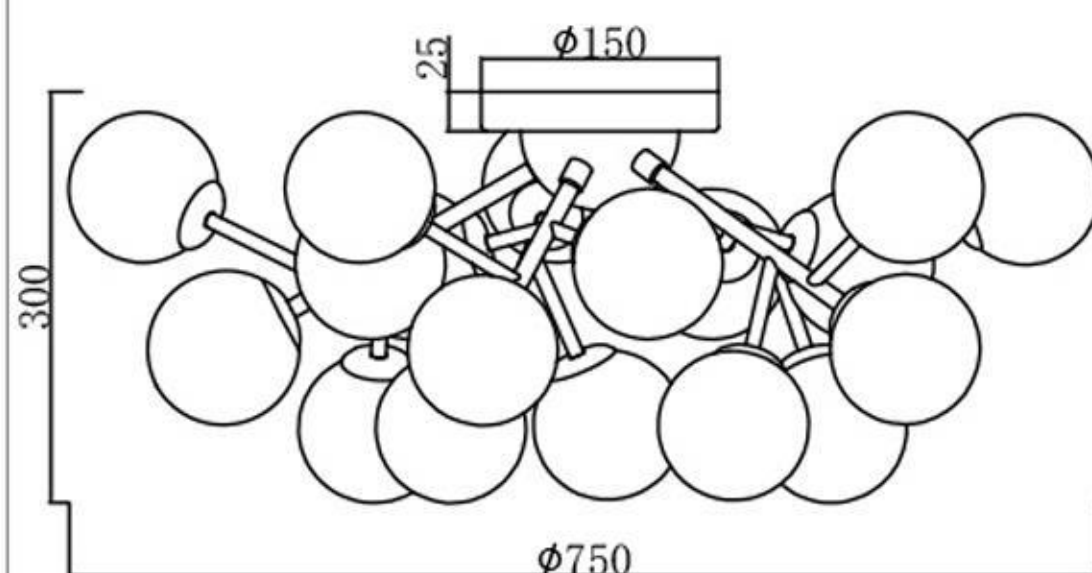

G9 20 x MAX 28W

ATTENTION:

1. In order to avoid getting hurt or scratching the finish while installing, please wear gloves.
2. Don't install any lamp on the wet or not complete dry ceiling.
3. Don't leave the lamps close to acidic and alkaline chemicals or gases which are corrosive. Don't wash the lamp by water. Please clean the lamp by a piece of clean, dry any soft cloth. Otherwise the lamp will get rusty.
4. Please take care while installing the lampshades in case of avoiding breakage.
5. Please install the lamp under the instructions of professional electricians.
6. While installing, the power leads must be matched well and tightly. Make sure all the screws are tight enough before turning on the power. Otherwise it will cause the electrical components burning because of the short circuit of the terminals.
7. Please switch off the power first before installing, cleaning the lamps or changing the bulbs.
8. Do not drag the wires and plugs overexertion. Disassembled at will is not allowed.
9. In order to avoid danger, the damaged extension electric wire should be replaced by relevant qualified personnel.