

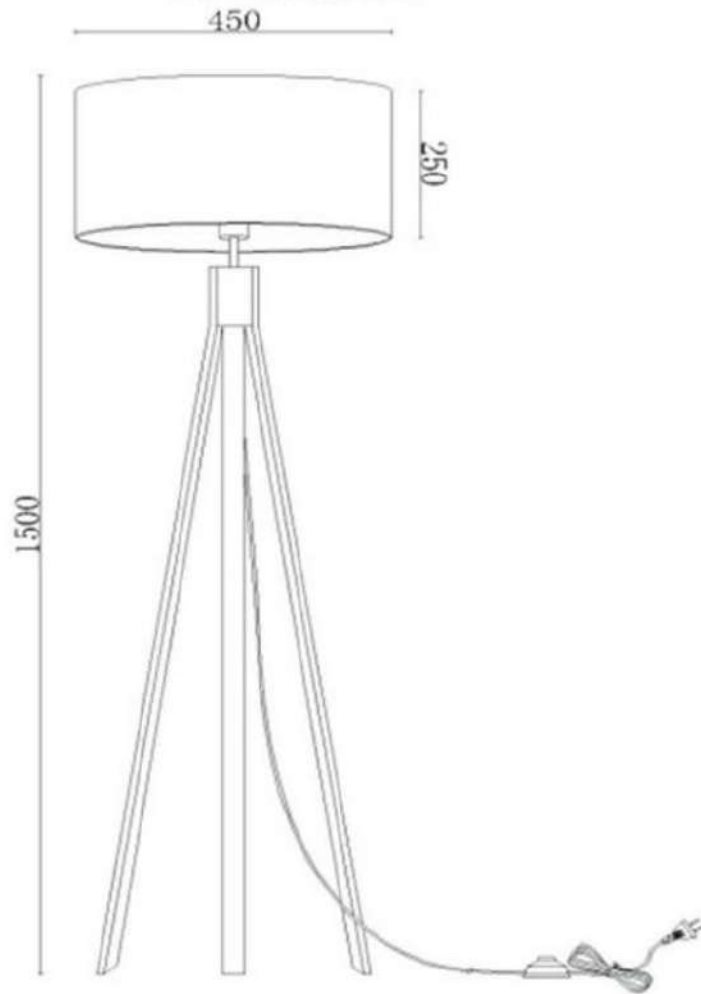

Model assembly instructions:
APL.636.05.01



1. Voltage/Frequency: 220-230V 50-60Hz.
2. Please wear gloves to install.
3. Don't install it on the moist ceiling.
4. Turn off the power before cleanout.
5. Please wash with the sanitizer without corrosivity.
6. The use of lamps is permissible: E27 1x40W.