

OML-67717-05

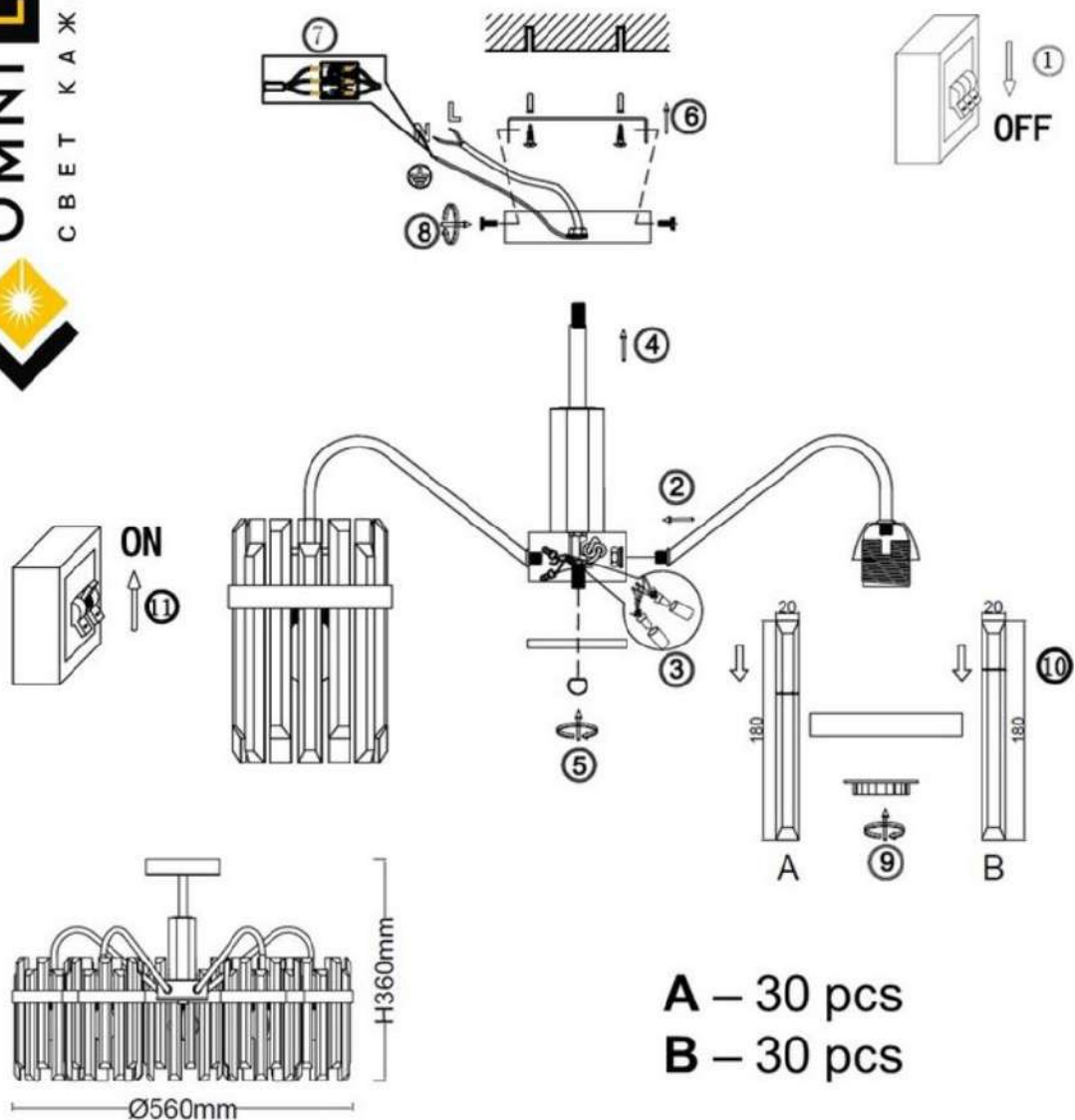

1. Before installing the luminaire, disconnect the power supply by turning the circuit breaker or fuse on the electrical panel box.
2. It is recommended to use gloves when assembling the luminaire.
3. Do not use a lamp with a higher wattage than indicated on the special sticker located on the lamp base.
4. When caring for the lamp, DO NOT use aggressive detergents.