

Item NO:SL1627.103.06

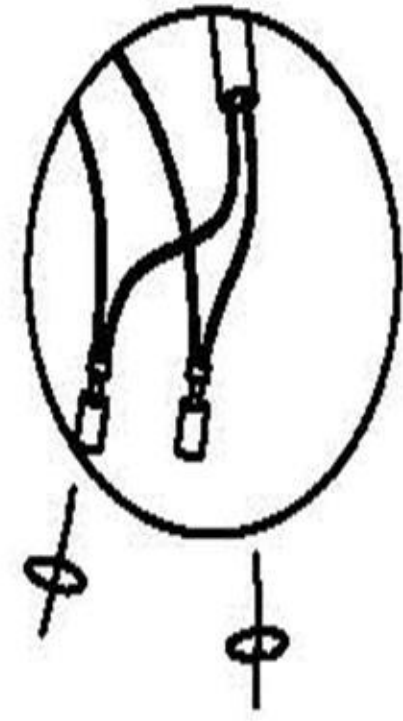

A

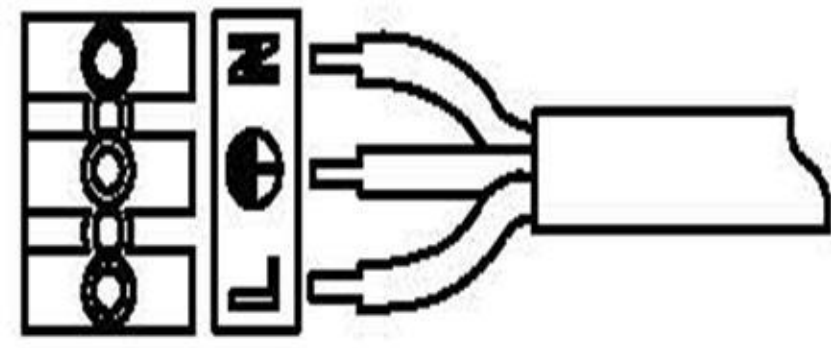
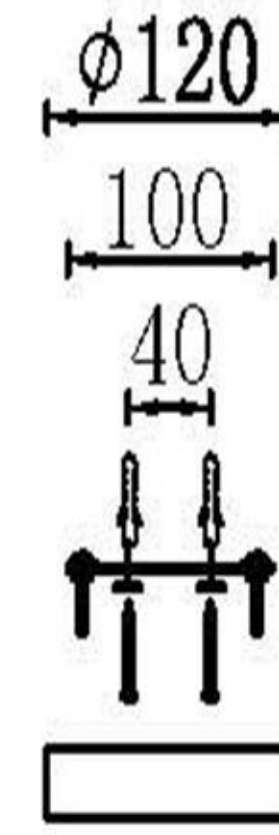

B

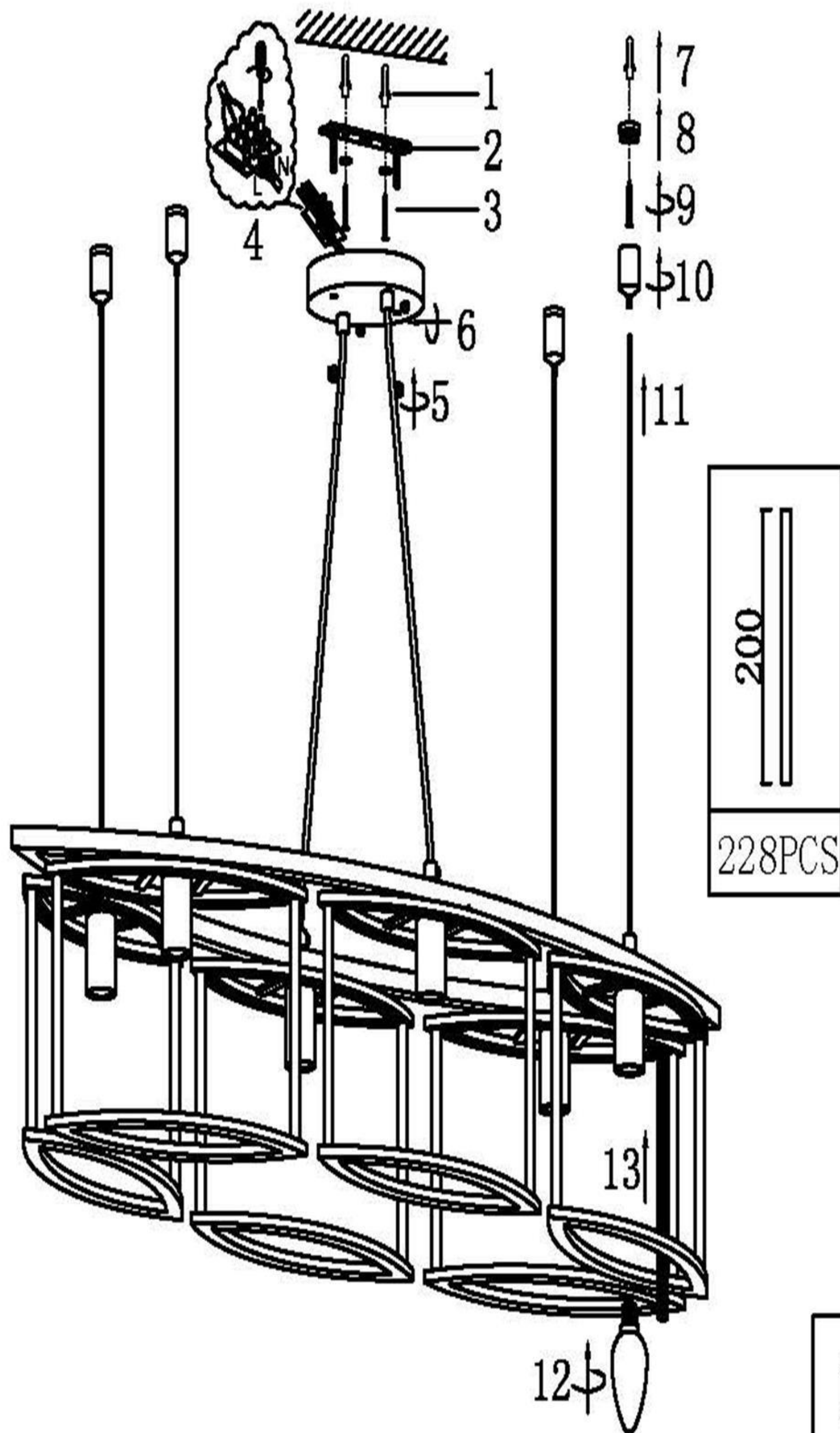

C

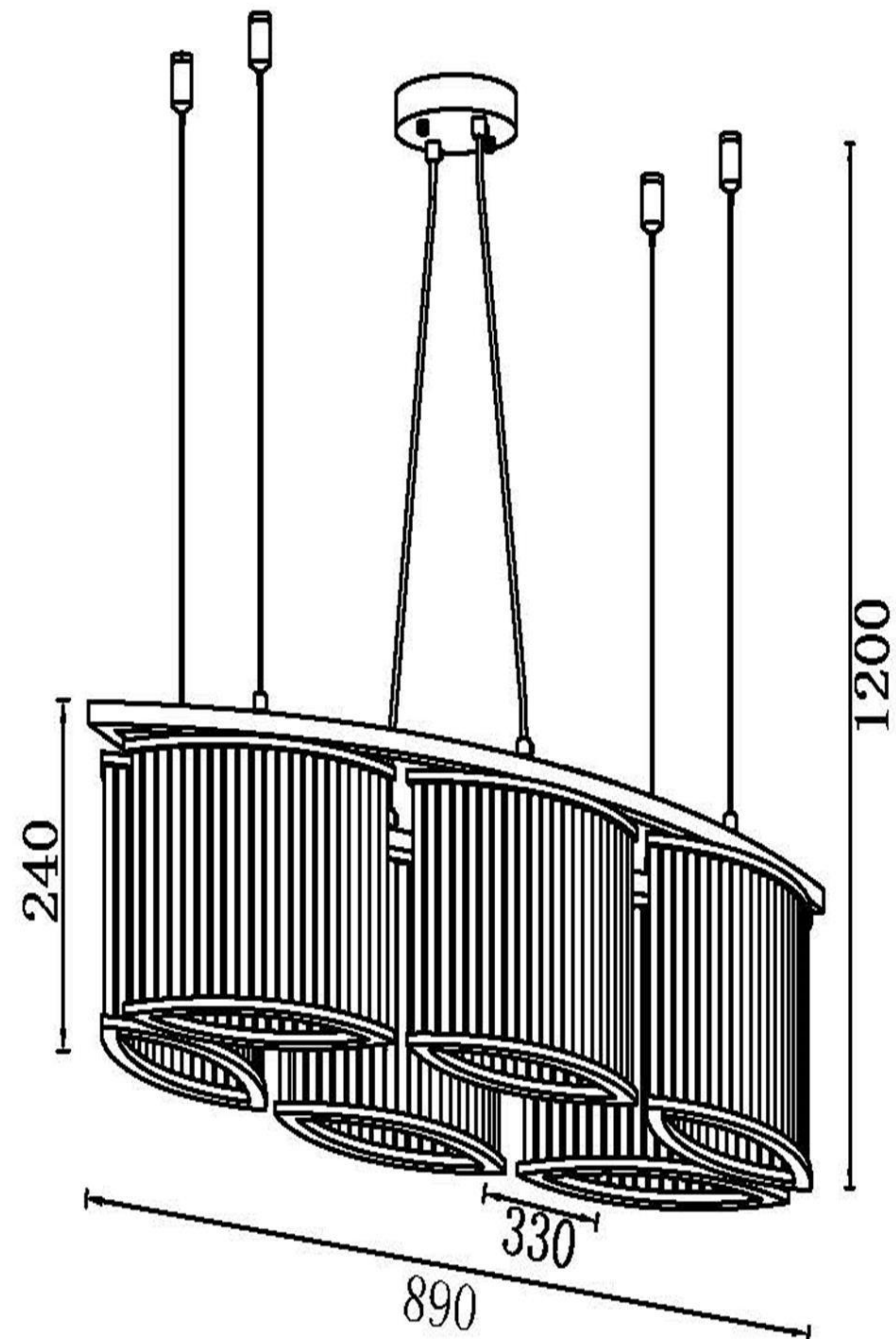

D