

Item NO:SL1803. 203. 02

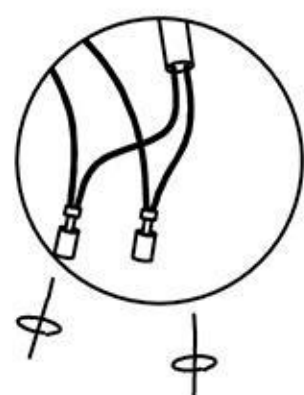

A

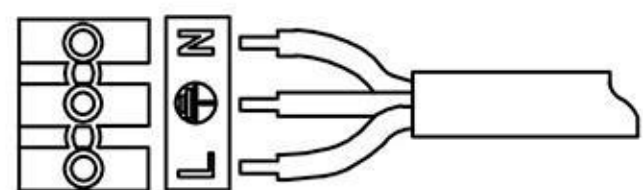
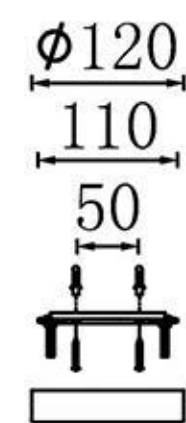

B

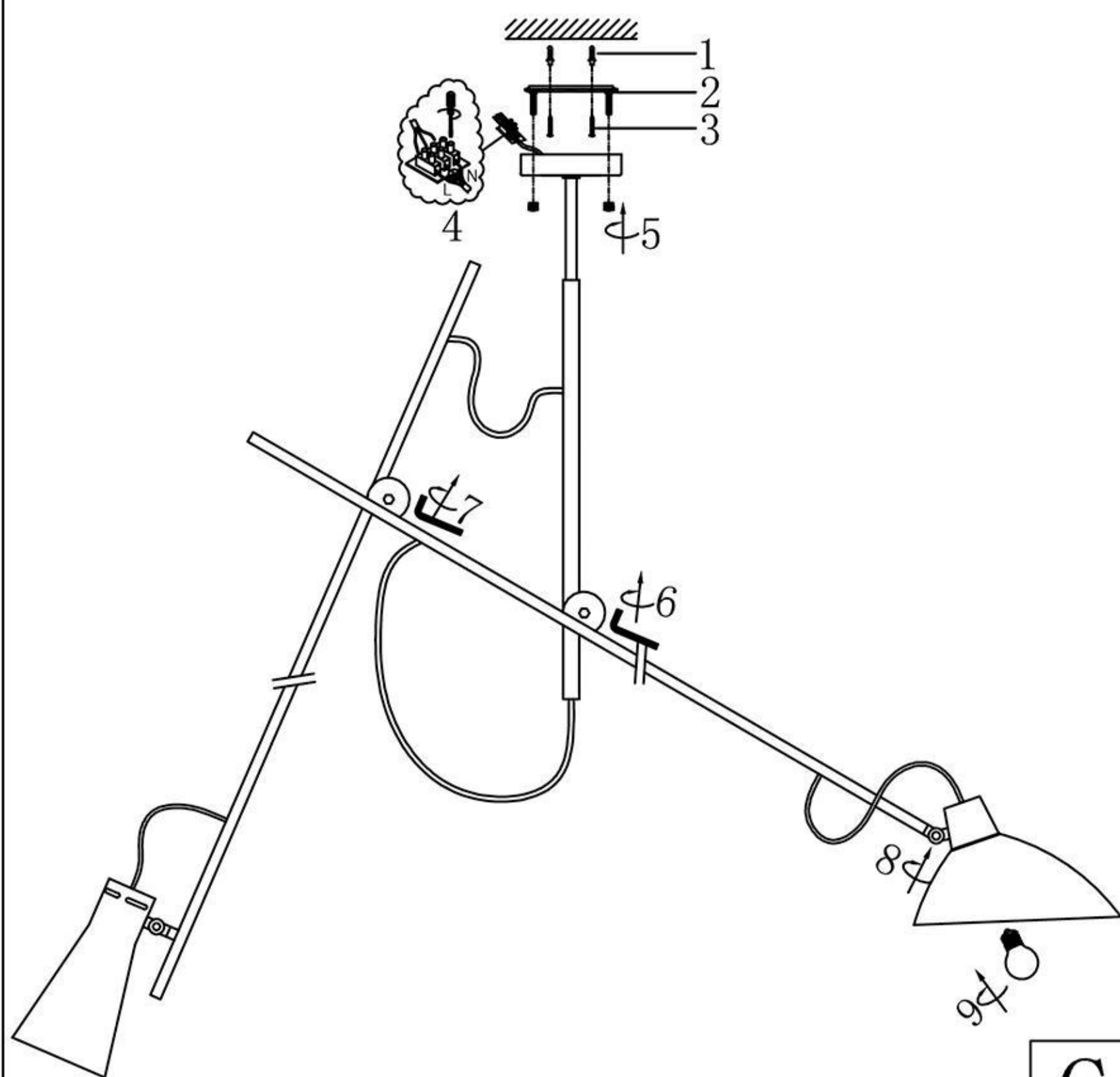

C

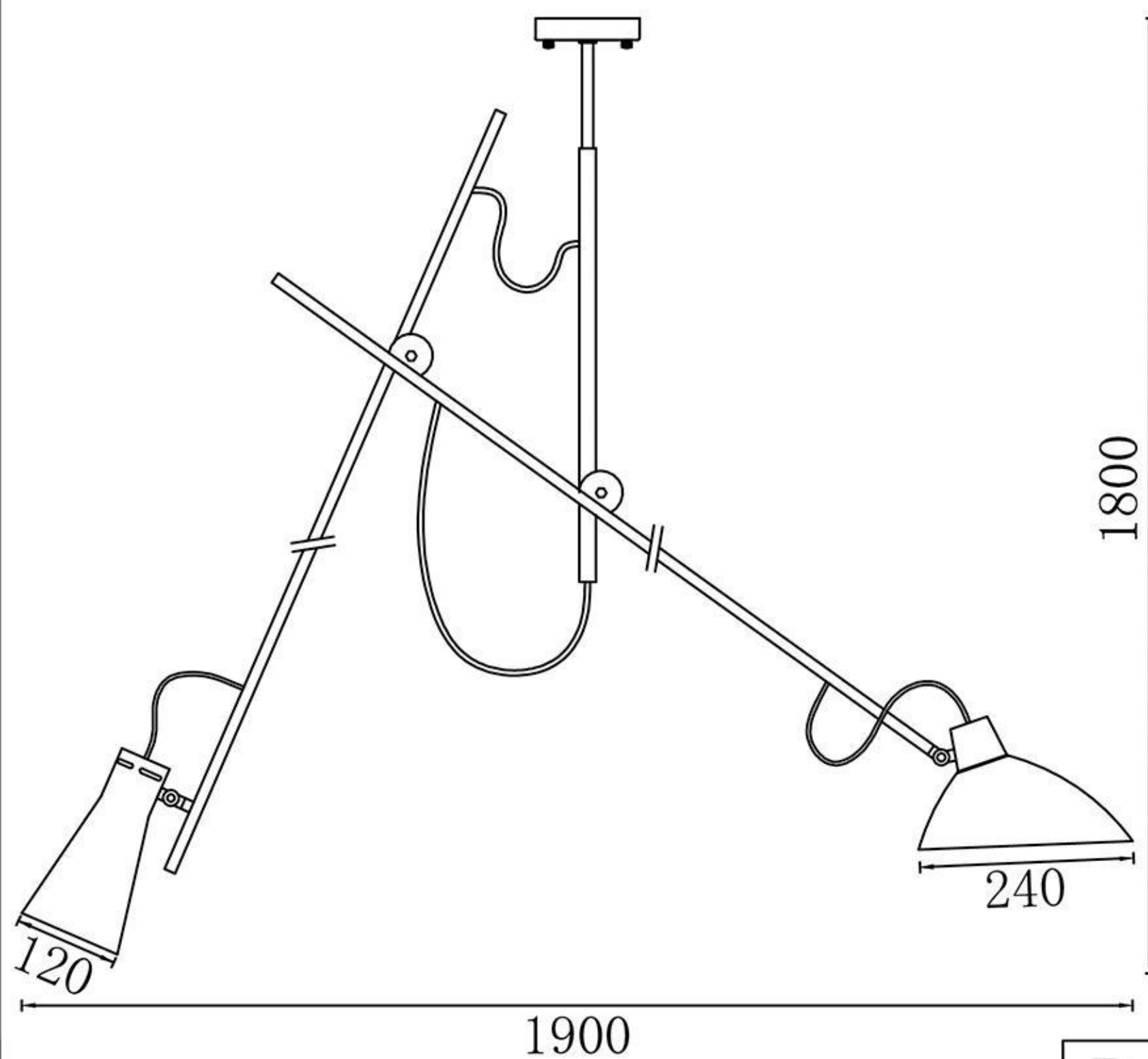

D