

Паспорт изделия
Гостиная Лира

2130	1680	350

67ГЛ / 2963
67ГЛЛ / 4071

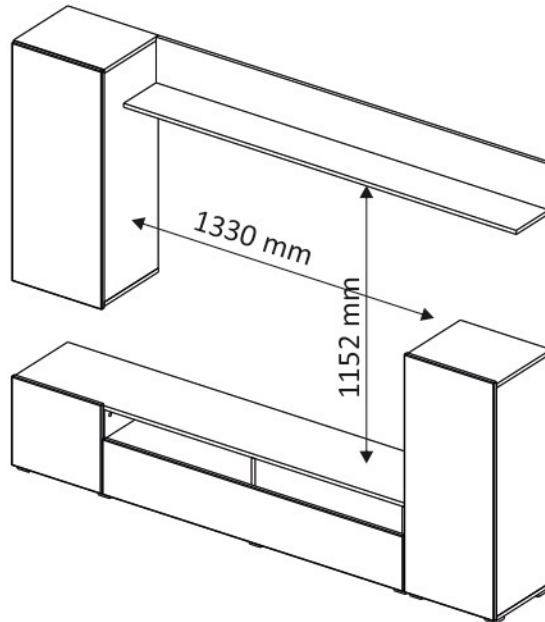

Комплектовочная ведомость / Set package sheet

Упак/ Package	Наименование	Description	Цвет детали/ Décor			Размер / Size, mm	Кол-во/ Quantity	№
			МДФ	ЛДСП				
			White - White gl	White- Concrete	White			
1	Фурнитура	Furniture/Cabinetry hardware	-			-	-	-
	Боковина (под петли)	Side (hinge)	White			920x334	2	5
	Крыша	Top				4	7	
	Боковина	Side				920x334	2	6
2	Крыша	Top	White			1730x334	1	8
	Боковина левая ср	Side left middle				320x330	1	2
	Боковина правая ср	Side right middle				320x330	1	3
	Вязка	Connecting element				366x334	1	10
	Вязка	Connecting element				649x330	1	11
	Боковина левая	Side left				320x330	1	1
	Боковина правая	Side right				320x330	1	4
	Вязка	Connecting element				366x334	1	10
	Вязка	Connecting element				649x330	1	11
	Крыша	Top				1730x330	1	9
3	Вязка	Connecting element	White			1730x200	1	12
	Задник	Back element				1730x200	1	13
4	ДВП	Back element	White	White	White	948x396	1	14
	Створка	Door	White gl	Concrete		958x396	1	17
	Створка	Door	White gl	Concrete		358x396	1	18
	ДВП	Back element	White	White		335x389	1	15
	Створка	Door	White gl	Concrete		958x396	1	17
	ДВП	Back element	White	White		948x396	1	14
5	Створка	Door	White gl	Concrete	White	1326x224	1	19
	ДВП	Back element	White	White		1334x214	1	16

(PL) Instrukcja montażu

(CZ) Návod k montáži

(D) Montageanleitung

(GB) Assembly instruction

(F) Model d'emploi

(HU) Szerelési útmutató

(I) Istruzione di montaggio

(NL) Handleiding voor de montage



(RU) Инструкция по монтажу

(RO) Instrucțiuni de montare

(SK) Návod k montáži

(TR) Montaj talimatı

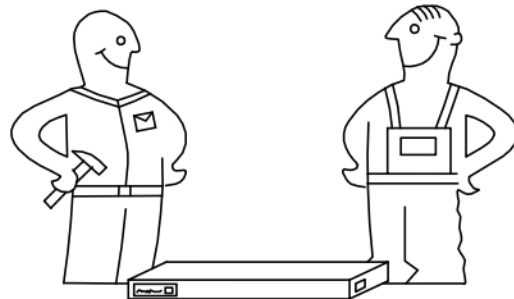
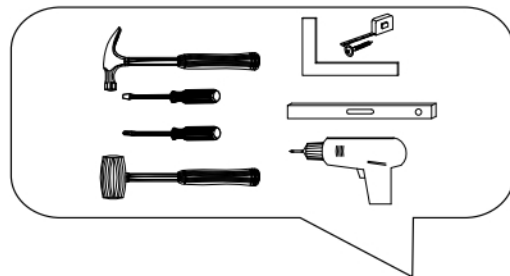



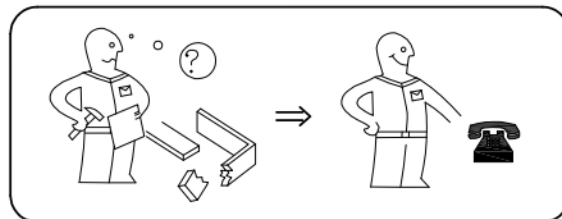
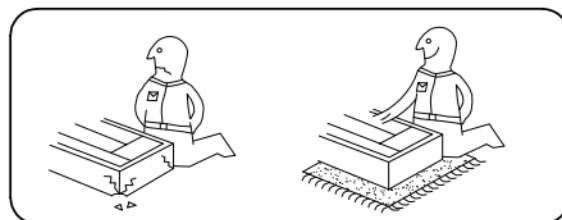



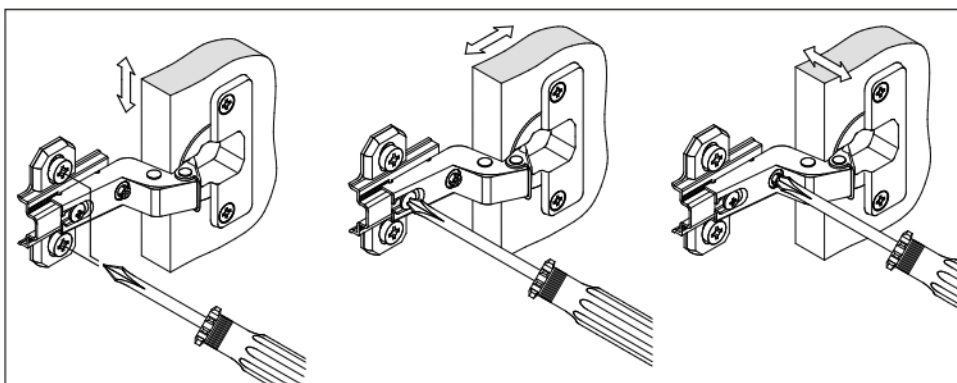
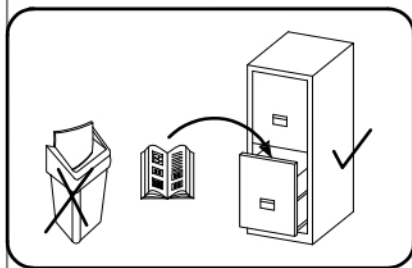

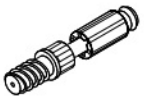

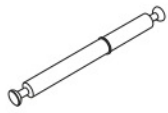

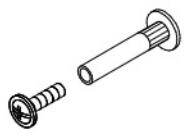
⚠ Uwaga • Upozornění • Achtung • Attention • Caution • Figyelem ⚠ Attenzione • Opgelet • Внимание • Atenție • Upozornenie • Dikkat	
PL	Czyszczenie należy wykonać wyłącznie za pomocą ściereczki lub lekko nawilżonego ręcznika. Nie stosować środków czyszczących do szorowania.
CZ	Čistění je nutné vykonávat výhradně pomocí utěrky nebo lehce navlhčeného ručníku. Nepoužívejte čističí prostředky obsahující abrazivní částice.
D	Bitte nur mit einem Staubtuch oder leicht feuchtem Lappen reinigen. Keine scheuernden Putzmittel verwenden.
GB	Please only clean with a duster or a damp cloth. Do not use any abrasive cleaners.
F	Le nettoyage se fait uniquement à l'aide d'un torchon ou d'une serviette légèrement mouillée.
HU	A tisztítás kizárólag törölruha vagy enyhén nedvesített törölköző segítségével végezhető. Súroló hatású tisztítószereket nem szabad használni.
I	Pulire esclusivamente con un panno o un asciugamano umido.
NL	Reinig alleen met een stofdoek of een lichtjes vochtige doek. Gebruik geen schurende poetsmiddelen.
RU	Очищайте от пыли тряпкой или слегка влажной ветошью. Не допускается применение чистящих средств, не предназначенных для ухода за мебелью.
RO	Curățarea trebuie efectuată numai cu o cârpă sau cu un prosop ușor umezit. Nu utilizați agenți de curățare abrazivi.
SK	Čistení je nutné vykonávať výhradne pomocí utierky alebo ľahko zvlhnutým ručníkom. Nepoužívajte čistiace prostriedky obsahujúce abrazívne častice.
TR	Lütfen sadece bir toz bezilye veya hafif nemli yumuşak bir bezle siliniz. Aşındırıcı temizlik malzemeleri kullanmayınız.

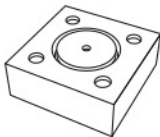

**Karta serwisowa • Servisní list • Service Karte • Service card • Carte de service • Szervizkártya
Scheda di servizio • Service kaart • Сервисная карта • Fisa service • Servisný list • Servis karti**

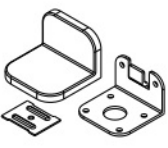
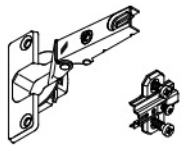
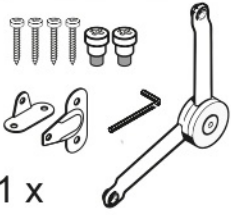

1		2		3		4		5	7x50
									
36 x		40 x		5 x		2 x		13 x	
6	6,3x10,5	9		10	3,5x25	15		18	3,5x15
									
18 x		2 x		8 x		1 x		85 x	
31	SAH302	38		48	2x20	53		73	
									
2 x		12 x		70 x		2 x		40 x	
69		91	Hinge A	97					
									
1 x		9 x		1 x					

